













**IŞIKLIK SİSTEMİ**  
SKYLIGHT SYSTEMS

**SKY50**  
**IŞIKLIK SİSTEMİ**  
SKYLIGHT SYSTEMS



**SKY50**  
**İŞIKLIK SİSTEMİ**  
SKYLIGHT SYSTEMS

**ÜRÜN TEKNİK ÖZELLİKLERİ**  
PRODUCT'S TECHNICAL FEATURES

No. Nr.	PROFİL KESİTİ PROFILE VIEW	PROFİL NO PROFILE NO	PROFİL AÇIKLAMASI PROFILE DESCRIPTION	BAĞLANTI PARÇALARI CORNER CLEATS	gr/m	STATİK STATIC			
						$I_x$ cm <sup>4</sup>	$I_y$ cm <sup>4</sup>	$W_x$ cm <sup>3</sup>	$W_y$ cm <sup>3</sup>
11		<b>SK78-303</b> ( 50 - 12 ) ( 13 mm )	<b>KAPAK PROFİLİ</b> COVER PROFILE	SK78-304	233				
12		<b>SK78-304</b> ( 46.6 - 9 ) ( 2 mm )	<b>BASKI PROFİLİ</b> PRESSURE PROFILE		388				
13		<b>KC0301</b> ( 46.9 - 9 ) ( 2 mm )	<b>BASKI PROFİLİ</b> PRESSURE PROFILE		496				
14		<b>KC0307</b> ( 95.8 - 29.2 )	<b>45° - BASKI PROFİLİ</b> 45°-PRESSURE PROFILE	KC0318	786				
15		<b>KC0310</b> ( 192 mm60 ) ( 15 mm )	<b>KAPAK PROFİLİ</b> COVER PROFILE	KC0301	308				
16		<b>KC0318</b> ( 123.5 - 37.6 ) ( 15 mm )	<b>45° - KAPAK PROFİLİ</b> 45°-COVER PROFILE	KC0307	912				
17	  İşaretili profil için satış ekibinden bilgi alınız.	<b>KC0327</b> ( 77.6 - 26 ) ( 15 mm )	<b>15° - KAPAK PROFİLİ</b> 15°-COVER PROFILE	KC0328	562				
18	  İşaretili profil için satış ekibinden bilgi alınız.	<b>KC0328</b> ( 66.3 - 17.7 ) ( 15 mm )	<b>15° - BASKI PROFİLİ</b> 15°-PRESSURE PROFILE	KC0327	524				
19		<b>KC0329</b> ( 99.5 - 33.2 ) ( 15 mm )	<b>30° - KAPAK PROFİLİ</b> 30°-COVER PROFILE	KC0330	674				
20		<b>KC0330</b> ( 79.3 - 24.7 ) ( 15 mm )	<b>30° - BASKI PROFİLİ</b> 30°-PRESSURE PROFILE	KC0329	614				

Profil değerleri teoriktir. Ağırlık olarak testimde yapılan tartım geçerlidir.  
Profil imatları TS EN 12020-2 ve TS EN 755-9 toleransı,  
Moment değerleri EN 14024'e göre hesaplanmıştır.

Profile values are theoretical pre-shipment weight will be valid.  
The tolerances of Profile manufacturing are calculated according to EN 12020-2  
and TS EN 755-9; moment values are calculated according to EN 14024.

**SKY50**  
**İŞIKLIK SİSTEMİ**  
**SKYLIGHT SYSTEMS**

**ÜRÜN TEKNİK ÖZELLİKLERİ**  
**PRODUCT'S TECHNICAL FEATURES**



No. Nr.	PROFİL KESİTİ PROFILE VIEW	PROFİL NO PROFILE NO	PROFİL AÇIKLAMASI PROFILE DESCRIPTION	BAĞLANTI PARÇALARI CORNER CLEATS	gr/m	STATİK STATIC			
						Ix cm <sup>4</sup>	Iy cm <sup>4</sup>	Wx cm <sup>3</sup>	Wy cm <sup>3</sup>
21		<b>KC0331</b> ( 20 - 11 ) (12 mm)	<b>TEK CAM ADAPTÖRÜ PR.</b> SINGLE GLAZING ADAPTER PROFILE		207				
22		<b>KC0332</b> ( 22 - 11 ) (12 mm)	<b>TEK CAM ADAPTÖRÜ PR.</b> SINGLE GLAZING ADAPTER PROFILE		218				
23		<b>KC0333</b> ( 16 - 11 ) (12 mm)	<b>TEK CAM ADAPTÖRÜ PR.</b> SINGLE GLAZING ADAPTER PROFILE		179				
24		<b>KC0334</b> ( 18 - 11 ) (12 mm)	<b>TEK CAM ADAPTÖRÜ PR.</b> SINGLE GLAZING ADAPTER PROFILE		192				
25		<b>KC0340</b> ( 10.7 - 8.3 ) (12 mm)	<b>15° - ADAPTÖR PROFİLİ</b> 15°-ADAPTER PROFILE		98				
26		<b>KC0341</b> ( 10.7 - 10.3 ) (12 mm)	<b>30° - ADAPTÖR PROFİLİ</b> 30°-ADAPTER PROFILE		105				
27		<b>KC0342</b> ( 10.7 - 11.9 ) (12 mm)	<b>45° - ADAPTÖR PROFİLİ</b> 45°-ADAPTER PROFILE		112				
28		<b>KC0343</b> ( 10.7 - 13.6 ) (12 mm)	<b>60° - ADAPTÖR PROFİLİ</b> 60°-ADAPTER PROFILE		123				
29	  İşaretili profil için satış ekibinden bilgi alınız.	<b>KC0344</b> ( 140.7 - 49.7 ) (15 mm)	<b>60° - KAPAK PROFİLİ</b> 60°-COVER PROFILE	KC0345	994				
30	  İşaretili profil için satış ekibinden bilgi alınız.	<b>KC0345</b> ( 106.4 - 40.3 ) (15 mm)	<b>60° - BASKI PROFİLİ</b> 60°-PRESSURE PROFILE	KC0343	903				

Profil değerleri teoriktir. Ağırlık olarak testimde yapılan tartım geçerlidir.  
Profil imalatları TS EN 12020-2 ve TS EN 755-9 toleransları,  
Moment değerleri EN 14024'e göre hesaplanmıştır.

Profile values are theoretical pre-shipment weight will be valid.  
The tolerances of Profile manufacturing are calculated according to EN 12020-2  
and TS EN 755-9; moment values are calculated according to EN 14024.

**SKY50**  
**İŞIKLIK SİSTEMİ**  
SKYLIGHT SYSTEMS

**ÜRÜN TEKNİK ÖZELLİKLERİ**  
PRODUCT'S TECHNICAL FEATURES

No. Nr.	PROFİL KESİTİ PROFILE VIEW	PROFİL NO PROFILE NO	PROFİL AÇIKLAMASI PROFILE DESCRIPTION	BAĞLANTI PARÇALARI CORNER CLEATS	gr/m	STATİK STATIC			
						$I_x$ cm <sup>4</sup>	$I_y$ cm <sup>4</sup>	$W_x$ cm <sup>3</sup>	$W_y$ cm <sup>3</sup>
31		<b>KC0350</b> ( 6 - 11 ) ( 1 mm )	<b>TEK CAM ADAPTÖRÜ PR.</b> SINGLE GLAZING ADAPTER PROFILE		96				
32		<b>KC0351</b> ( 14 - 11 ) ( 12 mm )	<b>TEK CAM ADAPTÖRÜ PR.</b> SINGLE GLAZING ADAPTER PROFILE		151				
33	  İşaretili profil için satış ekibinden bilgi alınız.	<b>KC0352</b> ( 35 - 50 ) ( 17 mm )	<b>TEK CAM ADAPTÖRÜ PR.</b> SINGLE GLAZING ADAPTER PROFILE		270				
34	  İşaretili profil için satış ekibinden bilgi alınız.	<b>SK50-301</b> ( 22 - 44 ) ( 3 mm )	<b>TAŞIYICI BAĞ. PR.</b> T-CONNECTOR FOR TRANSOM PROFILE		731				
35		<b>SC0309</b> ( 55 - 55 ) ( 6.9 mm )	<b>KÖŞE BİRLEŞTİRME PROFİLİ</b> CORNER CLEATS PROFILE		1573				
36		<b>EC0201</b> ( 19.3 - 17 ) ( 12 mm )	<b>ÇİFT CAM İÇİ PANEL PR.</b> PANEL PROFILE FOR DOUBLE GLASS		220				
37		<b>EC0301</b> ( 22.1 - 10.7 ) ( 12 mm )	<b>BAĞLANTI PROFİLİ</b> CONNECTION PROFILE		223				
38									
39									
40									

Profil değerleri teoriktir. Ağırlık olarak testimde yapılan tartım geçerlidir.  
Profil imalatları TS EN 12020-2 ve TS EN 755-9 toleransı,  
Moment değerleri EN 14024'e göre hesaplanmıştır.

Profile values are theoretical pre-shipment weight will be valid.  
The tolerances of Profile manufacturing are calculated according to EN 12020-2  
and TS EN 755-9; moment values are calculated according to EN 14024.

**SKY50**  
**İŞIKLIK SİSTEMİ**  
SKYLIGHT SYSTEMS

ÜRÜN TEKNİK ÖZELLİKLERİ  
PRODUCT'S TECHNICAL FEATURES

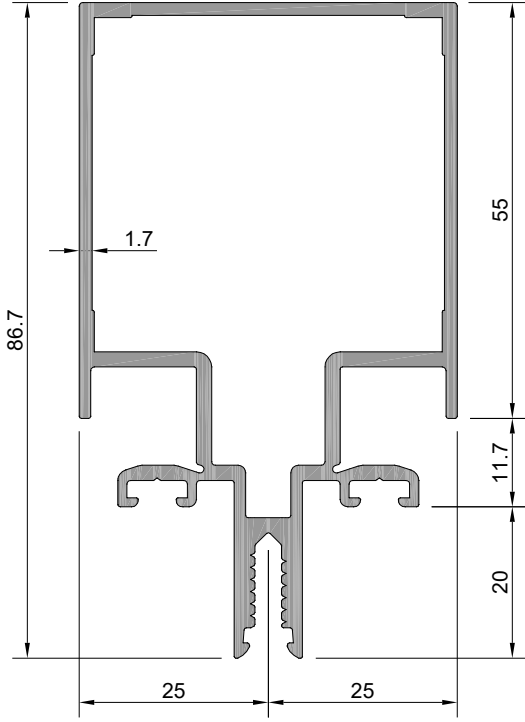

Profil No: SK50-101

Ağırlık : 1579 gr/m

$I_x$  : 40,15 cm<sup>4</sup>

$I_y$  : 16,21 cm<sup>4</sup>

$W_x$  : 9,05 cm<sup>3</sup>

$W_y$  : 6,48 cm<sup>3</sup>

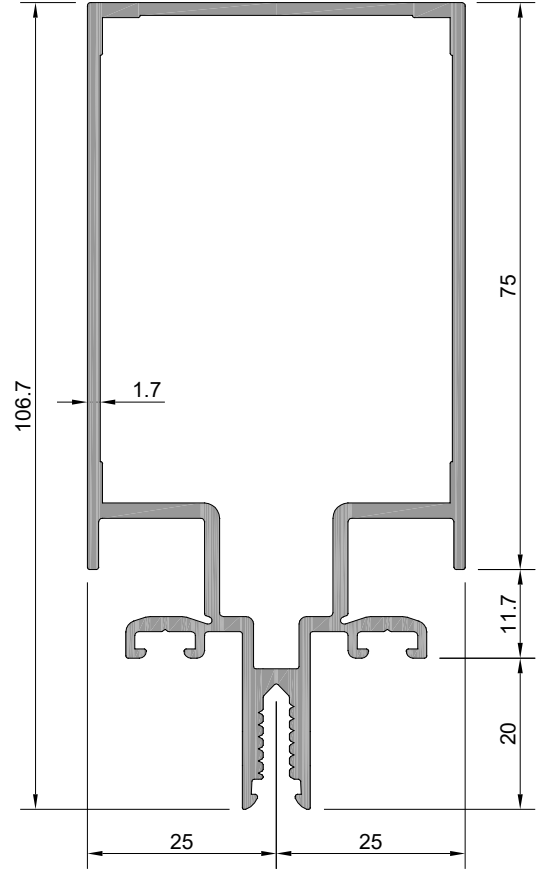

Profil No: SK50-102

Ağırlık : 1764 gr/m

$I_x$  : 72,25 cm<sup>4</sup>

$I_y$  : 20,18 cm<sup>4</sup>

$W_x$  : 13,32 cm<sup>3</sup>

$W_y$  : 6,48 cm<sup>3</sup>

# SKY50 IŞIKLIK SİSTEMİ

ÜRÜN TEKNİK ÖZELLİKLERİ  
PRODUCT'S TECHNICAL FEATURES

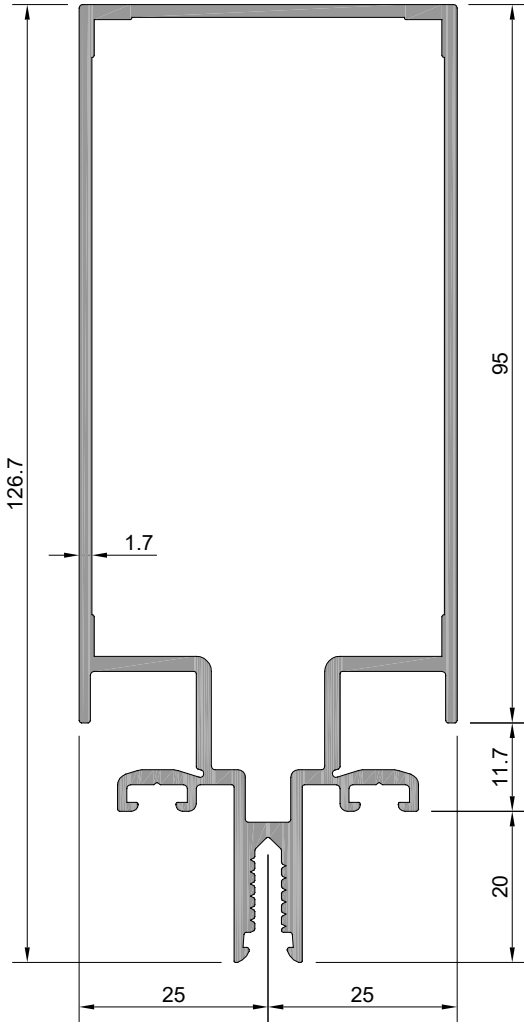

Profil No: SK50-103

Ağırlık : 1948 gr/m

$I_x$  : 116,95  $cm^4$

$I_y$  : 24,14  $cm^4$

$W_x$  : 17,77  $cm^3$

$W_y$  : 9,66  $cm^3$

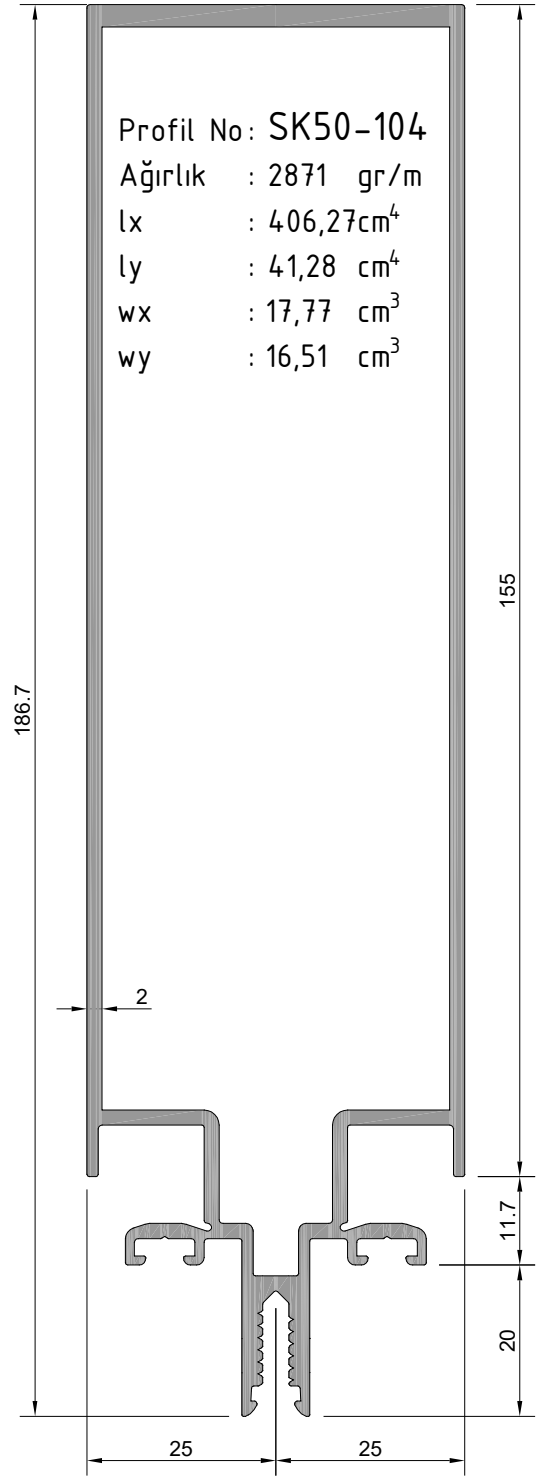

Profil No: SK50-104

Ağırlık : 2871 gr/m

$I_x$  : 406,27  $cm^4$

$I_y$  : 41,28  $cm^4$

$W_x$  : 17,77  $cm^3$

$W_y$  : 16,51  $cm^3$

# SKY50 IŞIKLIK SİSTEMİ

ÜRÜN TEKNİK ÖZELLİKLERİ  
PRODUCT'S TECHNICAL FEATURES

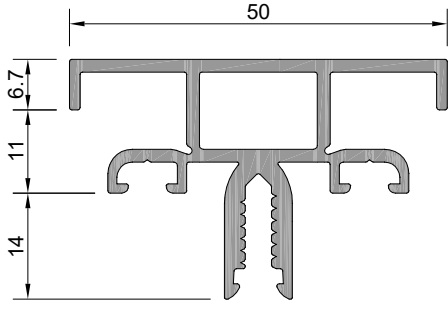

Profil No: SK50-110  
Ağırlık : 839 gr/m  
Ix : 2,34 cm<sup>4</sup>  
Iy : 4,31 cm<sup>4</sup>  
wx : 1,15 cm<sup>3</sup>  
wy : 1,73 cm<sup>3</sup>

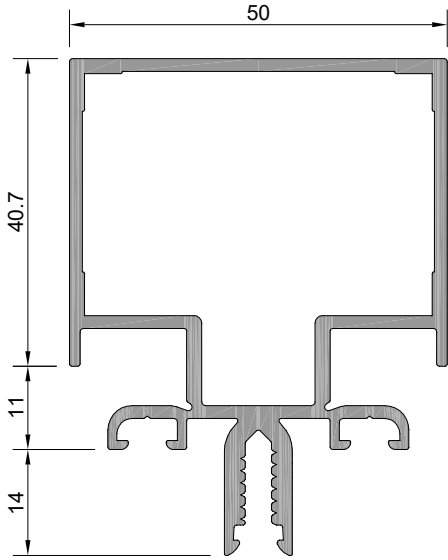

Profil No: SK50-111  
Ağırlık : 1342 gr/m  
Ix : 19,74 cm<sup>4</sup>  
Iy : 12,96 cm<sup>4</sup>  
wx : 5,76 cm<sup>3</sup>  
wy : 5,18 cm<sup>3</sup>



SK50-301-a

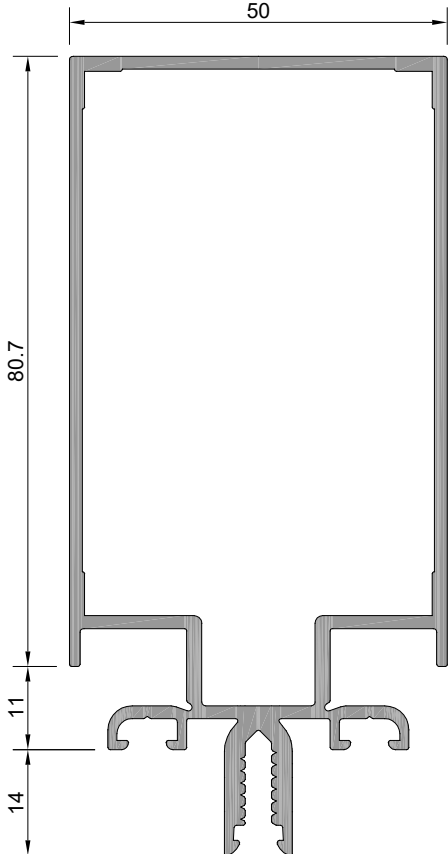

Profil No: SK50-112  
Ağırlık : 1711 gr/m  
Ix : 74,76 cm<sup>4</sup>  
Iy : 20,89 cm<sup>4</sup>  
wx : 13,60 cm<sup>3</sup>  
wy : 8,35 cm<sup>3</sup>



SK50-301-b



# SKY50 IŞIKLIK SİSTEMİ

ÜRÜN TEKNİK ÖZELLİKLERİ  
PRODUCT'S TECHNICAL FEATURES

Profil No: ŞK78-201

Ağırlık PVC :	2187	gr/m
Ağırlık POLY:	2179	gr/m

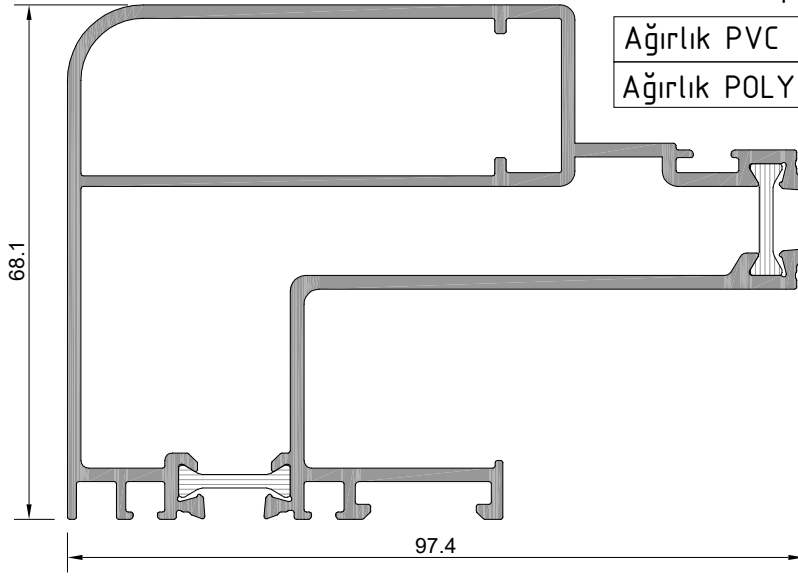

SC0309-d

Profil No: ŞK78-202

Ağırlık PVC :	1250	gr/m
Ağırlık POLY:	1241	gr/m

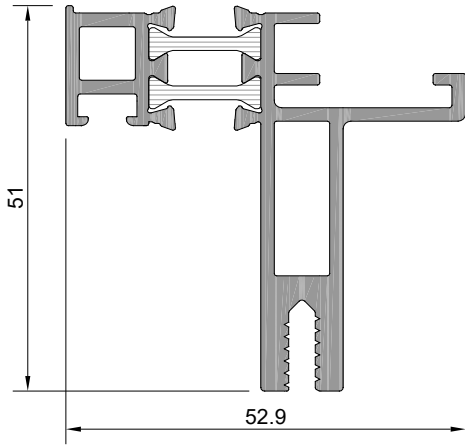

SC0309-a



SC0309-d

Profil No: SK78-203

Ağırlık : 598 gr/m

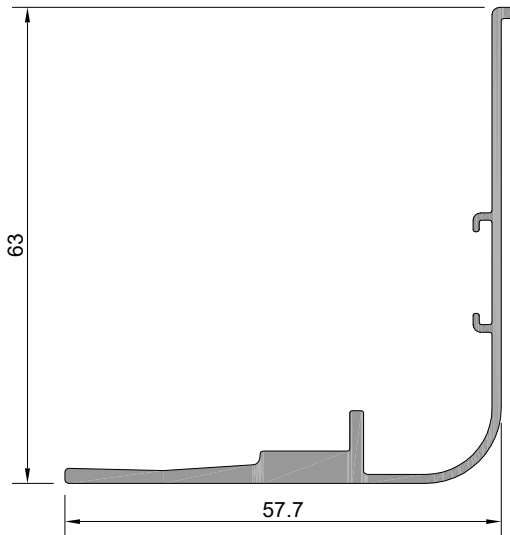

# SKY50 IŞIKLIK SİSTEMİ

ÜRÜN TEKNİK ÖZELLİKLERİ  
PRODUCT'S TECHNICAL FEATURES

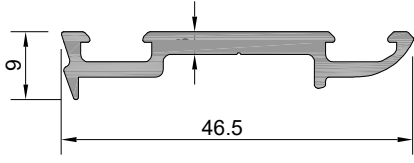

Profil No: SK78-304  
Ağırlık : 388 gr/m

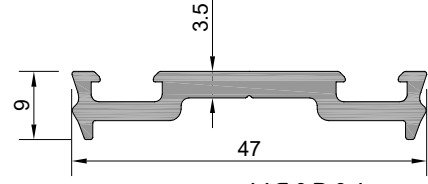

Profil No: KC0301  
Ağırlık : 496 gr/m

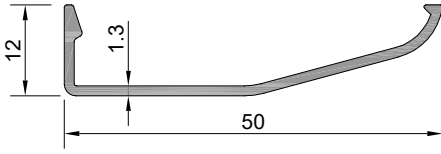

Profil No: SK78-303  
Ağırlık : 233 gr/m

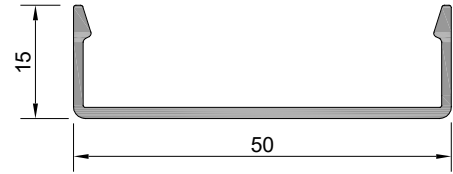

Profil No: KC0310  
Ağırlık : 308 gr/m

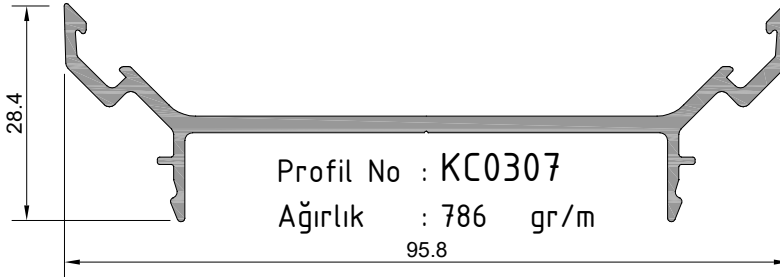

Profil No : KC0307  
Ağırlık : 786 gr/m

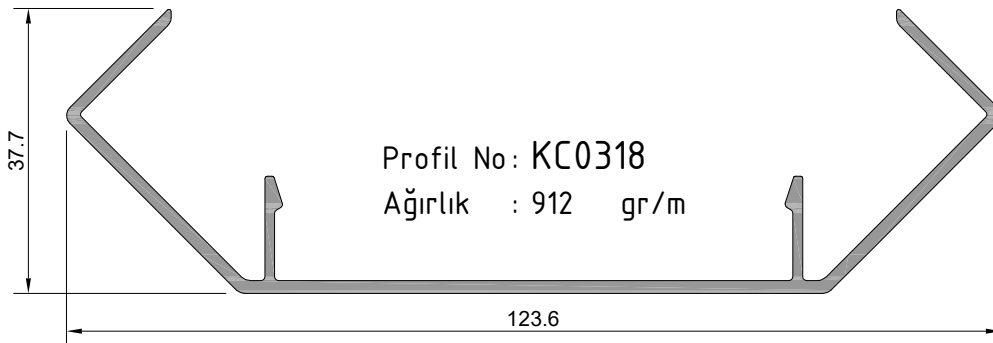

Profil No: KC0318  
Ağırlık : 912 gr/m

**SKY50**  
**İŞIKLIK SİSTEMİ**  
SKYLIGHT SYSTEMS

ÜRÜN TEKNİK ÖZELLİKLERİ  
PRODUCT'S TECHNICAL FEATURES

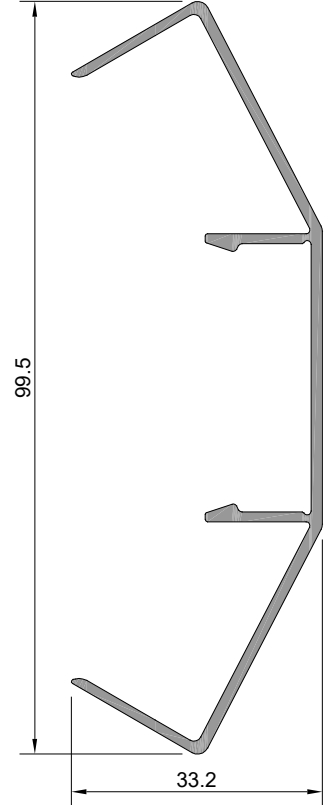
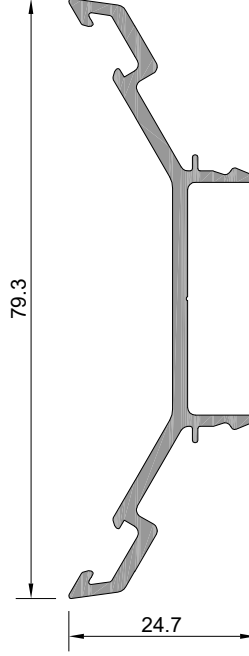
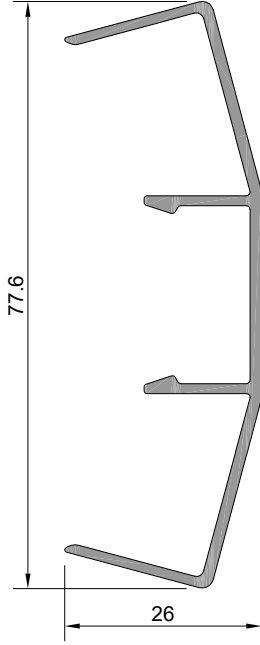
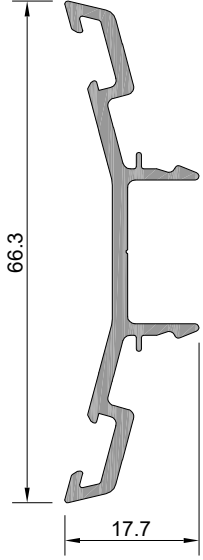

Profil No : KC0328 ⚠

Ağırlık : 524 gr/m

Profil No : KC0327 ⚠

Ağırlık : 562 gr/m

Profil No : KC0330

Ağırlık : 614 gr/m

Profil No : KC0329

Ağırlık : 674 gr/m

⚠ İşaretili profil için satış ekibinden bilgi alınız.

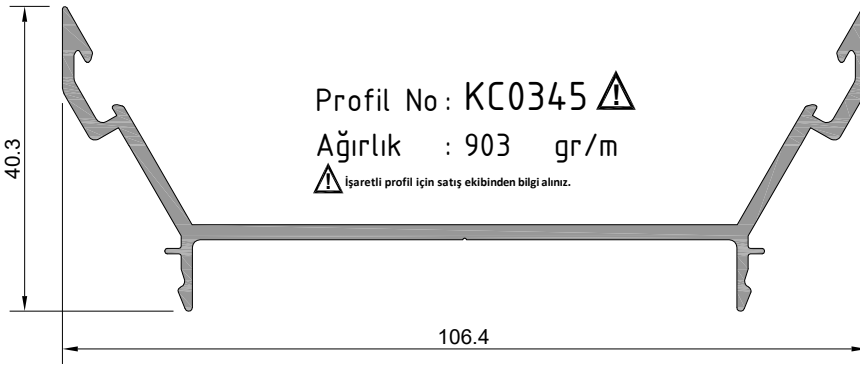

Profil No : KC0345 ⚠

Ağırlık : 903 gr/m

⚠ İşaretili profil için satış ekibinden bilgi alınız.

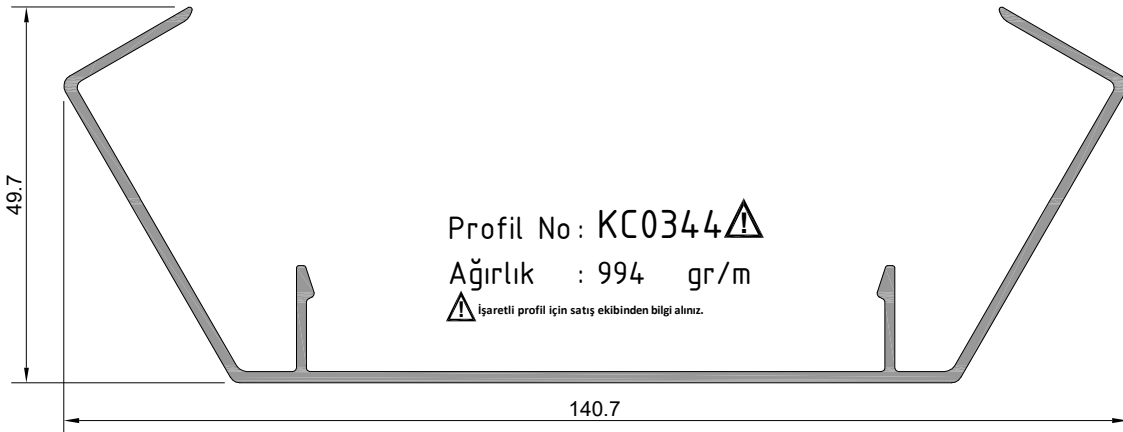

Profil No : KC0344 ⚠

Ağırlık : 994 gr/m

⚠ İşaretili profil için satış ekibinden bilgi alınız.

**SKY50**  
**İŞIKLIK SİSTEMİ**  
SKYLIGHT SYSTEMS

ÜRÜN TEKNİK ÖZELLİKLERİ  
PRODUCT'S TECHNICAL FEATURES

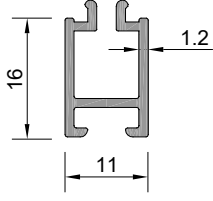

Profil No : KC0333  
Ağırlık : 179 gr/m

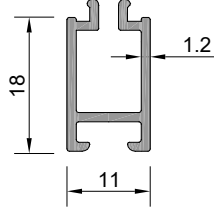

Profil No : KC0334  
Ağırlık : 192 gr/m

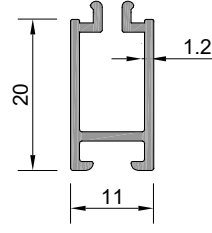

Profil No : KC0331  
Ağırlık : 207 gr/m

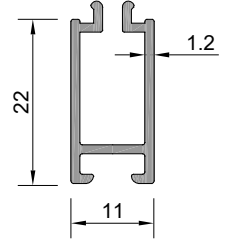

Profil No : KC0332  
Ağırlık : 218 gr/m

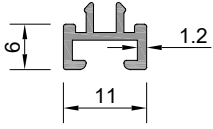

Profil No : KC0350  
Ağırlık : 96 gr/m

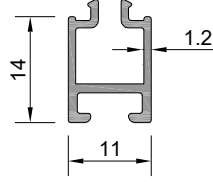

Profil No : KC0351  
Ağırlık : 151 gr/m

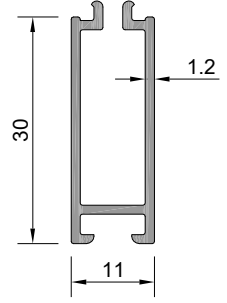

Profil No : KC0352 ⚠  
Ağırlık : 270 gr/m  
⚠ İşaretili profil için satış ekibinden bilgi alınız.

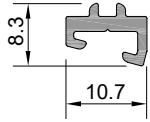

Profil No : KC0340  
Ağırlık : 98 gr/m

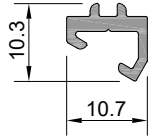

Profil No : KC0341  
Ağırlık : 105 gr/m

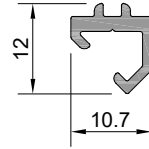

Profil No : KC0342  
Ağırlık : 112 gr/m

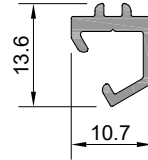

Profil No : KC0343  
Ağırlık : 123 gr/m

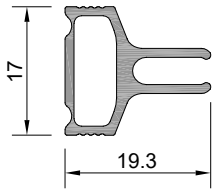

Profil No : EC0201  
Ağırlık : 220 gr/m

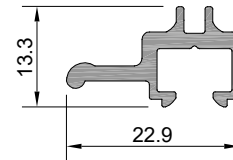
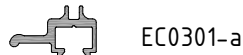

Profil No : EC0301  
Ağırlık : 223 gr/m

EC0301-a	50 mm	100 adet/pcs
----------	-------	--------------

# SKY50 IŞIKLIK SİSTEMİ

ÜRÜN TEKNİK ÖZELLİKLERİ  
PRODUCT'S TECHNICAL FEATURES

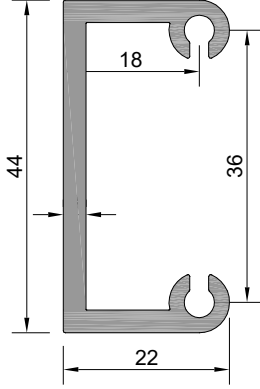

Profil No: SK50-301 

Ağırlık : 731 gr/m

 İşaretili profil için satış ekibinden bilgi alınır.

SK50-301-a	31.5mm	100 adet/pcs
SK50-301-b	71.5mm	100 adet/pcs

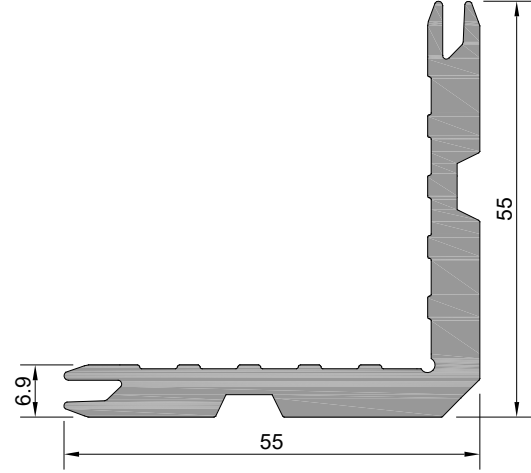

Profil No: SC0309

Ağırlık : 1573 gr/m

SC0309-a	6.5mm	100 adet/pcs
SC0309-b	8.5mm	100 adet/pcs
SC0309-c	18.9mm	100 adet/pcs
SC0309-d	20mm	100 adet/pcs
SC0309-e	25.3mm	100 adet/pcs

SC0309-f	4.7mm	100 adet/pcs
SC0309-g	54.2mm	100 adet/pcs
SC0309-h	23.8mm	100 adet/pcs
SC0309-ı	48.2mm	100 adet/pcs

**SKY50**  
**İŞIKLIK SİSTEMİ**  
SKYLIGHT SYSTEMS

**SABİT - SABİT**  
FIXED-FIXED

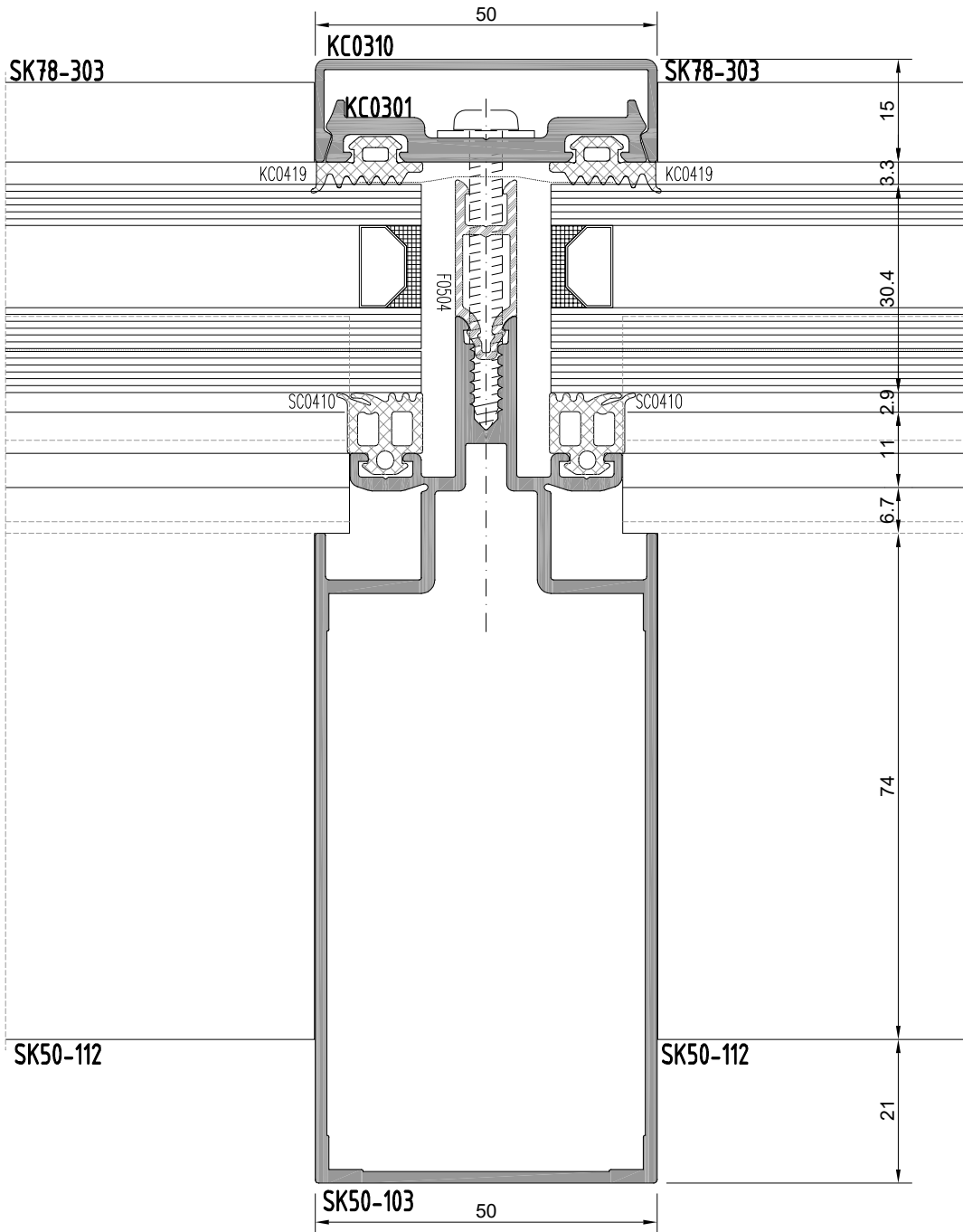
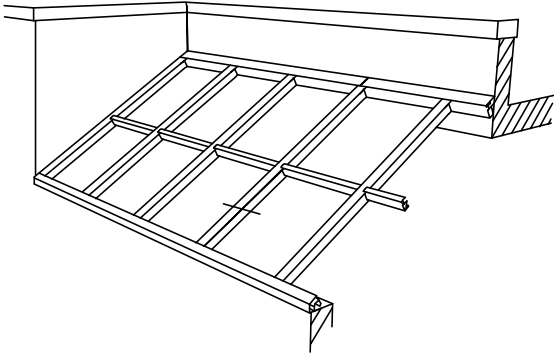

**SKY50**  
**İŞIKLIK SİSTEMİ**  
SKYLIGHT SYSTEMS

**SABİT - SABİT**  
FIXED-FIXED

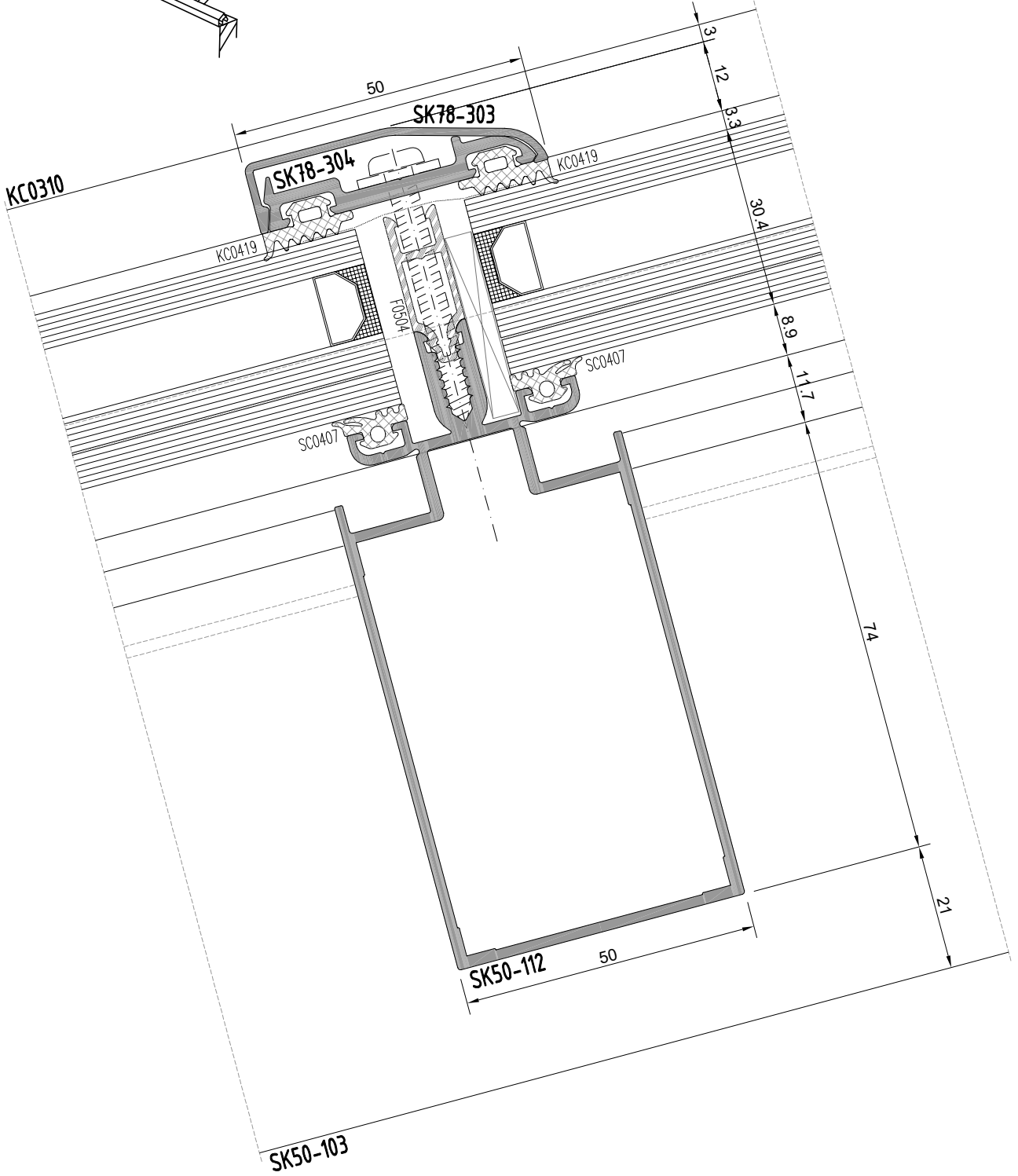
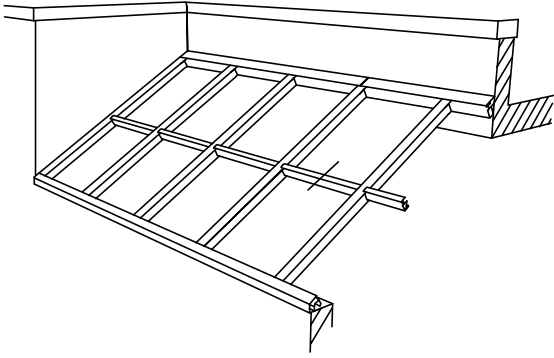

**SKY50**  
**İŞIKLIK SİSTEMİ**  
SKYLIGHT SYSTEMS

**SABİT - SABİT**  
FIXED-FIXED

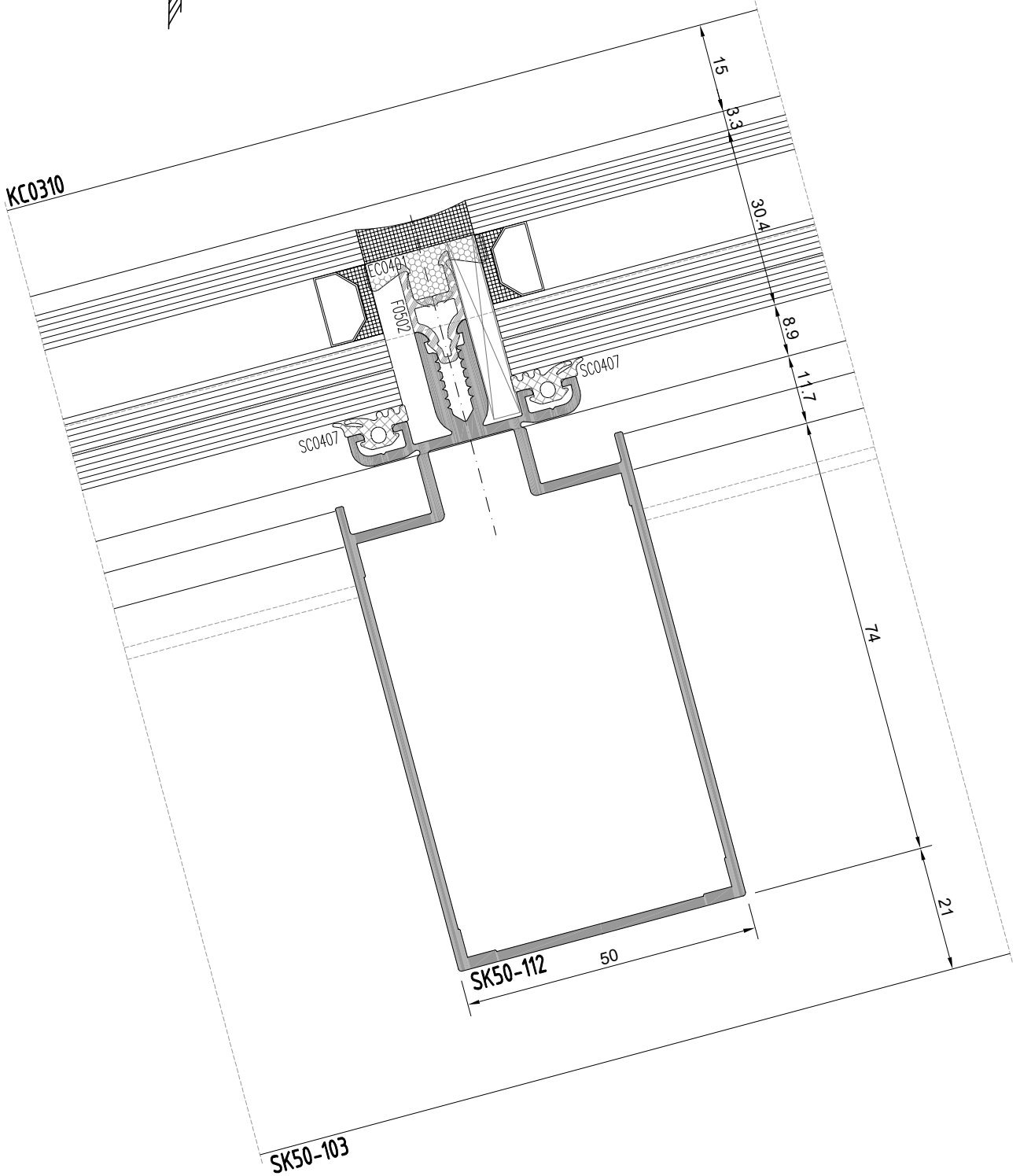
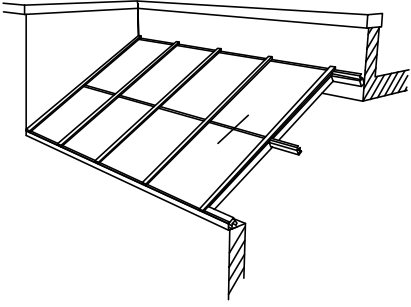



**SKY50**  
**İŞIKLIK SİSTEMİ**  
SKYLIGHT SYSTEMS

**SABİT - KANAT**  
FIXED-SASH

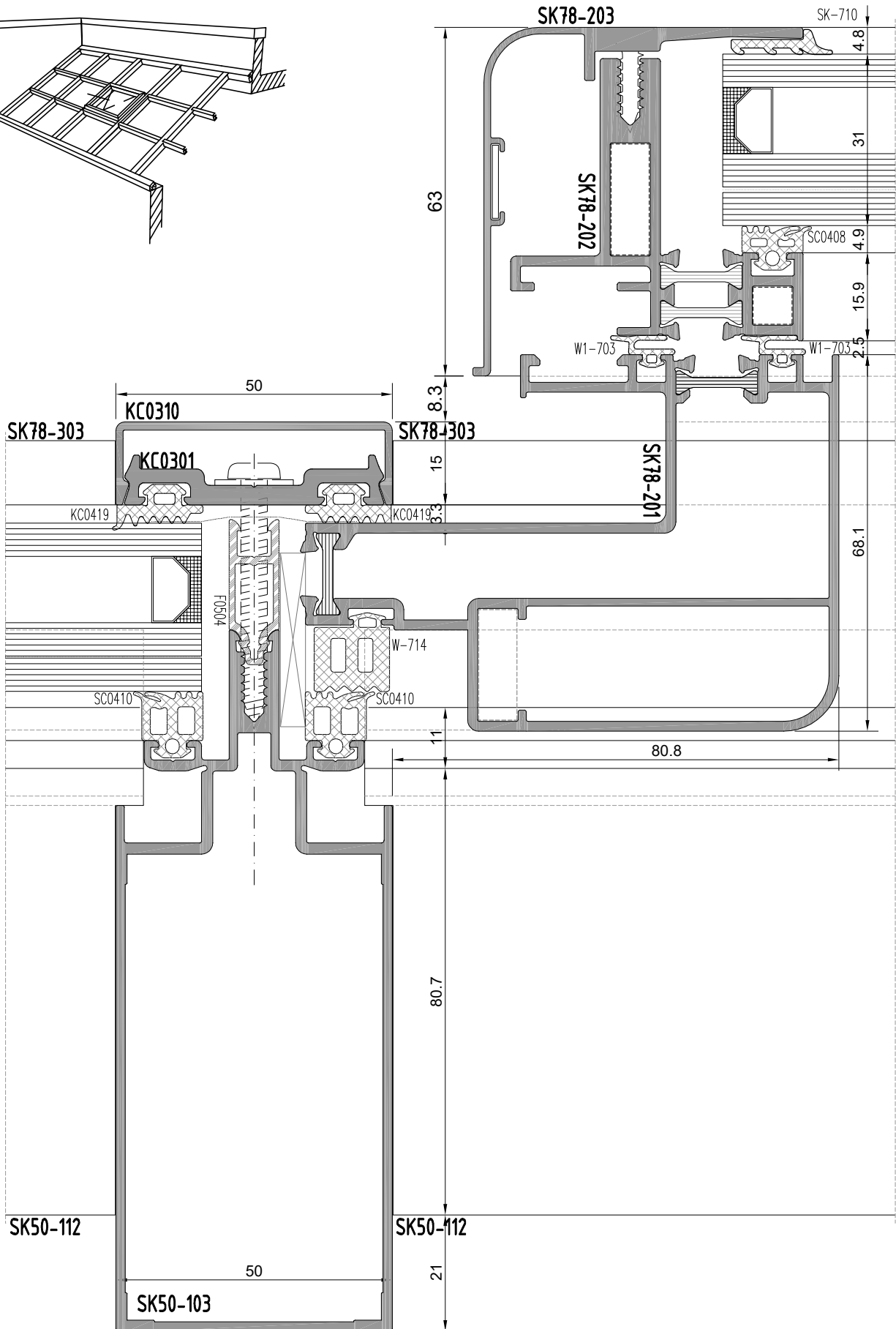
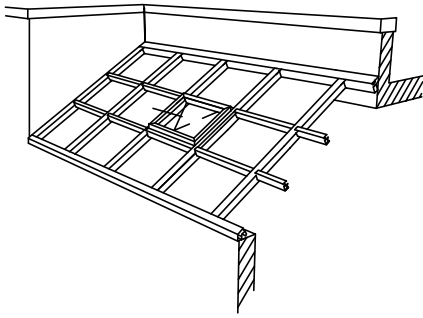

**SKY50**  
**İŞIKLIK SİSTEMİ**  
SKYLIGHT SYSTEMS

**SABİT - KANAT**  
FIXED-SASH

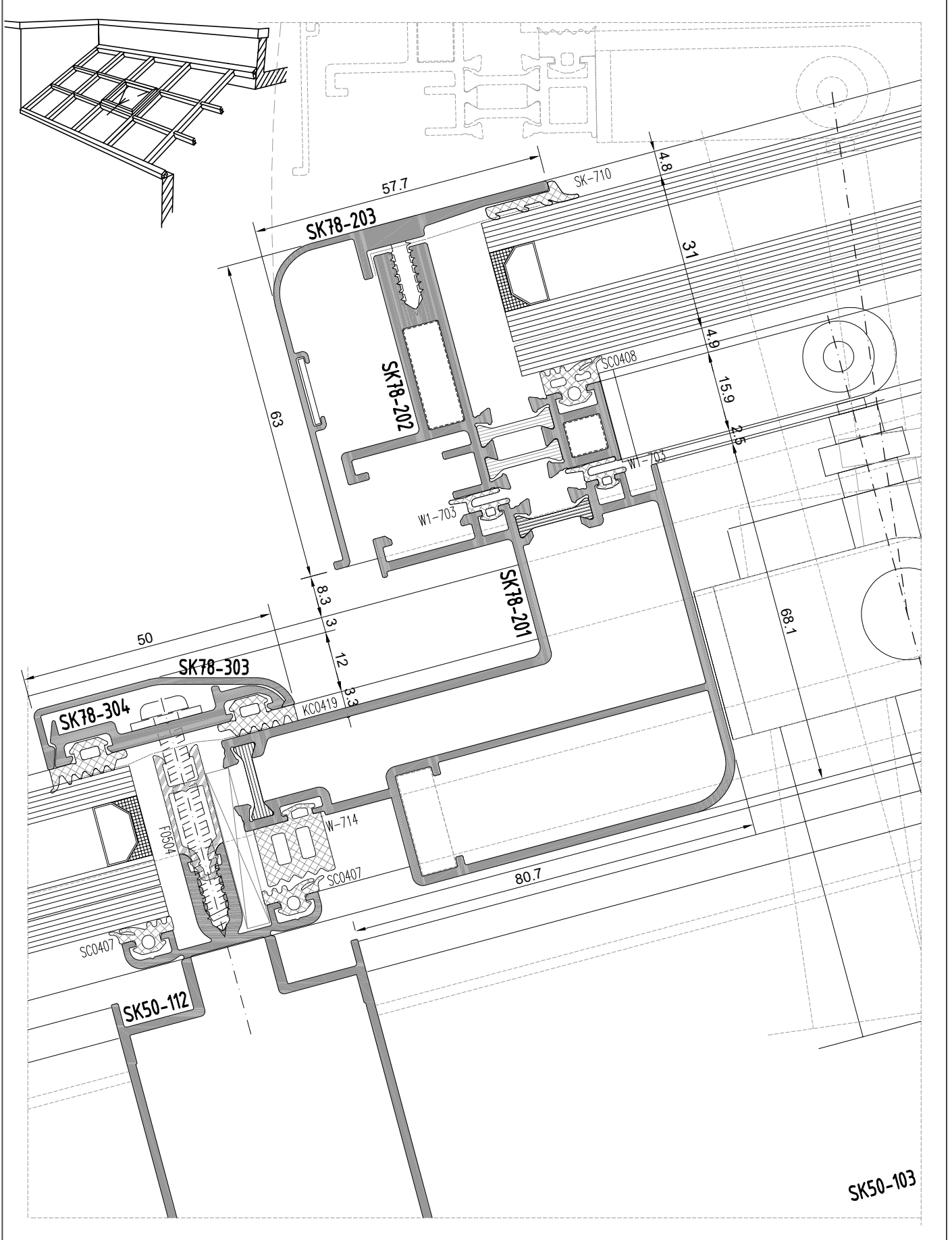

SKY50  
IŞIKLIK SİSTEMİ  
SKYLIGHT SYSTEMS

KANAT - SABİT  
SASH-FIXED

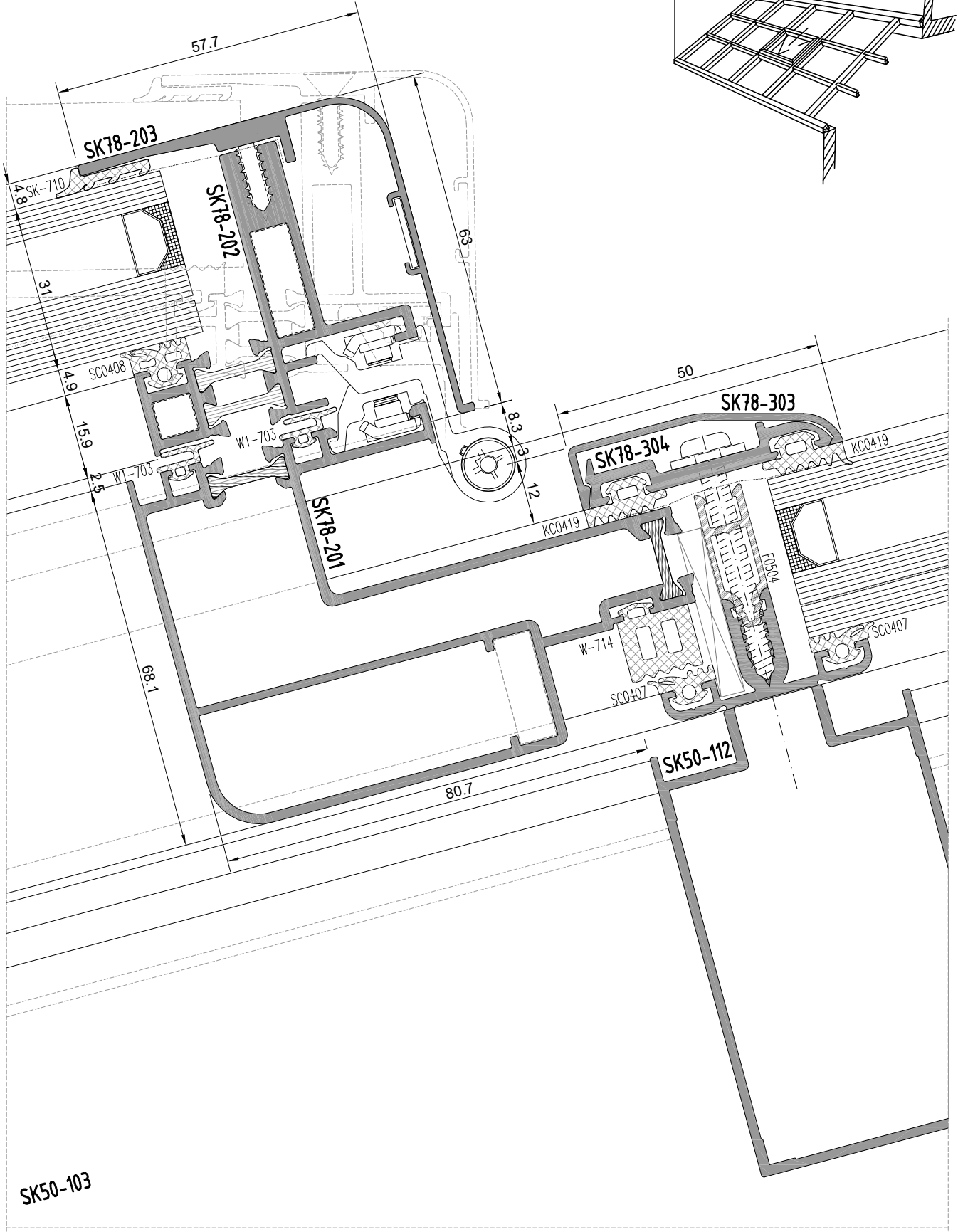
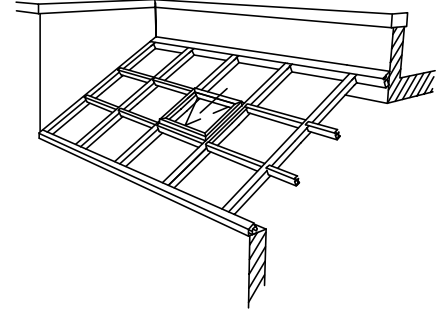

SKY50  
IŞIKLIK SİSTEMİ  
SKYLIGHT SYSTEMS

KÖŞE DETAY  
CORNER DETAIL

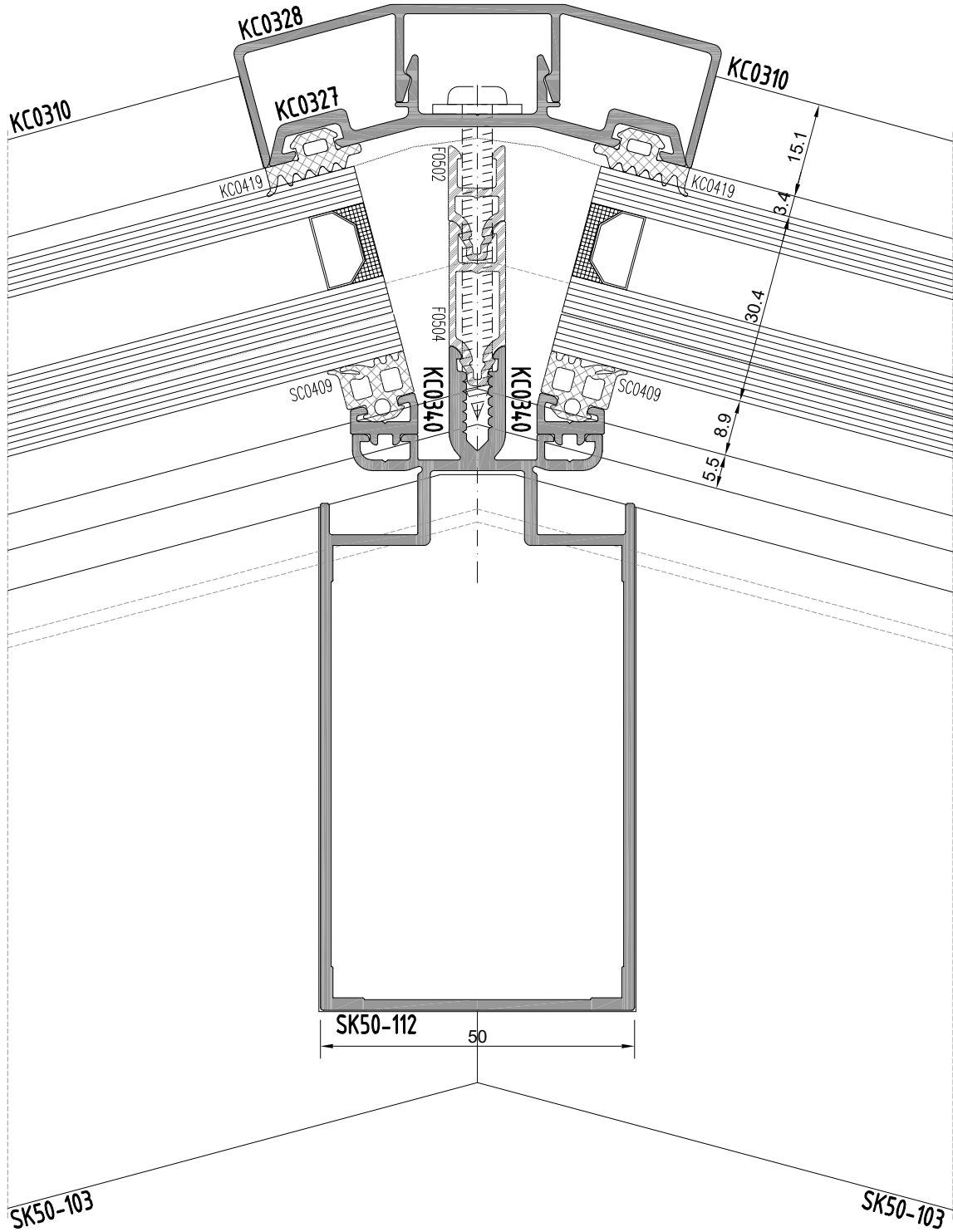
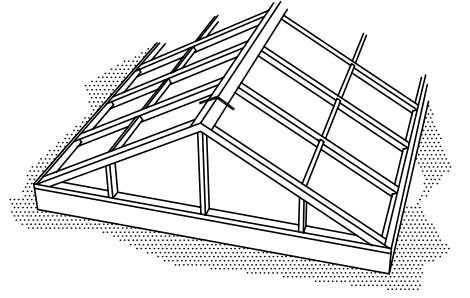

SKY50  
IŞIKLIK SİSTEMİ  
SKYLIGHT SYSTEMS

KÖŞE DETAY  
CORNER DETAIL

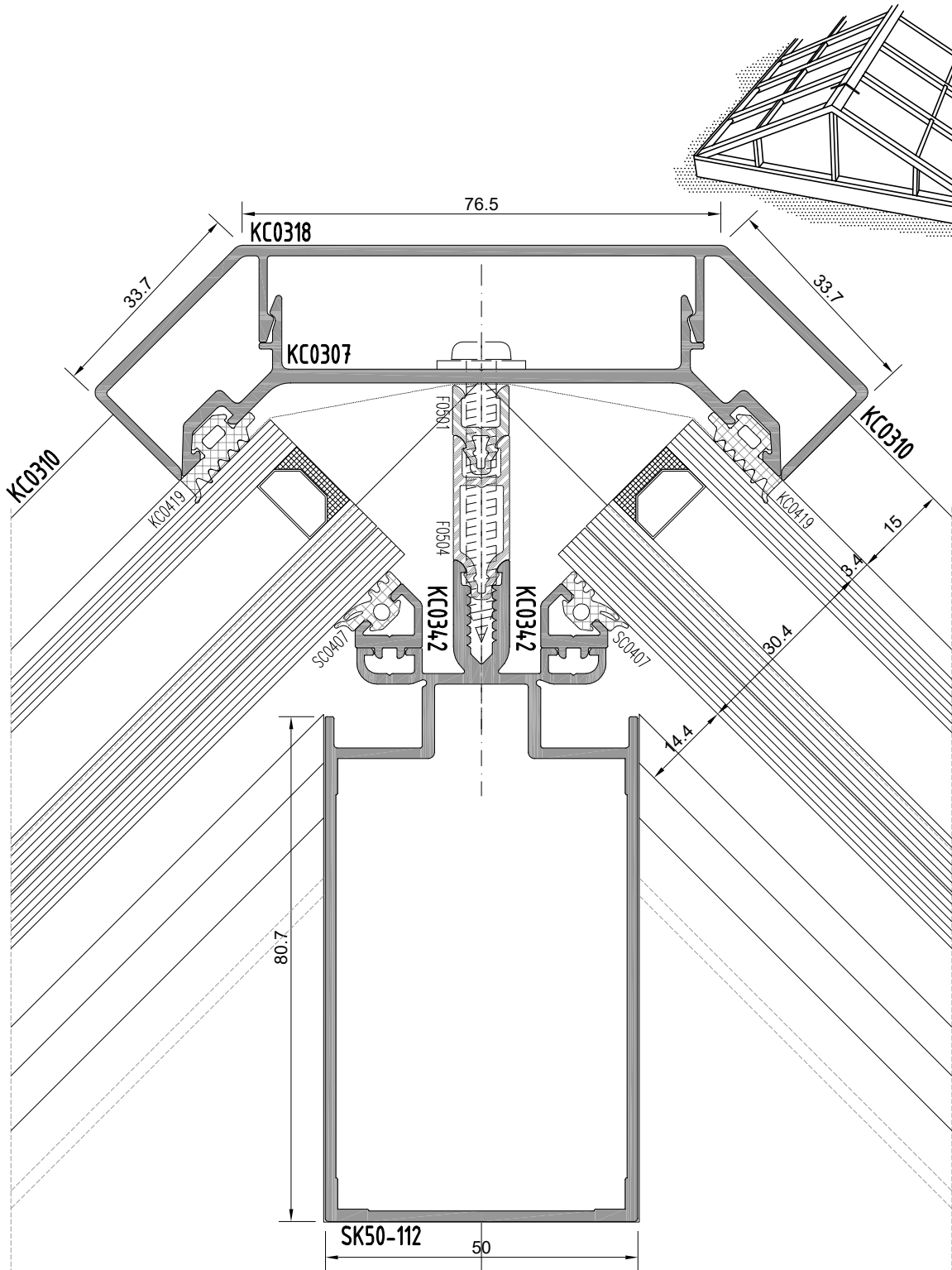

SK50-103

SK50-103

SKY50  
IŞIKLIK SİSTEMİ  
SKYLIGHT SYSTEMS

KÖŞE DETAY  
CORNER DETAIL

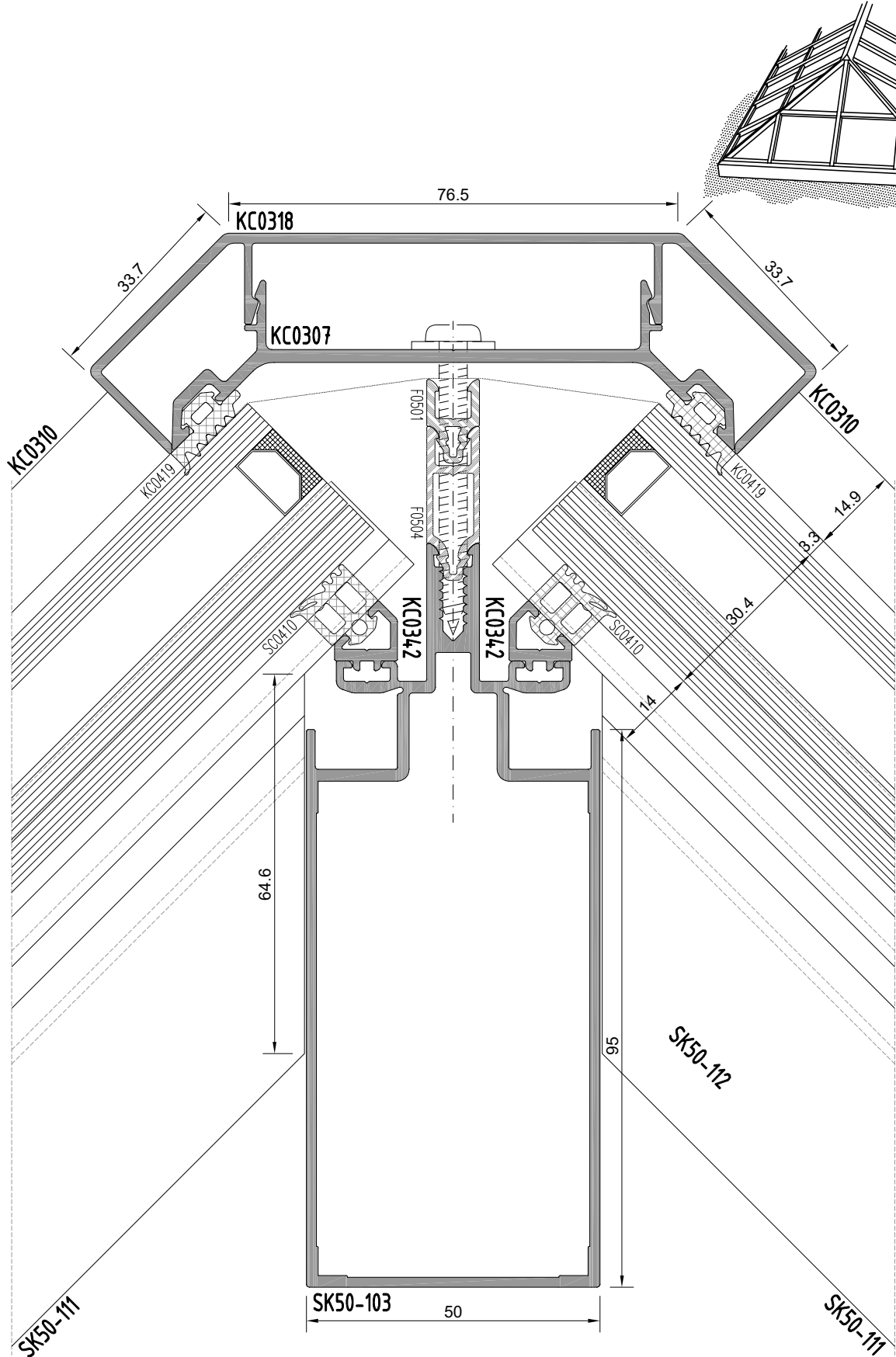

SKY50  
IŞIKLIK SİSTEMİ  
SKYLIGHT SYSTEMS

ALT BİTİM DETAY  
BOTTOM CONNECTION DETAIL

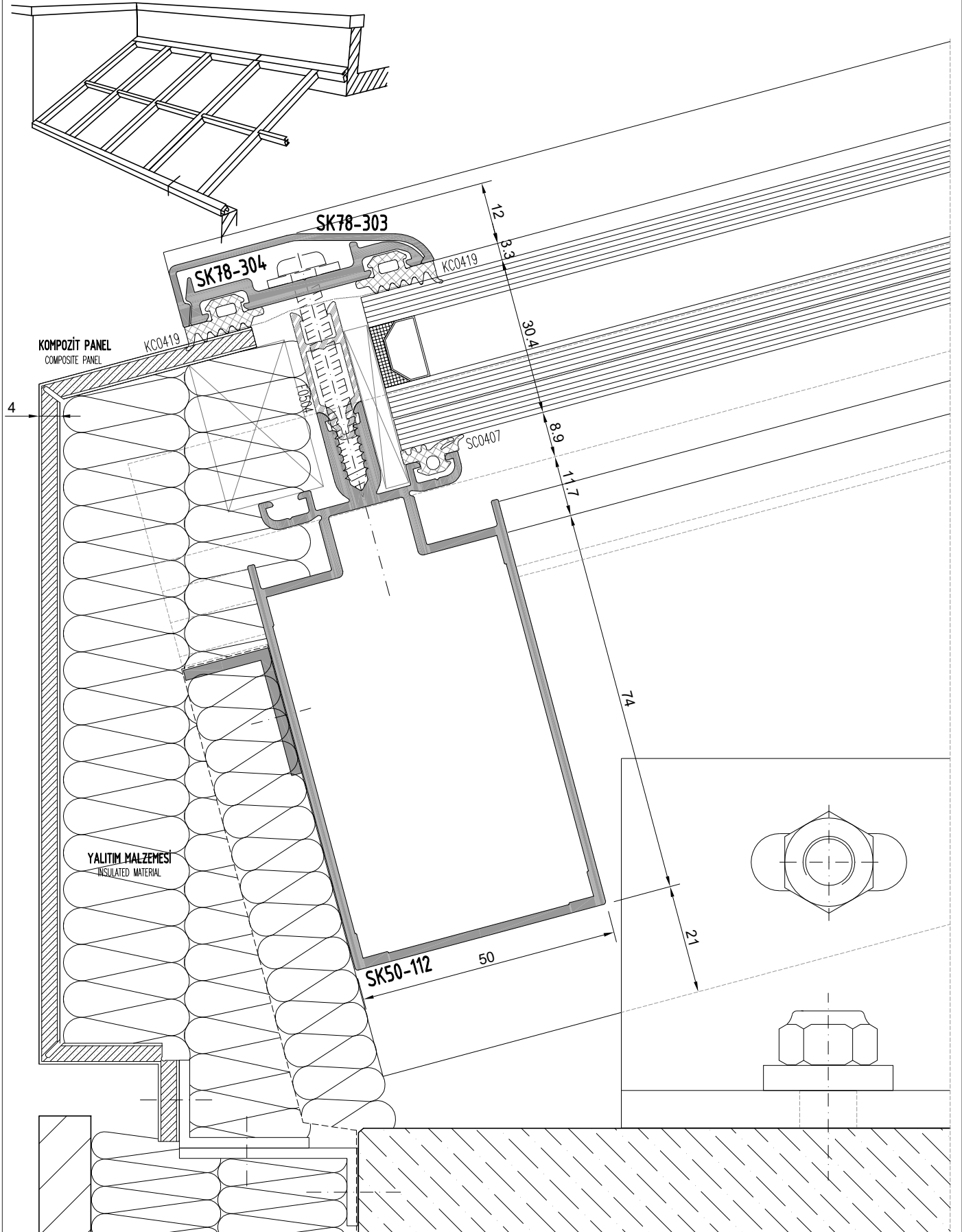

**SKY50**  
**İŞIKLIK SİSTEMİ**  
SKYLIGHT SYSTEMS

**ÜST BİTİM DETAY**  
TOP CONNECTION DETAIL

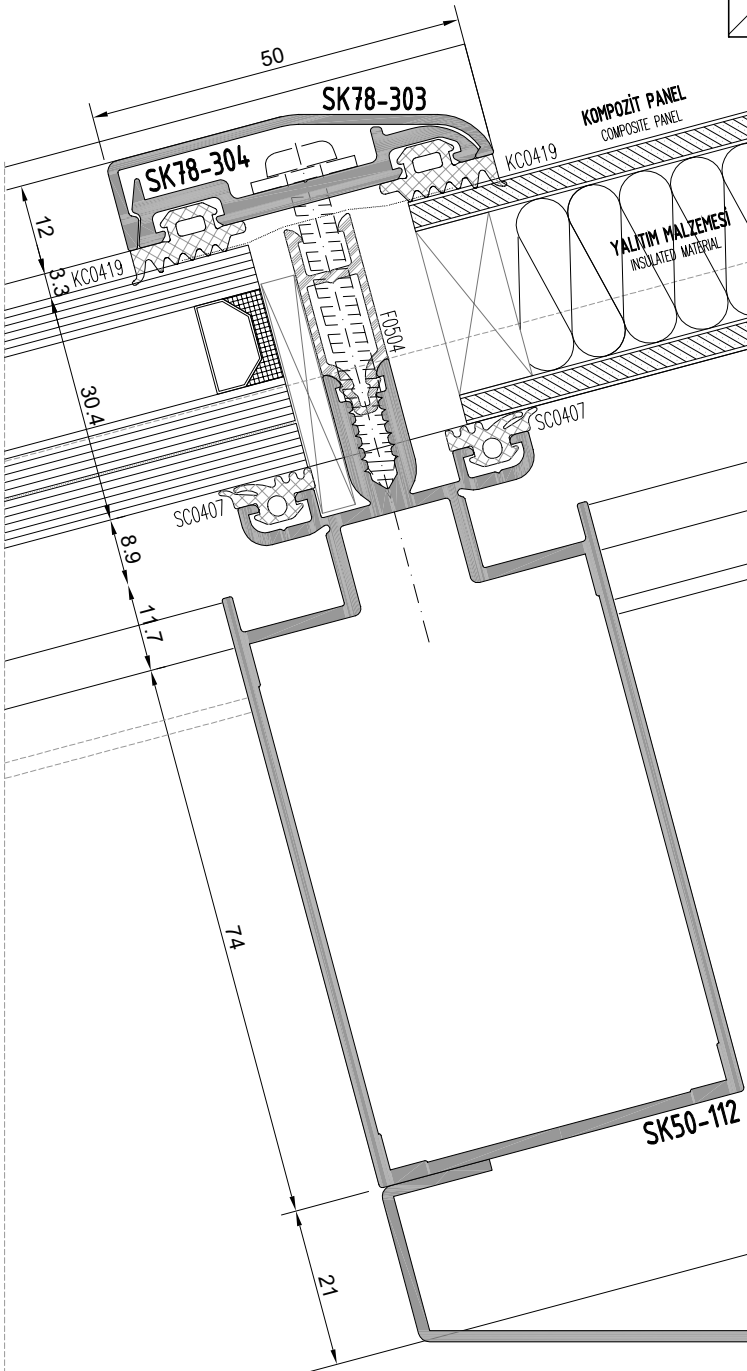
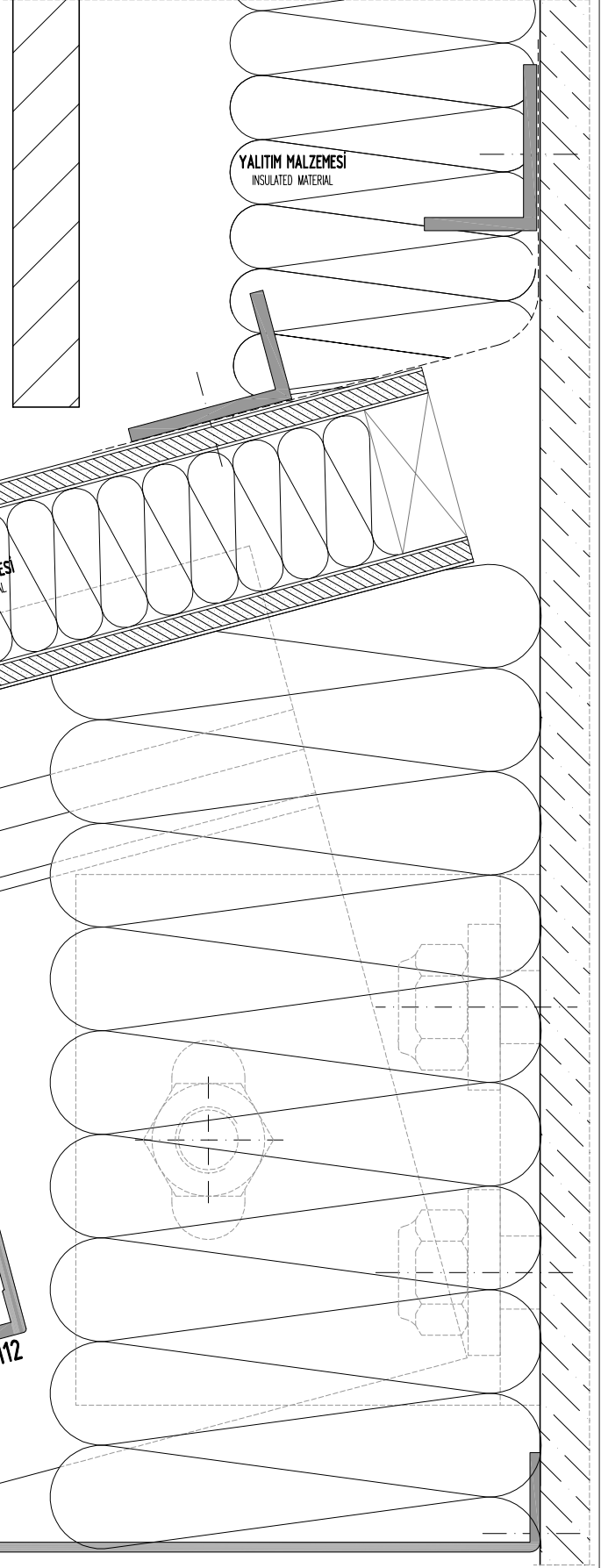
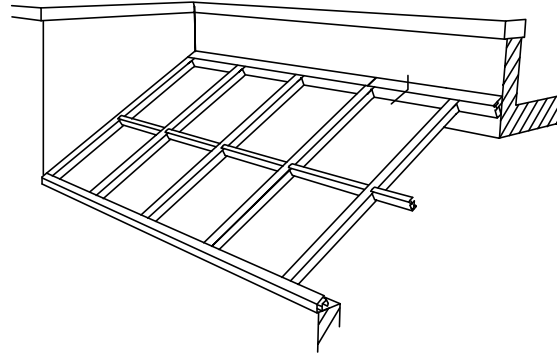



SKY50  
IŞIKLIK SİSTEMİ  
SKYLIGHT SYSTEMS

KÖŞE DETAY  
CORNER DETAIL

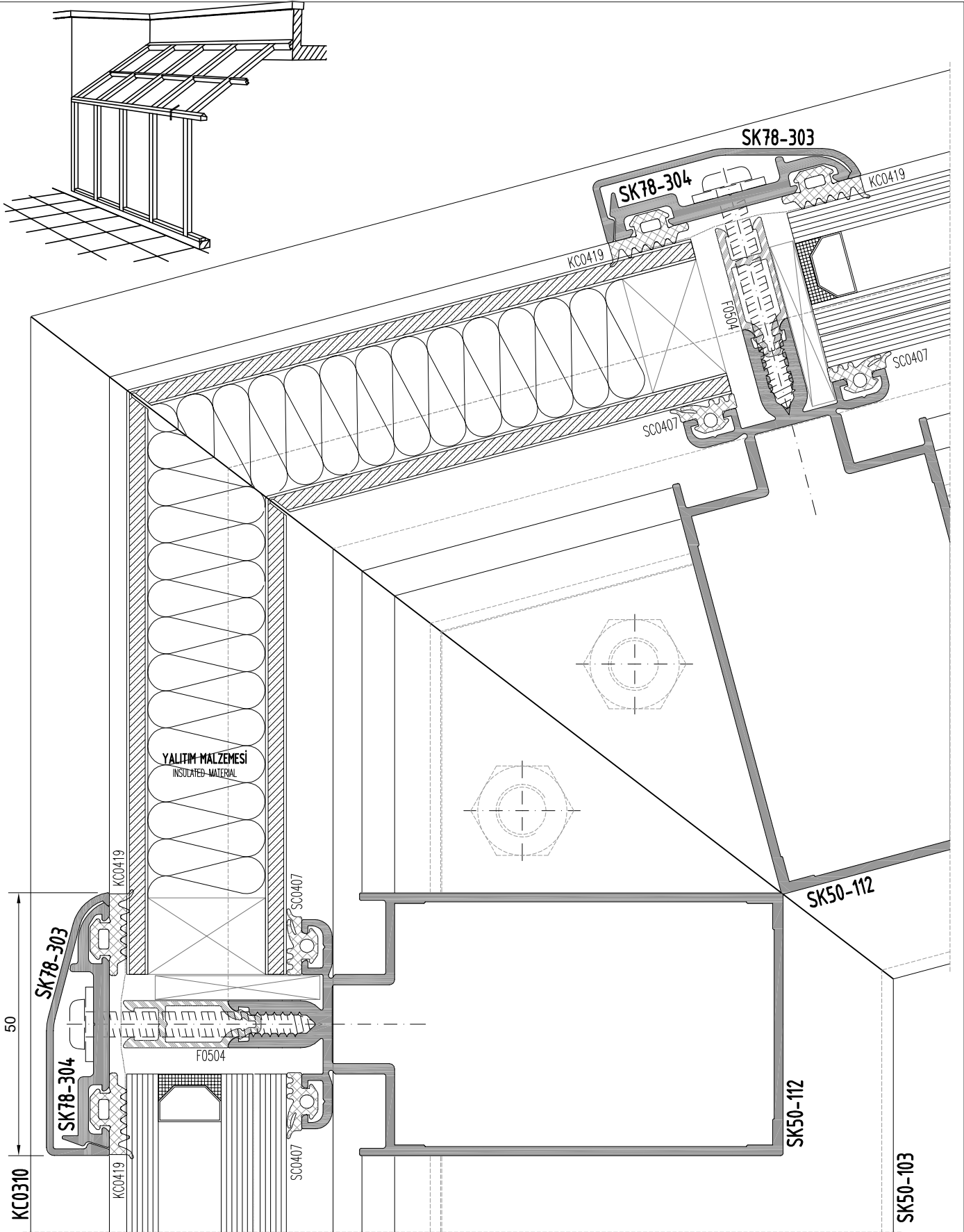

**SKY50**  
**İŞIKLIK SİSTEMİ**  
SKYLIGHT SYSTEMS

**SABİT - SABİT**  
FIXED-FIXED

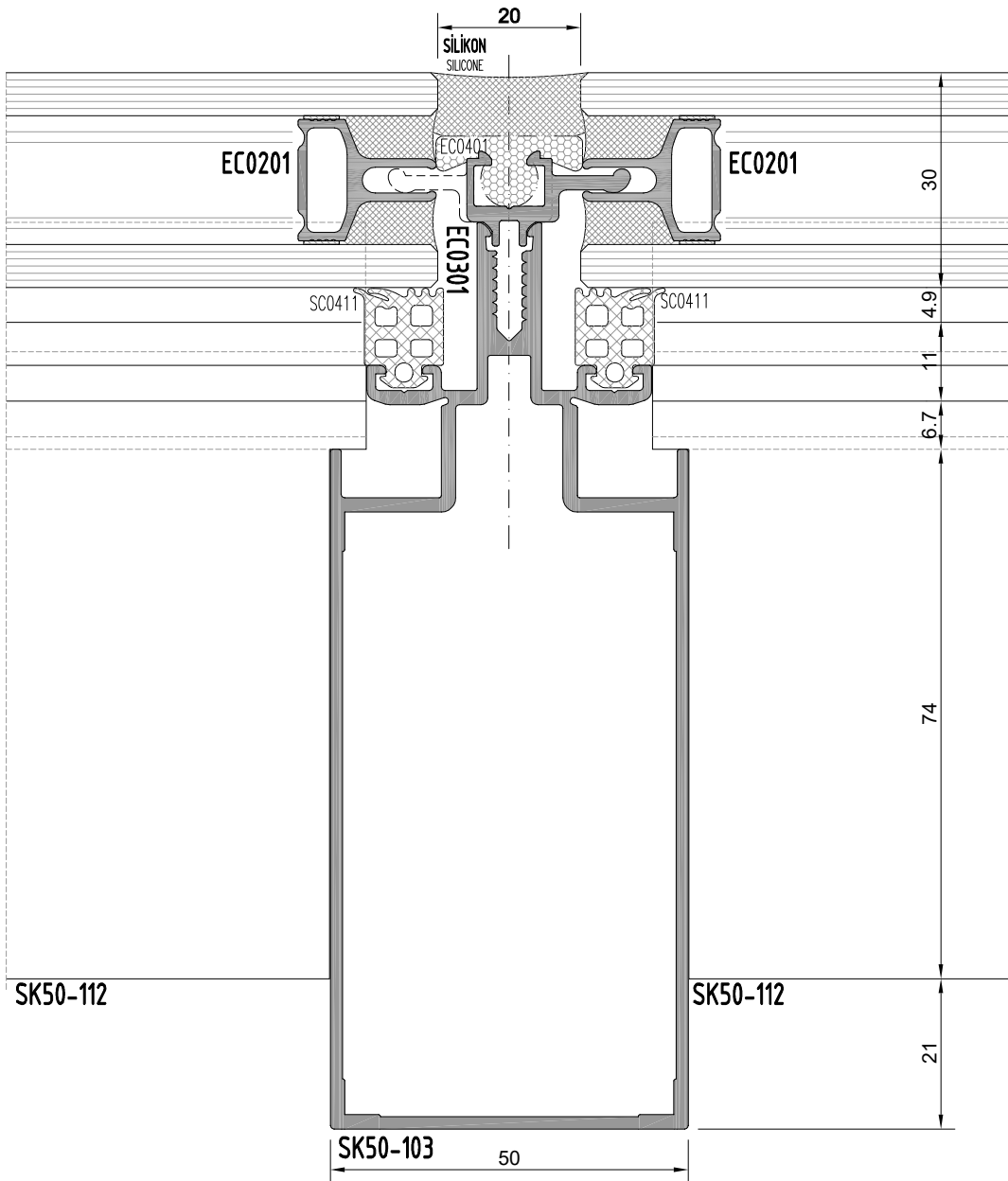
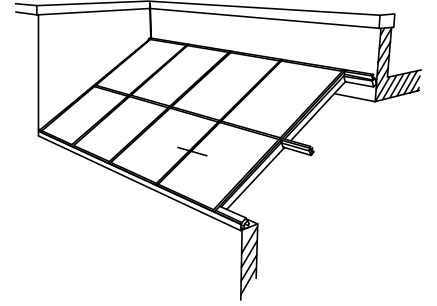

**SKY50**  
**İŞIKLIK SİSTEMİ**  
SKYLIGHT SYSTEMS

**SABİT - SABİT**  
FIXED-FIXED

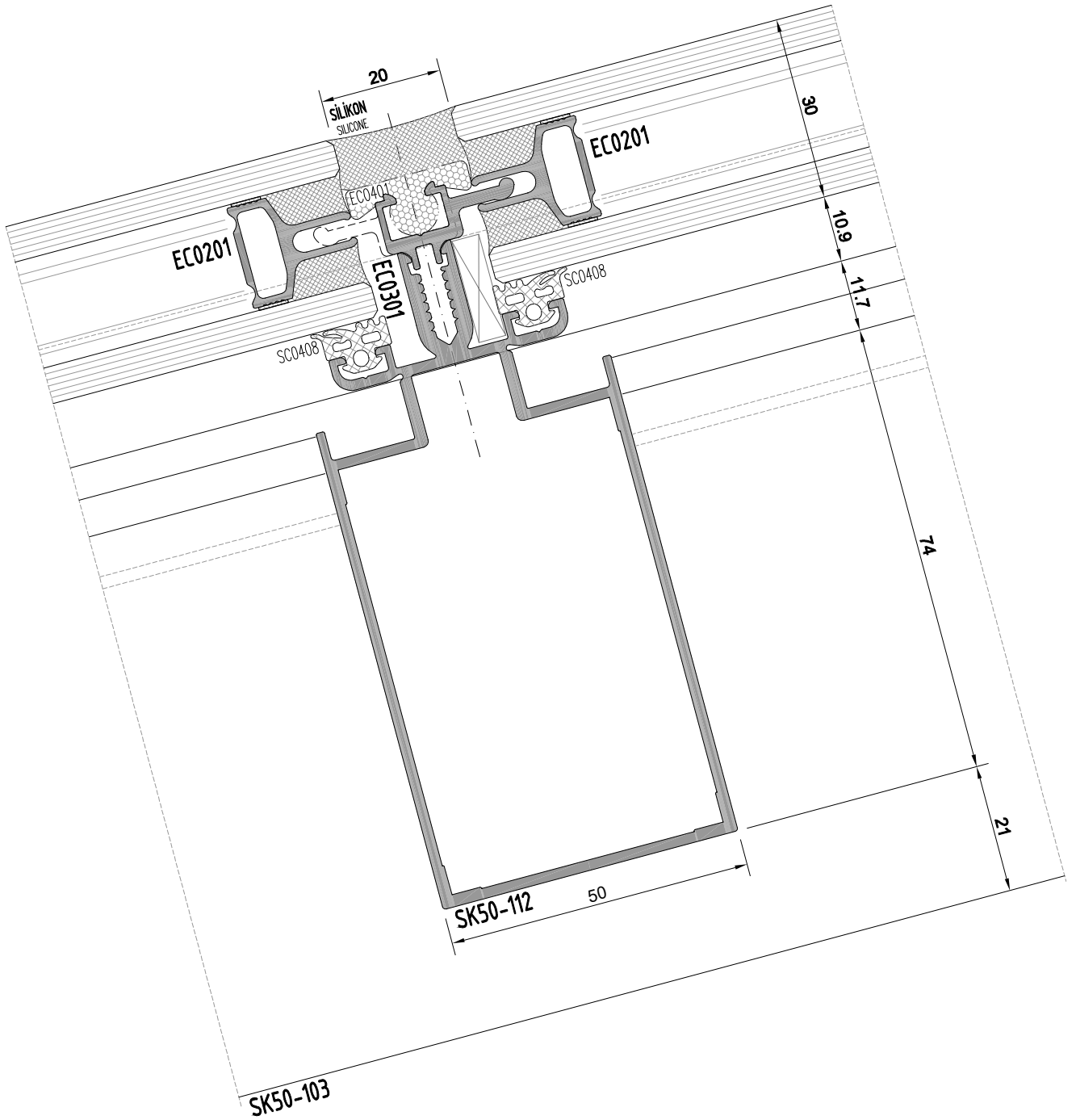
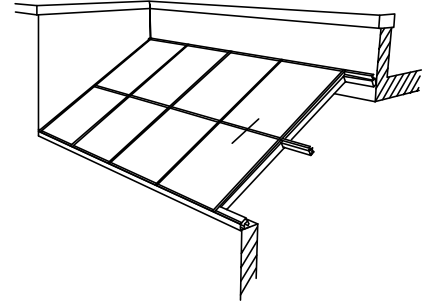

# SKY50

## İŞIKLIK SİSTEMİ

### SKYLIGHT SYSTEMS

**Fıtıl listesi**  
Gasket list

kod code	şekil drawing	tanım description	teorik ağırlık teoretical weight gr / m	paket ağırlığı package weight kg / package	paket metraji in one package metre / package	kullanım yeri aplication
SC0422		Taşıyıcı ve Panel iç fıtılı Mullion-transom or Panel gasket inside	46 gr/m	15 kg	326 m	
SC0407		Taşıyıcı ve Panel iç fıtılı Mullion-transom or Panel gasket inside	73 gr/m	15 kg	205 m	
SC0408		Taşıyıcı ve Panel iç fıtılı Mullion-transom or Panel gasket inside	88 gr/m	15 kg	170 m	
SC0409		Taşıyıcı ve Panel iç fıtılı Mullion-transom or Panel gasket inside	101 gr/m	15 kg	148 m	
SC0410		Taşıyıcı ve Panel iç fıtılı Mullion-transom or Panel gasket inside	113 gr/m	15 kg	133 m	
SC0411		Taşıyıcı ve Panel iç fıtılı Mullion-transom or Panel gasket inside	144 gr/m	15 kg	104 m	
SC0420		Taşıyıcı ve Panel iç fıtılı Mullion-transom or Panel gasket inside	167 gr/m	15 kg	90 m	

# SKY50

## İŞIKLIK SİSTEMİ



### SKYLIGHT SYSTEMS

**Fitil listesi**  
Gasket list

kod code	şekil drawing	tanım description	teorik ağırlık theoretical weight gr / m	paket ağırlığı package weight kg / package	paket metrajı in one package metre / package	kullanım yeri aplication
SC0421		Taşıyıcı ve Panel iç fitili Mullion-transom or Panel gasket inside	189 gr/m		79 m	
SC0425		Taşıyıcı ve Panel iç fitili Mullion-transom or Panel gasket inside	217,6 gr/m	15 kg	69 m	
KC0409		Taşıyıcı ve Panel iç fitili Mullion-transom or Panel gasket inside	249 gr/m	15 kg	60 m	
KC0419		Baskı profil fitili Glazing gasket	73 gr/m	15 kg	205 m	
EC0401		Poliüretan dolgu polyurethane gasket	-	-	205 m	
SK-710		Cam iç fitil Glazing gasket inside	45 gr/m	15 kg	333 m	
W1-703		Kasa fitili Frame gasket	33 gr/m	15 kg	440 m	

**SKY50**  
**İŞIKLIK SİSTEMİ**  
SKYLIGHT SYSTEMS

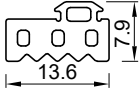
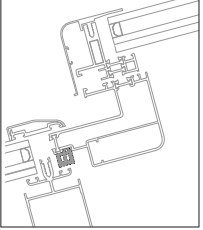
**Fıtıl listesi**  
Gasket list

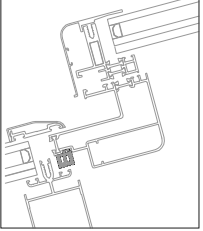
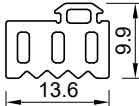
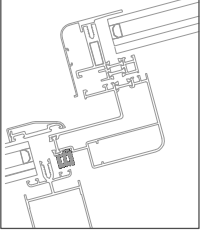
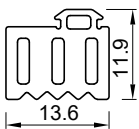
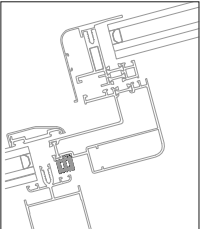
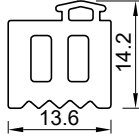
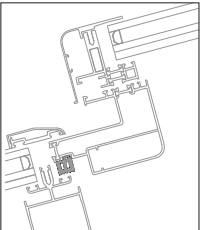
kod code	şekil drawing	tanım description	teorik ağırlık theoretical weight gr / m	paket ağırlığı package weight kg / package	paket metraji in one package metre / package	kullanım yeri aplication
W-708		Profil iç fıtıl Profile gasket inside	91 gr/m	15 kg	165 m	
W-711		Profil iç fıtıl Profile gasket inside	65 gr/m	15 kg	230 m	
W-712		Profil iç fıtıl Profile gasket inside	110 gr/m	15 kg	135 m	
W-713		Profil iç fıtıl Profile gasket inside	135 gr/m	15 kg	110 m	
W-714		Profil iç fıtıl Profile gasket inside	166 gr/m	15 kg	90 m	

**SKY50**  
**İŞIKLIK SİSTEMİ**  
SKYLIGHT SYSTEMS

**Pvc ızalasyon listesi**  
Pvc ızalator list

kod code	şekil drawing	tanım description	metraji metre / package	kullanım yeri aplication
F0500		Taşıyıcı ön ızalasyon (pvc) Mullion or transom front ızalator (pvc)	6 m	
F0501		Taşıyıcı ön ızalasyon (pvc) Mullion or transom front ızalator (pvc)	6 m	
F0502		Taşıyıcı ön ızalasyon (pvc) Mullion or transom front ızalator (pvc)	6 m	
F0503		Taşıyıcı ön ızalasyon (pvc) Mullion or transom front ızalator (pvc)	6 m	
F0504		Taşıyıcı ön ızalasyon (pvc) Mullion or transom front ızalator (pvc)	6 m	
F0505		Taşıyıcı ön ızalasyon (pvc) Mullion or transom front ızalator (pvc)	6 m	
F0506		Taşıyıcı ön ızalasyon (pvc) Mullion or transom front ızalator (pvc)	6 m	

**SKY50**  
**İŞIKLIK SİSTEMİ**  
SKYLIGHT SYSTEMS

**İMALAT ŞEMASI**  
PRODUCTION PLAN

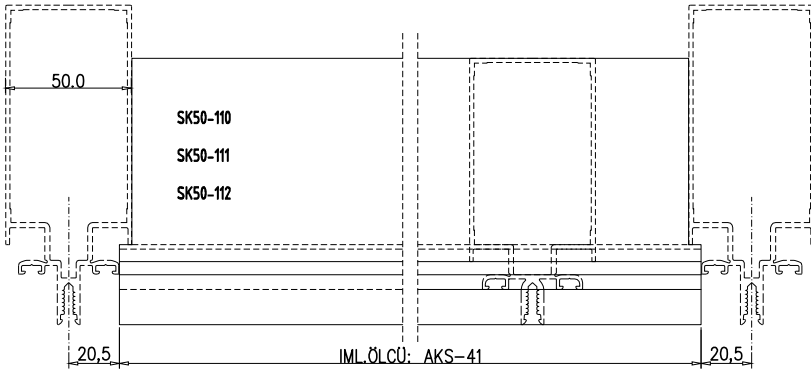
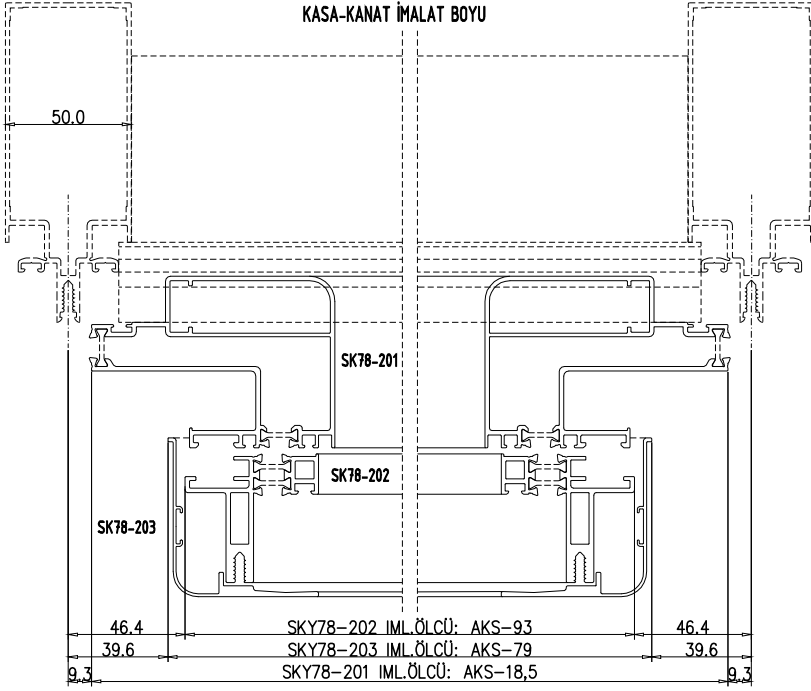

**YATAY TAŞIYICI PROFİL KERTME ve DELİK DELME İŞLEMİ**

