

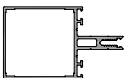

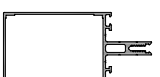



ENTE GRE CEPHE
INTEGRATED FACADE

F50 KLASİK SİSTEM
ENTE GRE CEPHE
F50 CLASSIC SYSTEM
INTEGRATED FACADE

F50 KLASİK SİSTEM
ENTEĞRE CEPHE
F50 CLASSIC SYSTEM
INTEGRATED FACADE

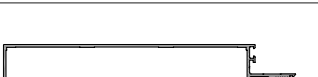
ÜRÜN TEKNİK ÖZELLİKLERİ
PRODUCT'S TECHNICAL FEATURES

No. Nr.	PROFİL KESİTİ PROFILE VIEW	PROFİL NO PROFILE NO	PROFİL AÇIKLAMASI PROFILE DESCRIPTION	BAĞLANTI PARÇALARI CORNER CLEATS	gr/m	STATİK STATIC			
						I_x cm ⁴	I_y cm ⁴	W_x cm ³	W_y cm ³
1		SC0101 (35 - 50) (14 mm)	TAŞIYICI PROFİL MULLION OR TRANSOM PROFILE	SC0310-1 (26.6 mm) SC0301-1 (26.6 mm) SC0302-1 (26.6 mm) SC0316-0 (26.6 mm)	1155	14.17	10.10	4.09	4.04
2		SC0102 (55 - 50) (14 mm)	TAŞIYICI PROFİL MULLION OR TRANSOM PROFILE	SC0310-2 (46.4 mm) SC0301-2 (46.4 mm) SC0302-2 (46.4 mm) SC0316-1 (46.4 mm)	1332	30.95	13.58	7.36	5.43
3		SC0103 (75 - 50) (14 mm)	TAŞIYICI PROFİL MULLION OR TRANSOM PROFILE	SC0310-3 (66.4 mm) SC0301-3 (66.4 mm) SC0302-3 (66.4 mm) SC0316-2 (66.4 mm)	1484	57.03	16.89	10.77	6.76
4		SC0104 (95 - 50) (14 mm)	TAŞIYICI PROFİL MULLION OR TRANSOM PROFILE	SC0310-4 (86.4 mm) SC0301-4 (86.4 mm) SC0302-4 (86.4 mm) SC0316-3 (86.4 mm)	1635	93.67	20.20	14.49	8.08
5		SC0105 (115 - 50) (14 mm)	TAŞIYICI PROFİL MULLION OR TRANSOM PROFILE	SC0310-5 (106 mm) SC0301-5 (106 mm) SC0302-5 (106 mm) SC0316-4 (106 mm)	1838	152.24	23.86	20.58	9.54
6		SC0106 (135 - 50) (14 mm)	TAŞIYICI PROFİL MULLION OR TRANSOM PROFILE	SC0310-6 (126 mm) SC0301-6 (126 mm) SC0302-6 (126 mm) SC0316-5 (126 mm)	2132	223.87	30.40	26.73	12.02
7		SC0107 (155 - 50) (17 mm)	TAŞIYICI PROFİL MULLION OR TRANSOM PROFILE	SC0310-7 (146 mm) SC0301-7 (146 mm) SC0302-7 (146 mm) SC0316-6 (146 mm)	2383	312.21	35.36	33.25	14.14
8		SC0108 (175 - 50) (18 mm)	TAŞIYICI PROFİL MULLION OR TRANSOM PROFILE	SC0310-8 (166 mm) SC0301-8 (166 mm) SC0302-8 (166 mm) SC0316-7 (166 mm)	2658	423.36	41.12	40.77	16.45
9		SC0109 (195 - 50) (18 mm)	TAŞIYICI PROFİL MULLION OR TRANSOM PROFILE	SC0310-9 (186 mm) SC0301-9 (186 mm) SC0302-9 (186 mm) SC0316-8 (186 mm)	3225	615.02	51.02	54.97	20.41
10		SC0110 (35 - 50) (2 mm)	TAŞIYICI PROFİL MULLION OR TRANSOM PROFILE	SC0310-1 (26.6 mm) SC0301-1 (26.6 mm) SC0302-1 (26.6 mm) SC0316-0 (26.6 mm)	1325	15.93	11.84	4.39	4.73









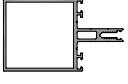
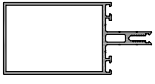

 İşaretili profil için ağırlık etiketinden bilgi alınır.

Profil değerleri teoriktir. Ağırlık olarak testimde yapılan tartım geçerlidir.
Profil imalatları TS EN 12020-2 ve TS EN 755-9 toleransı,
Moment değerleri EN 14024'e göre hesaplanmıştır.

Profile values are theoretical pre-shipment weight will be valid.
The tolerances of Profile manufacturing are calculated according to EN 12020-2
and TS EN 755-9; moment values are calculated according to EN 14024.

F50 KLASİK SİSTEM
ENTEĞRE CEPHE
F50 CLASSIC SYSTEM
INTEGRATED FACADE

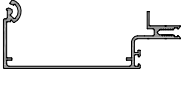
ÜRÜN TEKNİK ÖZELLİKLERİ
PRODUCT'S TECHNICAL FEATURES







No. Nr.	PROFİL KESİTİ PROFILE VIEW	PROFİL NO PROFILE NO	PROFİL AÇIKLAMASI PROFILE DESCRIPTION	BAĞLANTI PARÇALARI CORNER CLEATS	gr/m	STATİK STATIC			
						I_x cm ⁴	I_y cm ⁴	W_x cm ³	W_y cm ³
11		SC0111 (55 - 50) (2 mm)	TAŞIYICI PROFİL MULLION OR TRANSOM PROFILE	SC0310-2 (46.4 mm) SC0301-2 (46.4 mm) SC0302-2 (46.4 mm) SC0316-1 (46.4 mm)	1567	35.63	16.62	8.03	6.65
12		SC0112 (75 - 50) (2 mm)	TAŞIYICI PROFİL MULLION OR TRANSOM PROFILE	SC0310-3 (66.4 mm) SC0301-3 (66.4 mm) SC0302-3 (66.4 mm) SC0316-2 (66.4 mm)	1783	66.57	21.23	12.58	8.49
13		SC0113 (95 - 50) (2 mm)	TAŞIYICI PROFİL MULLION OR TRANSOM PROFILE	SC0310-4 (86.4 mm) SC0301-4 (86.4 mm) SC0302-4 (86.4 mm) SC0316-3 (86.2 mm)	2000	110.45	25.84	17.88	10.34
14		SC0114 (115 - 50) (2 mm)	TAŞIYICI PROFİL MULLION OR TRANSOM PROFILE	SC0310-5 (106 mm) SC0301-5 (106 mm) SC0302-5 (106 mm) SC0316-4 (106 mm)	2267	177.74	30.77	25.55	12.31
15		SC0115 (135 - 50) (2 mm)	TAŞIYICI PROFİL MULLION OR TRANSOM PROFILE	SC0310-6 (126 mm) SC0301-6 (126 mm) SC0302-6 (126 mm) SC0316-5 (126 mm)	2484	255.44	35.39	31.25	14.15
16		SC0116 (155 - 50) (2 mm)	TAŞIYICI PROFİL MULLION OR TRANSOM PROFILE	SC0310-7 (146 mm) SC0301-7 (146 mm) SC0302-7 (146 mm) SC0316-6 (146 mm)	2700	315.36	39.99	38.30	16.00
17		SC0117 (175 - 50) (2 mm)	TAŞIYICI PROFİL MULLION OR TRANSOM PROFILE	SC0310-8 (166 mm) SC0301-8 (166 mm) SC0302-8 (166 mm) SC0316-7 (166 mm)	2917	467.15	44.60	45.71	17.84
18	  İşaretili profil için satış ekibinden bilgi alınır.	SC0121-A (95 - 44) (15 mm)	TAŞIYICI PROFİL MULLION PROFILE		1262	92.06	7.97	14.77	2.80
19	  İşaretili profil için satış ekibinden bilgi alınır.	SC0121-B (95 - 48) (15 mm)	TAŞIYICI PROFİL MULLION PROFILE		1351	100.05	9.84	15.23	3.25
20		SC0122-A (115 - 44) (15 mm)	TAŞIYICI PROFİL MULLION PROFILE		1344	135.18	8.61	18.89	2.92

Profil değerleri teoriktir. Ağırlık olarak testimde yapılan tartım geçerlidir.
Profil imalatları TS EN 12020-2 ve TS EN 755-9 toleransları,
Moment değerleri EN 14024'e göre hesaplanmıştır.

Profile values are theoretical pre-shipment weight will be valid.
The tolerances of Profile manufacturing are calculated according to EN 12020-2
and TS EN 755-9; moment values are calculated according to EN 14024.

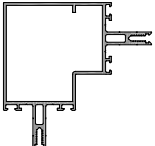
F50 KLASİK SİSTEM
ENTEĞRE CEPHE
F50 CLASSIC SYSTEM
INTEGRATED FACADE

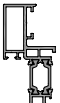
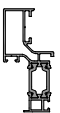
ÜRÜN TEKNİK ÖZELLİKLERİ
PRODUCT'S TECHNICAL FEATURES









No. Nr.	PROFİL KESİTİ PROFILE VIEW	PROFİL NO PROFILE NO	PROFİL AÇIKLAMASI PROFILE DESCRIPTION	BAĞLANTI PARÇALARI CORNER CLEATS	gr/m	STATİK STATIC			
						Ix cm ⁴	Iy cm ⁴	Wx cm ³	Wy cm ³
21		SC0122-B (115 - 48) (15 mm)	TAŞIYICI PROFİL MULLION PROFILE		1432	147.01	10.62	19.55	3.40
22		SC0124-A (155 - 44.3) (18 mm)	TAŞIYICI PROFİL MULLION PROFILE		1645	265.39	10.62	28.92	3.37
23		SC0124-B (155 - 47) (18 mm)	TAŞIYICI PROFİL MULLION PROFILE		1785	297.01	13.56	30.26	4.20
24		SC0127 (75 - 75) (14 mm)	TAŞIYICI PROFİL MULLION PROFILE	SC0316-2 (66.4 mm)	2579				
25		SC0201 (34.9 - 49.5) (13 mm)	ÇİFT CAM PANEL PROFİLİ PANEL PROFILE FOR DOUBLE GLASS	SC0308-a (25,68 mm) SC0307-a (10,25 mm) SC0304-a (50 mm)	734				
26		SC0210 (36.1 - 50.5) (2 mm)	ÇİFT CAM PANEL PROFİLİ PANEL PROFILE FOR DOUBLE GLASS	SC0308-a (25,68 mm) SC0307-a (10,25 mm) SC0304-a (50 mm)	1001				
27		SC0215 (33.2 - 73.1) (2 mm)	ÇİFT CAM PANEL PROFİLİ PANEL PROFILE FOR DOUBLE GLASS	SC0308-b (29,74 mm) SC0309-a (6,5 mm) SC0304-a (50 mm)	PVC 1365 POLYAMİD 1350				
28		SC0216 (32 - 71.6) (13 mm)	TEK CAM PANEL PROFİLİ PANEL PROFILE FOR SINGLE GLASS	SC0308-b (29,74 mm) SC0309-a (6,5 mm) SC0304-a (50 mm)	PVC 1060 POLYAMİD 1045				
29		SC0218 (33.5 - 64.5) (13 mm)	ÇİFT CAM PANEL PROFİLİ PANEL PROFILE FOR DOUBLE GLASS	SC0308-b (29,74 mm) SC0308-g (19,5 mm) SC0304-a (50 mm)	1241				
30		SC0301 (6.2 - 35.3) (5 mm)	KIRLANGIÇ GEÇME PROFİLİ T-CONNECTOR FOR TRANSOM PROFILE		470				

Profil değerleri teoriktir. Ağırlık olarak testimde yapılan tartım geçerlidir.
Profil imalatları TS EN 12020-2 ve TS EN 755-9 toleransları,
Moment değerleri EN 14024'e göre hesaplanmıştır.

Profile values are theoretical pre-shipment weight will be valid.
The tolerances of Profile manufacturing are calculated according to EN 12020-2
and TS EN 755-9; moment values are calculated according to EN 14024.

F50 KLASİK SİSTEM
ENTEĞRE CEPHE
F50 CLASSIC SYSTEM
INTEGRATED FACADE

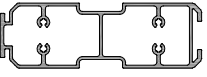
ÜRÜN TEKNİK ÖZELLİKLERİ
PRODUCT'S TECHNICAL FEATURES







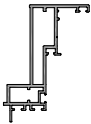

No. Nr.	PROFİL KESİTİ PROFILE VIEW	PROFİL NO PROFILE NO	PROFİL AÇIKLAMASI PROFILE DESCRIPTION	BAĞLANTI PARÇALARI CORNER CLEATS	gr/m	STATİK STATIC			
						Ix cm ⁴	Iy cm ⁴	Wx cm ³	Wy cm ³
31		SC0302 (29,8 - 45,7) (2 mm)	KIRLANGIÇ GEÇME PROFİLİ T-CONNECTOR FOR TRANSOM PROFILE		1002				
32		SC0303 (4,4 - 19,5) (15 mm)	TİJ PROFİLİ PUSHING ROD PROFILE		96				
33		SC0307 (55 - 55) (9,71 mm)	KÖŞE BİRLEŞTİRME PROFİLİ CORNER CLEATS PROFILE		1737				
34		SC0308 (55 - 55) (11,82 mm)	KÖŞE BİRLEŞTİRME PROFİLİ CORNER CLEATS PROFILE		2313				
35		SC0309 (55 - 55) (6,9 mm)	KÖŞE BİRLEŞTİRME PROFİLİ CORNER CLEATS PROFILE		1573				
36		SC0310 (31,2 - 45,7) (2,2 mm)	KLASİK TAŞIYICI BAĞ. PR. T-CONNECTOR FOR TRANSOM PROFILE		821				
37		SC0312 (25,1 - 4,2) (2 mm)	CAM OTURTMA PROFİLİ GLAZING SUPPORT FOR SASH PROFILE		147				
38		SC0316 (14,0 - 45,7) (1,9 mm)	DİLATASYON PROFİLİ DILATATION PROFILE		3079				
39		SC0350 (23,2 - 6,7) (1,2 mm)	CAM OTURTMA PROFİLİ GLAZING SUPPORT FOR SASH PROFILE		140				
40		KC0201 (54,6 - 59) (1,3 mm)	SAKLI KANAT KASA PR. OUTER FRAME PROFILE	SC0307-b (27 mm) SC0309-b (8,55 mm)	737				

Profil değerleri teoriktir. Ağırlık olarak testimde yapılan tartım geçerlidir.
Profil imalatları TS EN 12020-2 ve TS EN 755-9 toleransı,
Moment değerleri EN 14024'e göre hesaplanmıştır.

Profile values are theoretical pre-shipment weight will be valid.
The tolerances of Profile manufacturing are calculated according to EN 12020-2
and TS EN 755-9; moment values are calculated according to EN 14024.

F50 KLASİK SİSTEM
ENTEĞRE CEPHE
F50 CLASSIC SYSTEM
INTEGRATED FACADE

ÜRÜN TEKNİK ÖZELLİKLERİ
PRODUCT'S TECHNICAL FEATURES

No. Nr.	PROFİL KESİTİ PROFILE VIEW	PROFİL NO PROFILE NO	PROFİL AÇIKLAMASI PROFILE DESCRIPTION	BAĞLANTI PARÇALARI CORNER CLEATS	gr/m	STATİK STATIC			
						Ix cm ⁴	Iy cm ⁴	Wx cm ³	Wy cm ³
41		KC0202 (53.2 - 70.6) (13 mm)	SAKLI KANAT KASA PR. OUTER FRAME PROFILE	SC0309-c (18,9 mm)	792				
42		KC0204 (59.5 - 81.3) (2,0 mm)	SAKLI KANAT KASA PR. OUTER FRAME PROFILE	SC0308-h (9,9 mm) SC0309-j (52,8 mm)	1463				
43		KC0303 (61 - 47.2) (15 mm)	KÖŞE BAĞLANTI PROFİLİ CORNER CONNECTION PROFILE		1463				
44		KC0308 (38.4 - 10.1) (2 mm)	TIRNAK ADAPTÖR PR. CLAW ADAPTER PROFILE		329				
45		KC0331 (20 - 11) (12 mm)	TEK CAM ADAPTÖRÜ PR. SINGLE GLAZING ADAPTER PROFILE		207				
46		KC0332 (22 - 11) (12 mm)	TEK CAM ADAPTÖRÜ PR. SINGLE GLAZING ADAPTER PROFILE		218				
47		KC0333 (16 - 11) (12 mm)	TEK CAM ADAPTÖRÜ PR. SINGLE GLAZING ADAPTER PROFILE		179				
48		KC0334 (18 - 11) (12 mm)	TEK CAM ADAPTÖRÜ PR. SINGLE GLAZING ADAPTER PROFILE		192				
49		KC0340 (10.7 - 8.3) (12 mm)	15° - ADAPTÖR PROFİLİ 15°-ADAPTER PROFILE		98				
50		KC0341 (10.7 - 10.3) (12 mm)	30° - ADAPTÖR PROFİLİ 30°-ADAPTER PROFILE		105				

Profil değerleri teoriktir. Ağırlık olarak testimde yapılan tartım geçerlidir.
Profil imalatları TS EN 12020-2 ve TS EN 755-9 toleransı,
Moment değerleri EN 14024'e göre hesaplanmıştır.

Profile values are theoretical pre-shipment weight will be valid.
The tolerances of Profile manufacturing are calculated according to EN 12020-2
and TS EN 755-9; moment values are calculated according to EN 14024.

F50 KLASİK SİSTEM
ENTEĞRE CEPHE
F50 CLASSIC SYSTEM
INTEGRATED FACADE

ÜRÜN TEKNİK ÖZELLİKLERİ
PRODUCT'S TECHNICAL FEATURES

No. Nr.	PROFİL KESİTİ PROFILE VIEW	PROFİL NO PROFILE NO	PROFİL AÇIKLAMASI PROFILE DESCRIPTION	BAĞLANTI PARÇALARI CORNER CLEATS	gr/m	STATİK STATIC			
						Ix cm ⁴	Iy cm ⁴	Wx cm ³	Wy cm ³
51		KC0342 (10.7 - 11.9) (12 mm)	45° - ADAPTÖR PROFİLİ 45°-ADAPTER PROFILE		112				
52		KC0343 (10.7 - 13.6)	60° - ADAPTÖR PROFİLİ 60°-ADAPTER PROFILE		123				
53		KC0350 (6 - 11) (1 mm)	TEK CAM ADAPTÖRÜ PR. SINGLE GLAZING ADAPTER PROFILE		96				
54		KC0351 (14 - 11) (12 mm)	TEK CAM ADAPTÖRÜ PR. SINGLE GLAZING ADAPTER PROFILE		151				
55	 	KC0352 (35 - 50) (17 mm)	TEK CAM ADAPTÖRÜ PR. SINGLE GLAZING ADAPTER PROFILE		270				
56		EC0201 (19.3 - 17) (12 mm)	ÇİFT CAM İÇİ PANEL PR. PANEL PROFILE FOR DOUBLE GLASS		220				
57		EC0202 (18 - 32) (12 mm)	TEK CAM Panel PROFİL PANEL PROFILE FOR SINGLE GLASS	SC0308-c (24,36 mm) EC0301-a (50 mm)	323				
58		EC0203 (18 - 32) (12 mm)	KOMPOZİT PANEL PROFİL PANEL PROFILE FOR COMPOSITE	SC0308-c (24,36 mm) EC0301-a (50 mm)	353				
59		EC0301 (22.1 - 10.7) (12 mm)	BAĞLANTI PROFİLİ CONNECTION PROFILE	EC0303 (PVC) EC0301-a (50 mm)	223				
60		EC0302 (48.8 - 9.4) (2 mm)	CAM ALTI TAKOZ PR. GLASS SUPPORT PIECE PROFILE		419				
61		SC0346 (8.9 - 31.3) (1 mm)	TAŞIYICI DİLATASYON PR. DILATATION PLASTIC PR. FOR MULLION		120				

Profil değerleri teoriktir. Ağırlık olarak testimde yapılan tartım geçerlidir.
Profil imalatları TS EN 12020-2 ve TS EN 755-9 toleransı,
Moment değerleri EN 14024'e göre hesaplanmıştır.

Profile values are theoretical pre-shipment weight will be valid.
The tolerances of Profile manufacturing are calculated according to EN 12020-2
and TS EN 755-9; moment values are calculated according to EN 14024.

F50 KLASİK SİSTEM ENTEĞRE CEPHE PROFİLLERİ

F50 CLASSIC SYSTEM
INTEGRATED FACADE PROFILE

ÜRÜN TEKNİK ÖZELLİKLERİ
PRODUCT'S TECHNICAL FEATURES

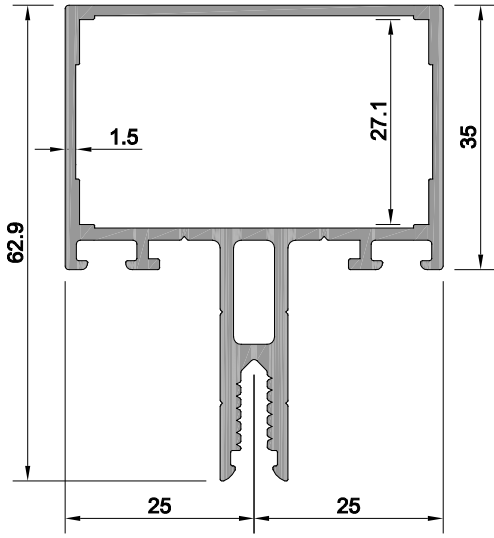

Profil No: SC0101

Ağırlık : 1155 gr/m

I_x : 14,17 cm^4

I_y : 10,10 cm^4

w_x : 4,09 cm^3

w_y : 4,04 cm^3



SC0310-1



SC0301-1



SC0302-1



SC0316-0

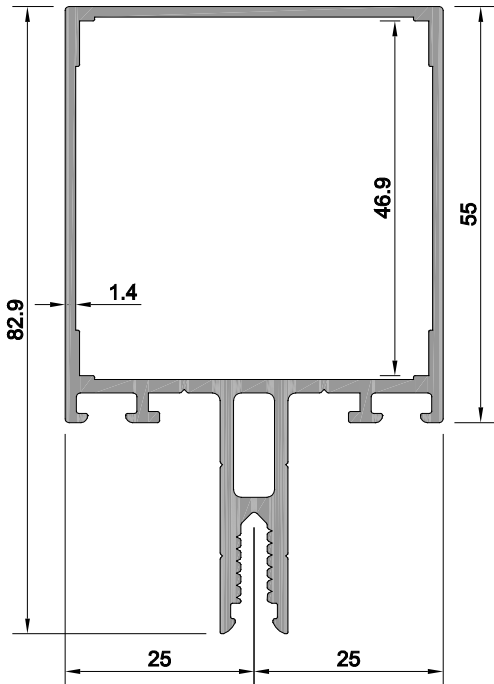

Profil No: SC0102

Ağırlık : 1332 gr/m

I_x : 30,95 cm^4

I_y : 13,58 cm^4

w_x : 7,36 cm^3

w_y : 5,43 cm^3



SC0310-2



SC0301-2



SC0302-2



SC0316-1

F50 KLASİK SİSTEM ENTEĞRE CEPHE PROFİLLERİ

F50 CLASSIC SYSTEM
INTEGRATED FACADE PROFILE

ÜRÜN TEKNİK ÖZELLİKLERİ
PRODUCT'S TECHNICAL FEATURES

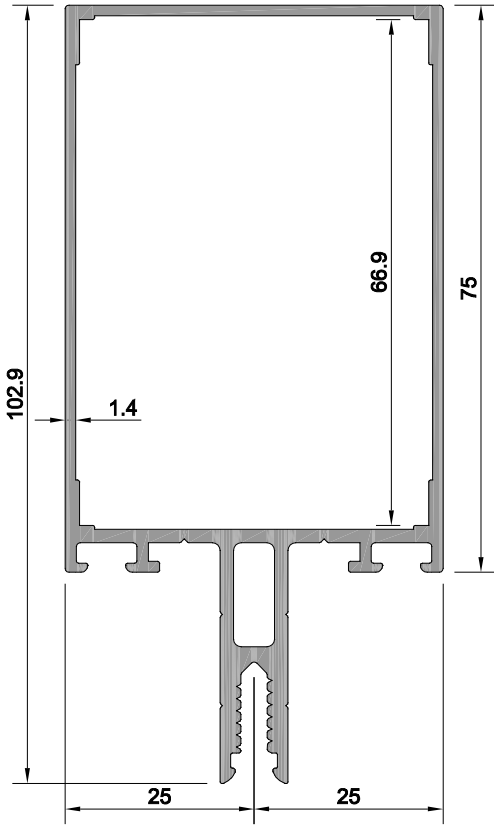

Profil No: **SC0103**
Ağırlık : 1484 gr/m
Ix : 57,03 cm⁴
Iy : 16,89 cm⁴
wx : 10,77 cm³
wy : 6,76 cm³



SC0310-3



SC0301-3



SC0302-3

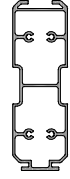

SC0316-2

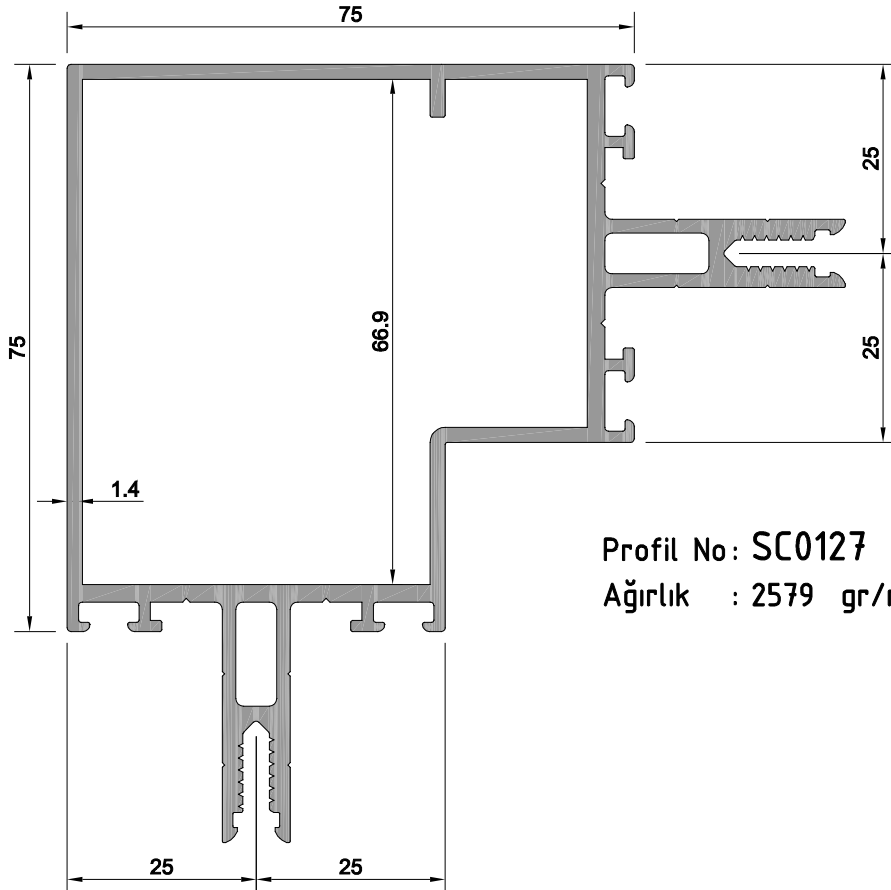

Profil No: **SC0127**
Ağırlık : 2579 gr/m

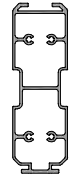



SC0316-2

F50 KLASİK SİSTEM ENTEĞRE CEPHE PROFİLLERİ

F50 CLASSIC SYSTEM
INTEGRATED FACADE PROFILE

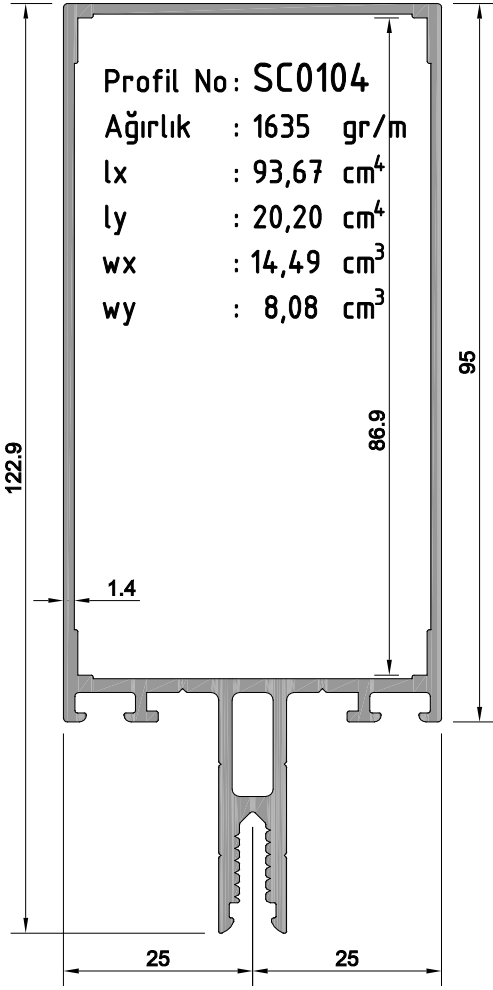
ÜRÜN TEKNİK ÖZELLİKLERİ
PRODUCT'S TECHNICAL FEATURES



 SC0310-4

 SC0301-4

 SC0302-4

 SC0316-3

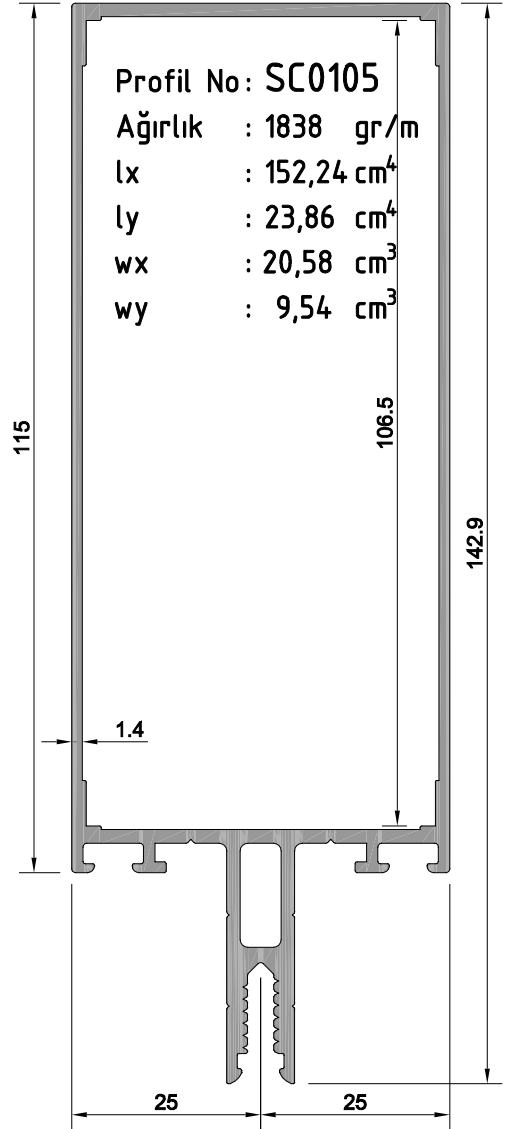

 SC0310-5

 SC0301-5

 SC0302-5

 SC0316-4

F50 KLASİK SİSTEM ENTEĞRE CEPHE PROFİLLERİ

F50 CLASSIC SYSTEM
INTEGRATED FACADE PROFILE

ÜRÜN TEKNİK ÖZELLİKLERİ
PRODUCT'S TECHNICAL FEATURES

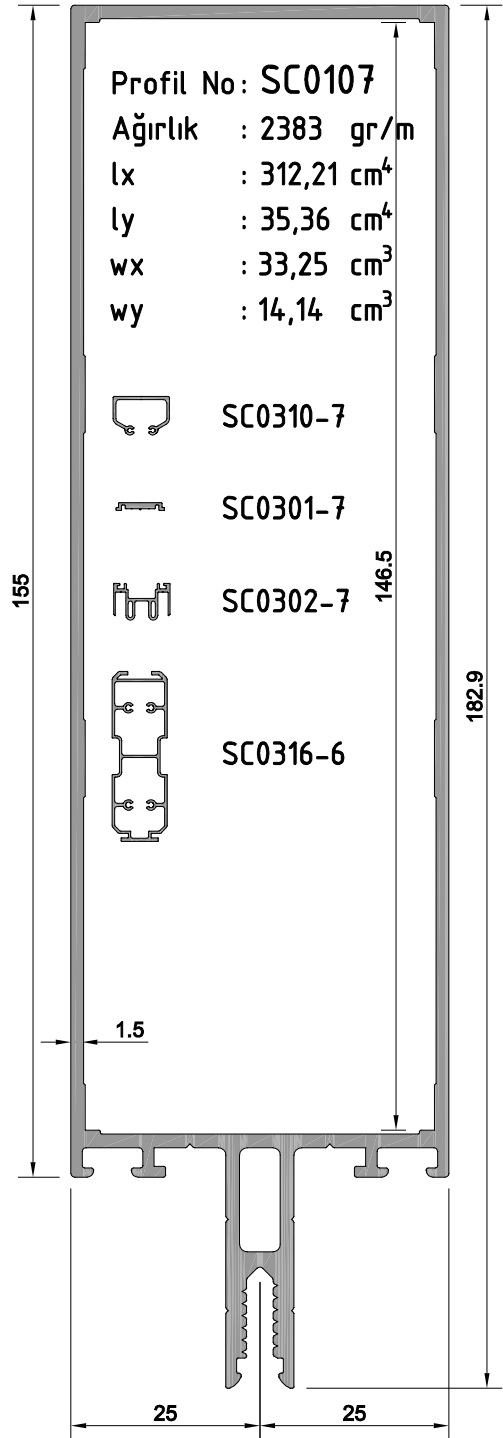
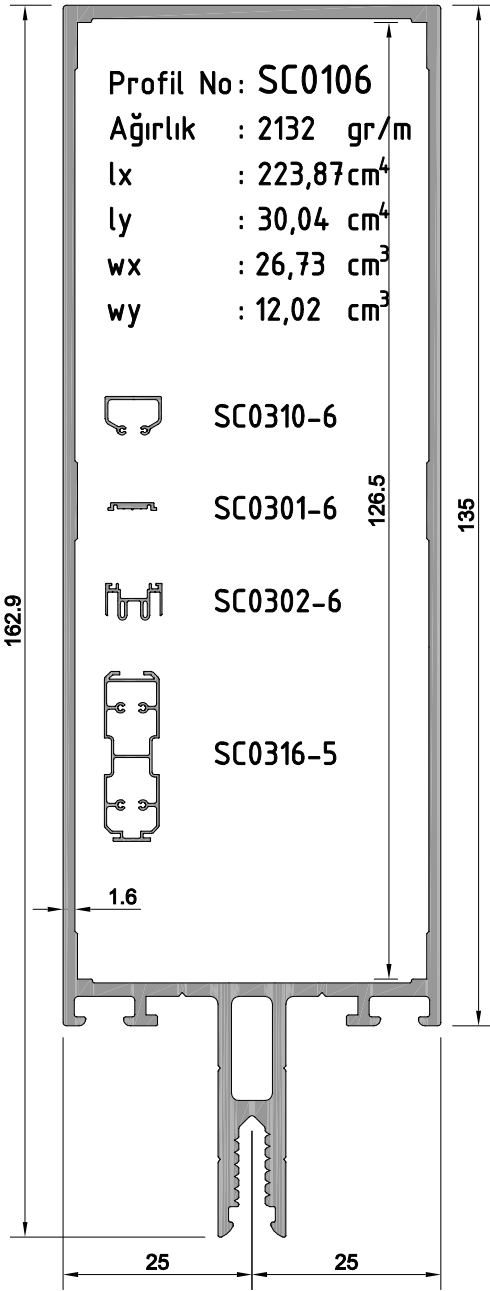

F50 KLASİK SİSTEM ENTEĞRE CEPHE PROFİLLERİ

F50 CLASSIC SYSTEM
INTEGRATED FACADE PROFILE

ÜRÜN TEKNİK ÖZELLİKLERİ
PRODUCT'S TECHNICAL FEATURES

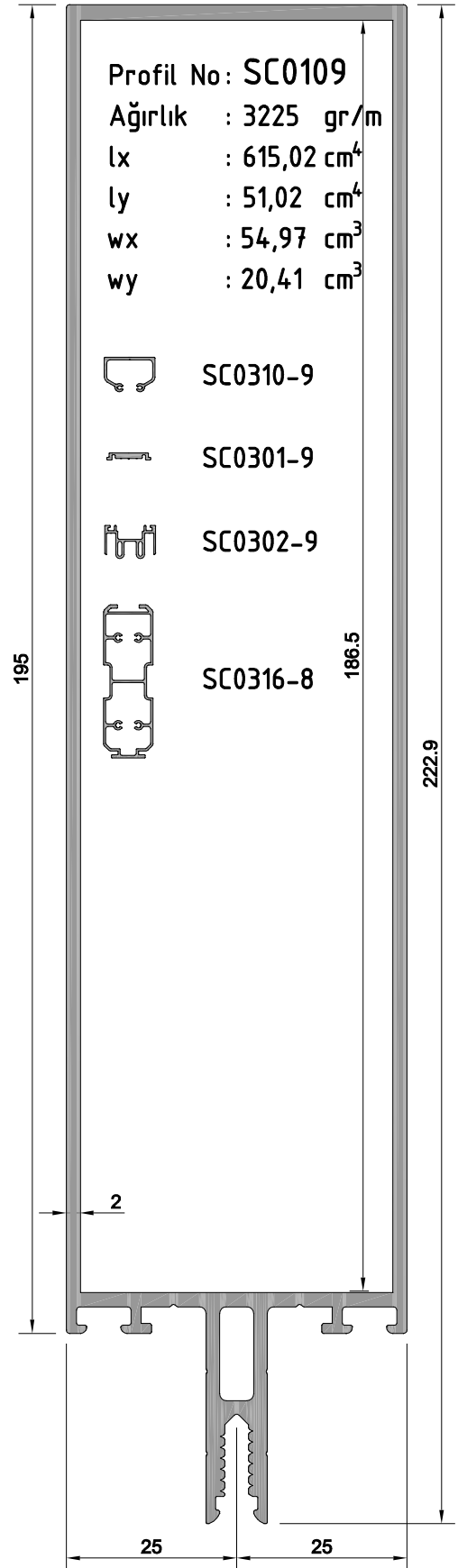
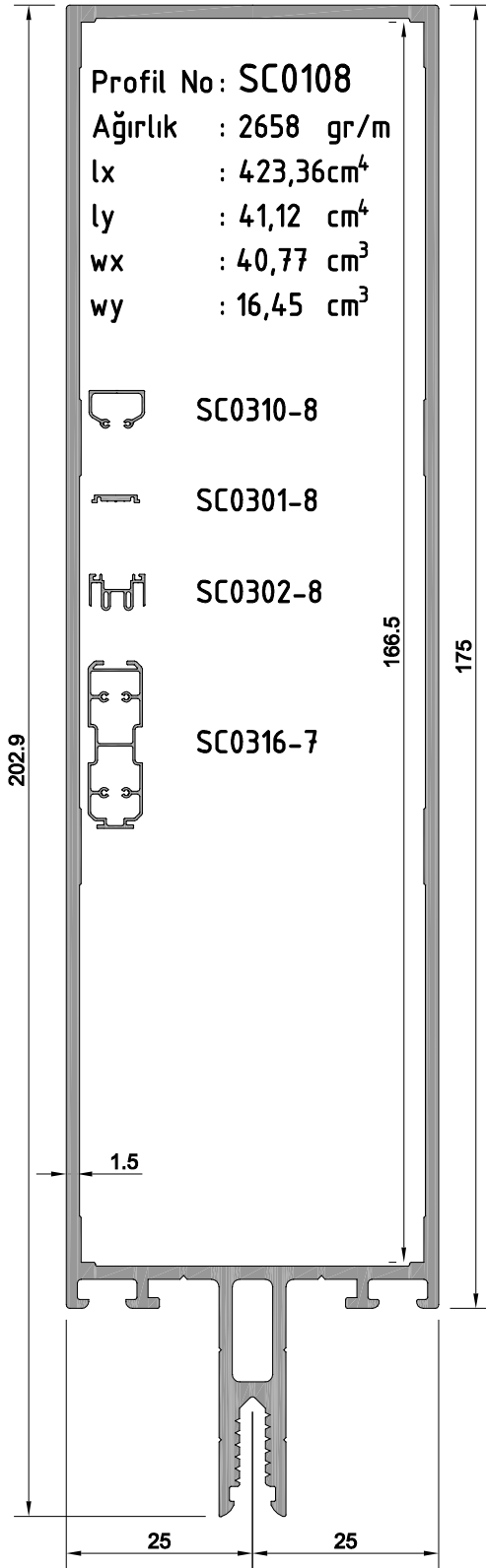

F50 KLASİK SİSTEM ENTEĞRE CEPHE PROFİLLERİ

F50 CLASSIC SYSTEM
INTEGRATED FACADE PROFILE

ÜRÜN TEKNİK ÖZELLİKLERİ
PRODUCT'S TECHNICAL FEATURES

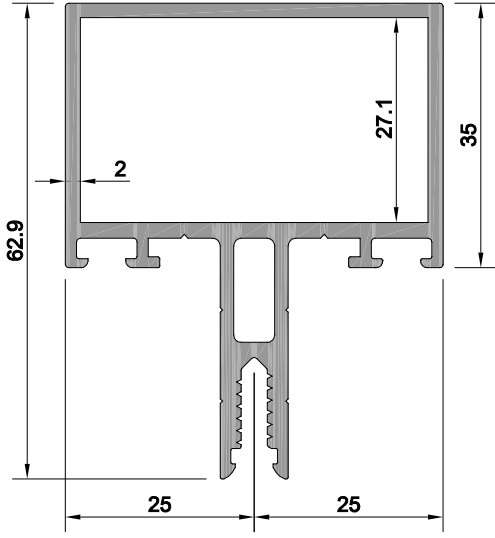

Profil No: SC0110 

Ağırlık : 1325 gr/m

I_x : 15,93 cm⁴

I_y : 11,84 cm⁴

w_x : 4,39 cm³

w_y : 4,73 cm³



SC0310-1



SC0301-1



SC0302-1

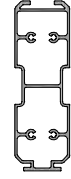

SC0316-0

 İşaretili profil için satış ekibinden bilgi alınır.

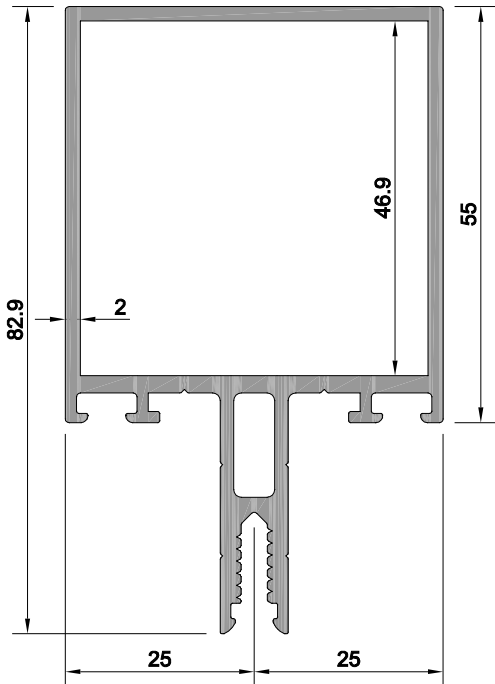

Profil No: SC0111

Ağırlık : 1567 gr/m

I_x : 35,63 cm⁴

I_y : 16,62 cm⁴

w_x : 8,03 cm³

w_y : 6,65 cm³



SC0310-2



SC0301-2



SC0302-2

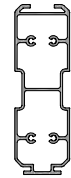

SC0316-1

F50 KLASİK SİSTEM ENTEĞRE CEPHE PROFİLLERİ

F50 CLASSIC SYSTEM
INTEGRATED FACADE PROFILE

ÜRÜN TEKNİK ÖZELLİKLERİ
PRODUCT'S TECHNICAL FEATURES

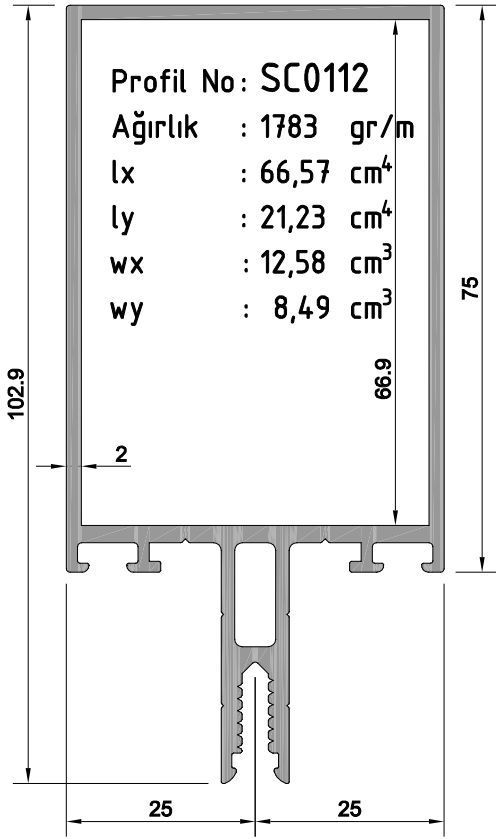

SC0310-3



SC0301-3



SC0302-3

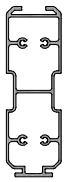

SC0316-2

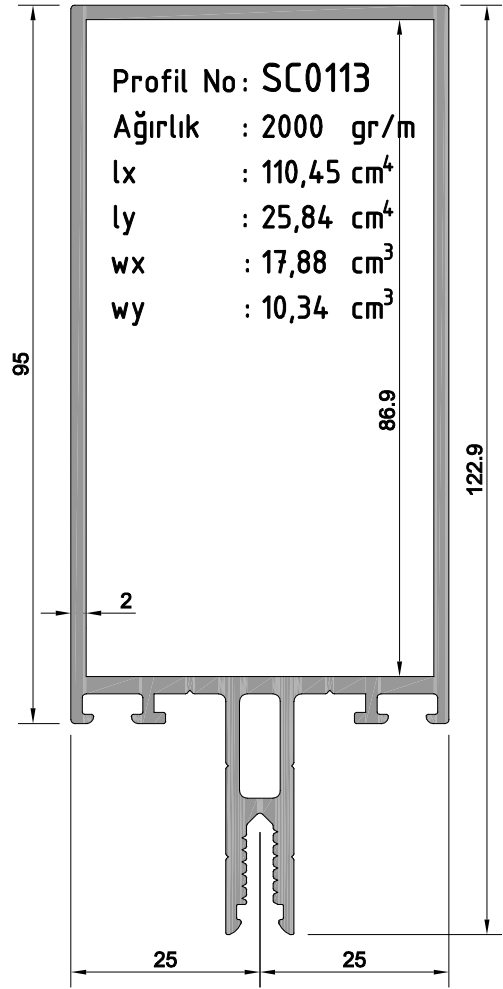

SC0310-4



SC0301-4



SC0302-4

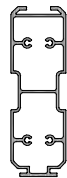

SC0316-3

F50 KLASİK SİSTEM ENTEĞRE CEPHE PROFİLLERİ

F50 CLASSIC SYSTEM
INTEGRATED FACADE PROFILE

ÜRÜN TEKNİK ÖZELLİKLERİ
PRODUCT'S TECHNICAL FEATURES

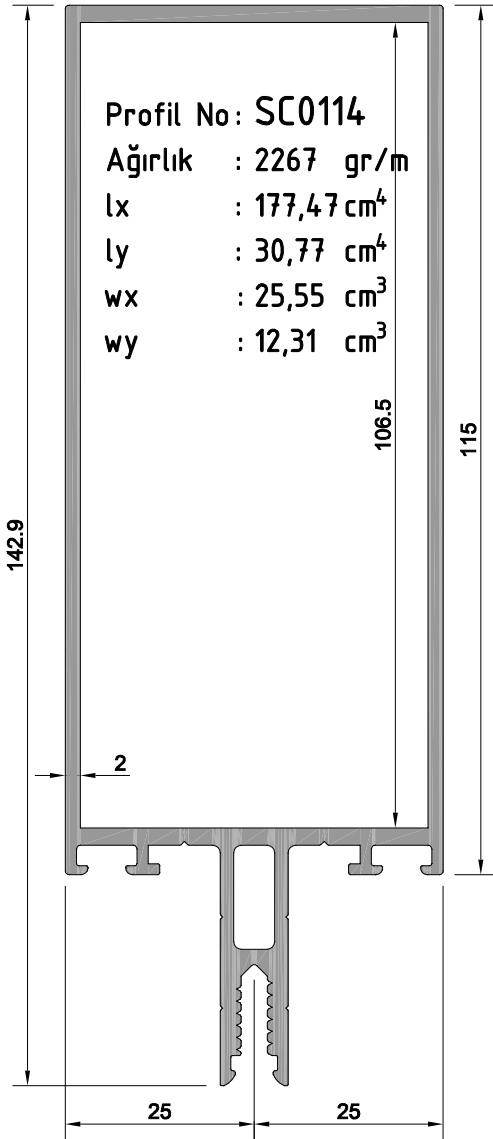

SC0310-5



SC0301-5



SC0302-5

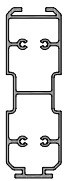

SC0316-4

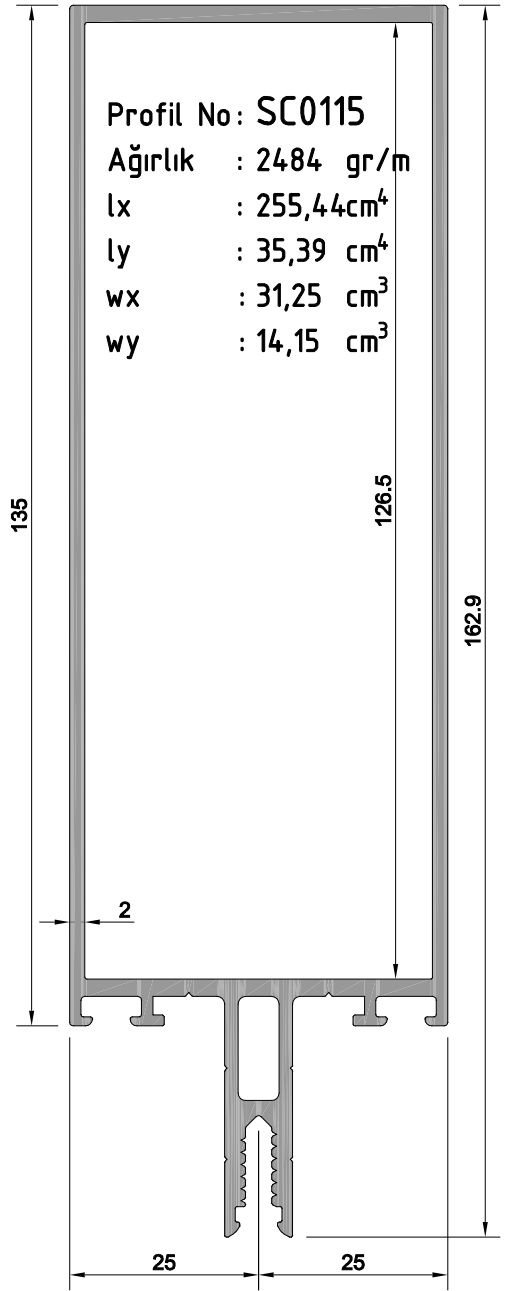

SC0310-6



SC0301-6



SC0302-6



SC0316-5

F50 KLASİK SİSTEM ENTEĞRE CEPHE PROFİLLERİ

F50 CLASSIC SYSTEM
INTEGRATED FACADE PROFILE

ÜRÜN TEKNİK ÖZELLİKLERİ
PRODUCT'S TECHNICAL FEATURES

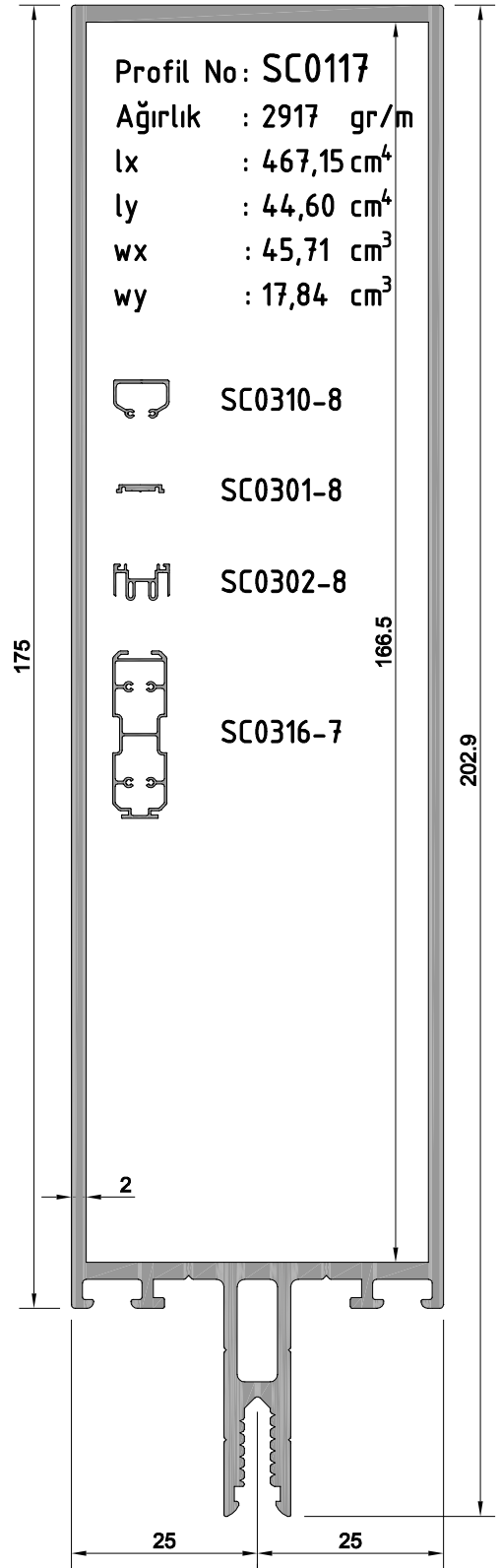
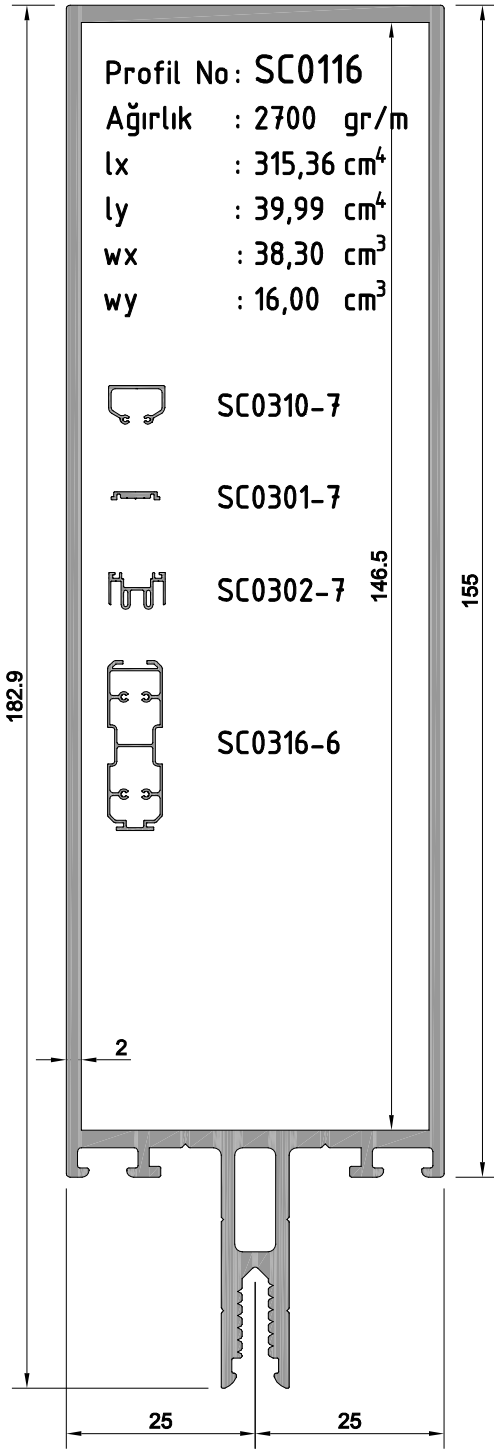

F50 KLASİK SİSTEM ENTEĞRE CEPHE PROFİLLERİ

F50 CLASSIC SYSTEM
INTEGRATED FACADE PROFILE

ÜRÜN TEKNİK ÖZELLİKLERİ
PRODUCT'S TECHNICAL FEATURES

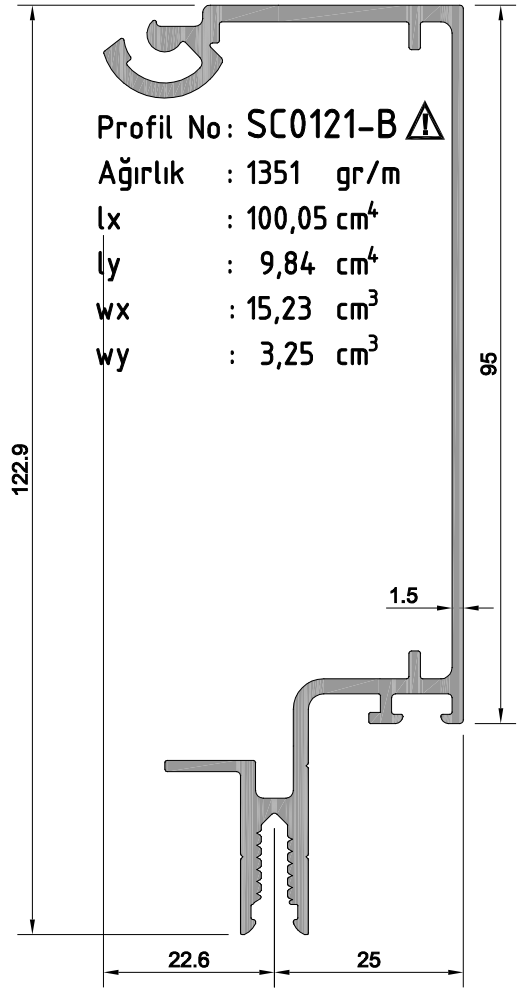
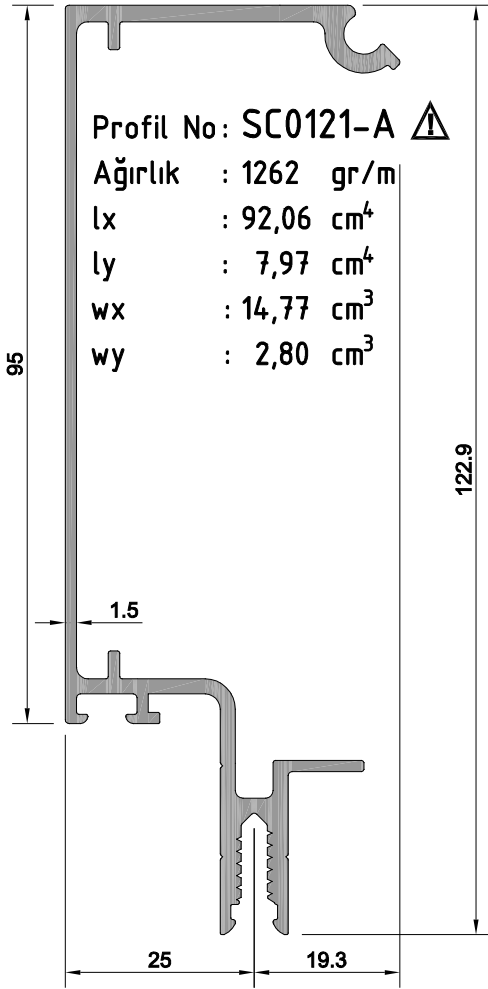

⚠ İşaretili profil için satış ekibinden bilgi alınır.

⚠ İşaretili profil için satış ekibinden bilgi alınır.

F50 KLASİK SİSTEM ENTEĞRE CEPHE PROFİLLERİ

F50 CLASSIC SYSTEM
INTEGRATED FACADE PROFILE

ÜRÜN TEKNİK ÖZELLİKLERİ
PRODUCT'S TECHNICAL FEATURES

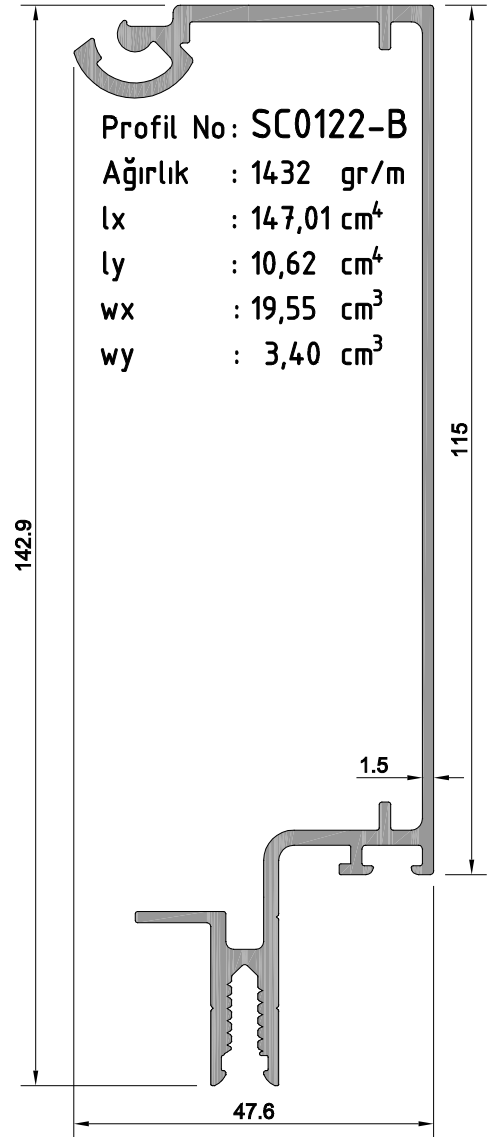
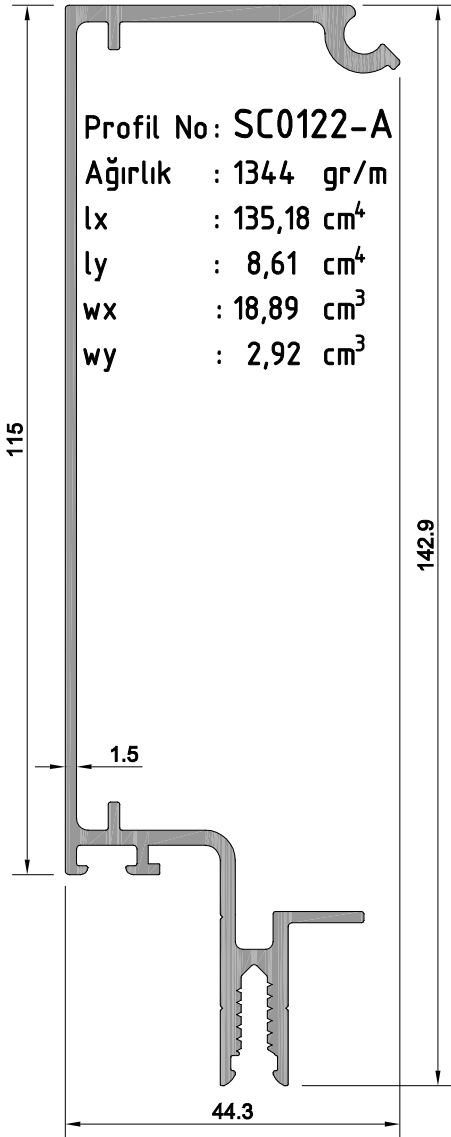

F50 KLASİK SİSTEM ENTEĞRE CEPHE PROFİLLERİ

F50 CLASSIC SYSTEM
INTEGRATED FACADE PROFILE

ÜRÜN TEKNİK ÖZELLİKLERİ
PRODUCT'S TECHNICAL FEATURES

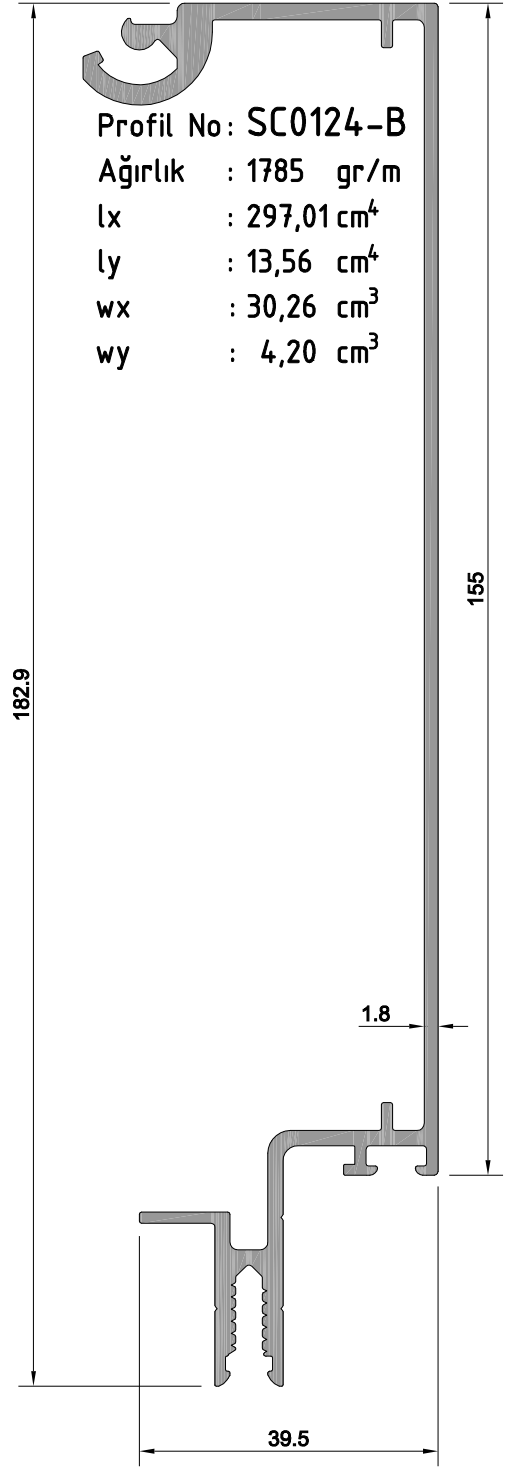
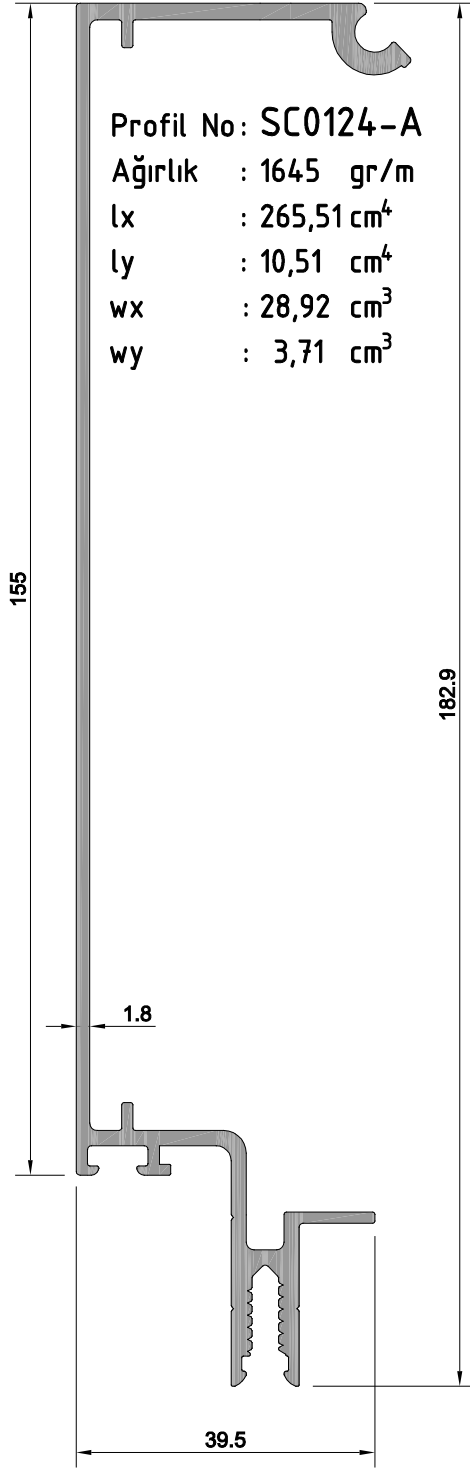

F50 KLASİK SİSTEM
ENTEĞRE CEPHE PROFİLLERİ
F50 CLASSIC SYSTEM
INTEGRATED FACADE PROFILE

ÜRÜN TEKNİK ÖZELLİKLERİ
PRODUCT'S TECHNICAL FEATURES

Profil No: SC0201 Ağırlık : 734 gr/m

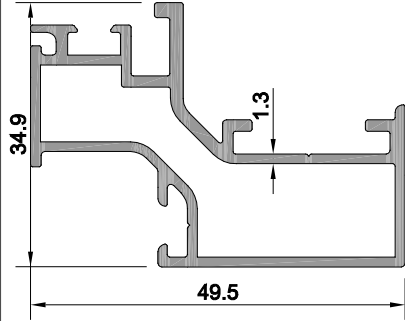

SC0308-a

SC0304-a

SC0307-a

Profil No: SC0218 Ağırlık : 1241 gr/m

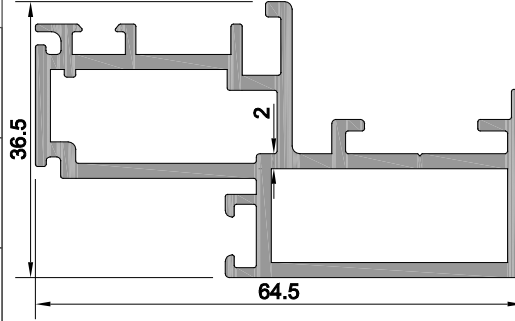

SC0308-b

SC0304-a

SC0308-g

Profil No: SC0210 Ağırlık : 1001 gr/m

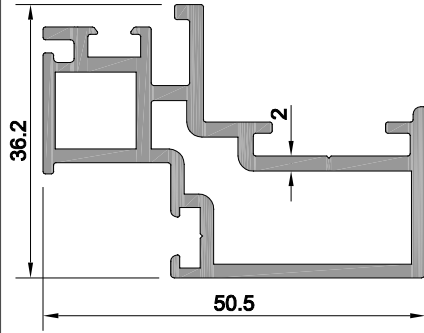

SC0308-a

SC0304-a

SC0307-a

Profil No: KC0201
Ağırlık : 737 gr/m

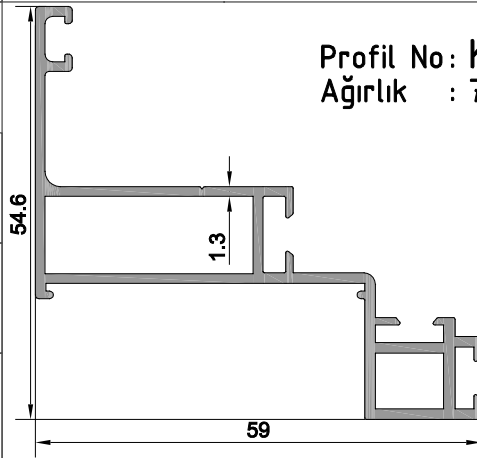

SC0307-b

SC0309-b

Profil No: SC0215

Ağırlık PVC : 1365 gr/m
Ağırlık POLY: 1350 gr/m

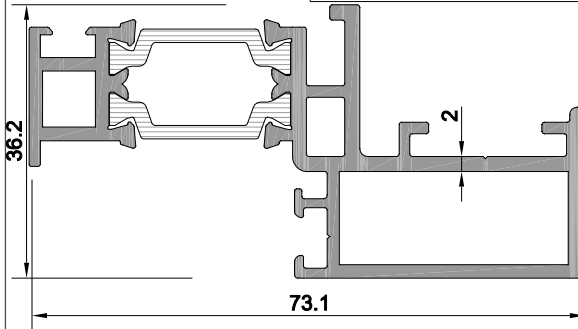

SC0308-b

SC0304-a

SC0309-a

Profil No: KC0202
Ağırlık : 792 gr/m

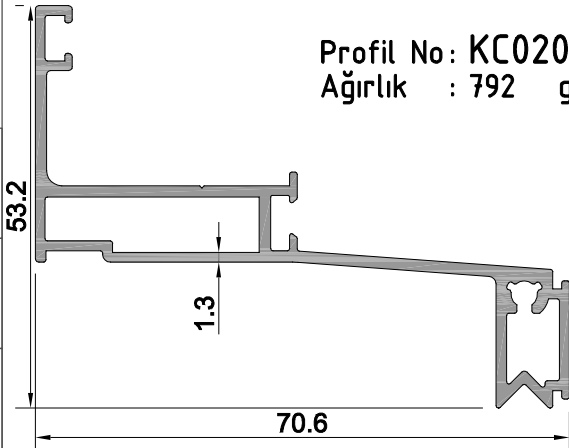

SC0309-c

Profil No: SC0216

Ağırlık PVC : 1060 gr/m
Ağırlık POLY: 1045 gr/m

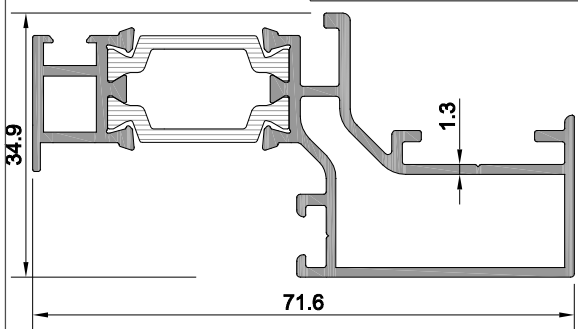

SC0308-b

SC0304-a

SC0309-a

Profil No: KC0204
Ağırlık : 1463 gr/m

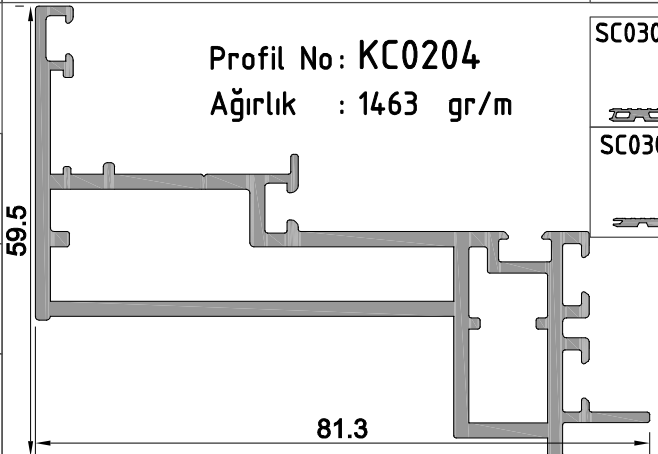

SC0308-h

SC0309-j

Profil değerleri teoriktir. Ağırlık olarak testimde yapılan tartım geçerlidir.
Profil imalatları TS EN 12020-2 ve TS EN 755-9 toleransı,
Moment değerleri EN 14024'e göre hesaplanmıştır.

Profile values are theoretical pre-shipment weight will be valid.
The tolerances of Profile manufacturing are calculated according to EN 12020-2
and TS EN 755-9; moment values are calculated according to EN 14024.

F50 KLASİK SİSTEM ENTEĞRE CEPHE PROFİLLERİ

F50 CLASSIC SYSTEM
INTEGRATED FACADE PROFILE

ÜRÜN TEKNİK ÖZELLİKLERİ
PRODUCT'S TECHNICAL FEATURES

SC0201

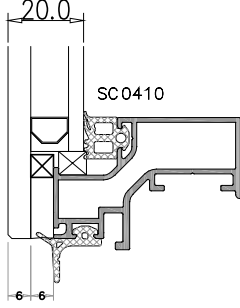

SC0210

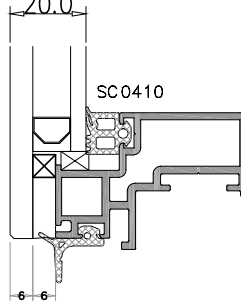

SC0204

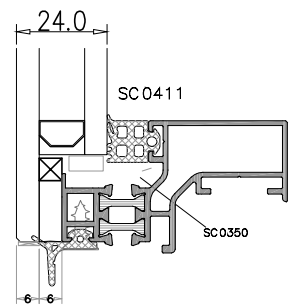
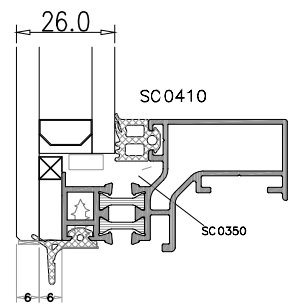
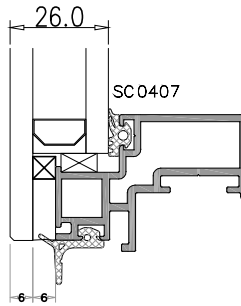
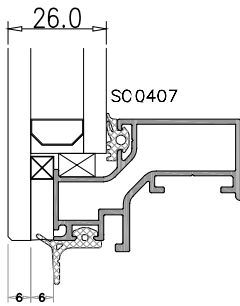
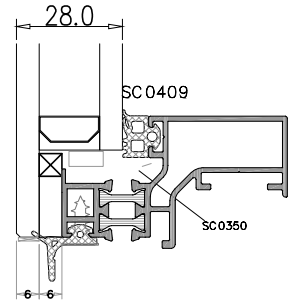
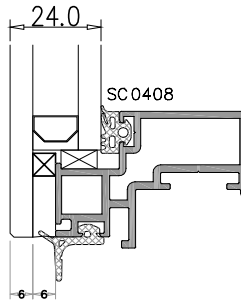
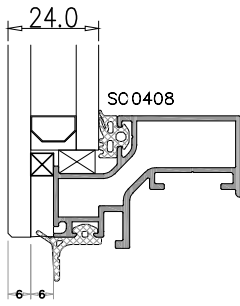
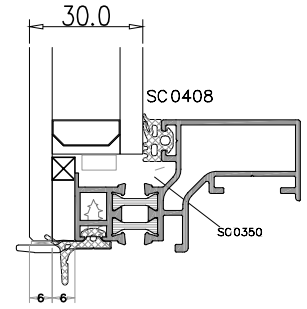
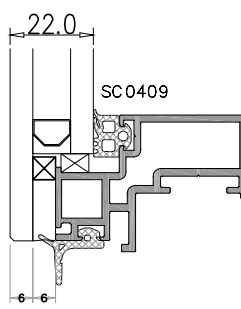
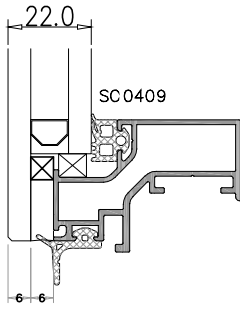
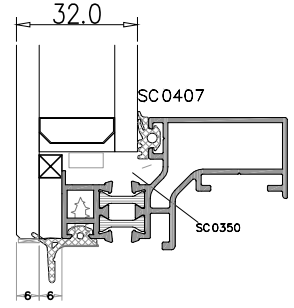

Profil değerleri teoriktir. Ağırlık olarak testimde yapılan tartım geçerlidir.
Profil imalatları TS EN 12020-2 ve TS EN 755-9 toleransı,
Moment değerleri EN 14024'e göre hesaplanmıştır.

Profile values are theoretical pre-shipment weight will be valid.
The tolerances of Profile manufacturing are calculated according to EN 12020-2
and TS EN 755-9; moment values are calculated according to EN 14024.

F50 KLASİK SİSTEM ENTEĞRE CEPHE PROFİLLERİ

F50 CLASSIC SYSTEM
INTEGRATED FACADE PROFILE

ÜRÜN TEKNİK ÖZELLİKLERİ
PRODUCT'S TECHNICAL FEATURES

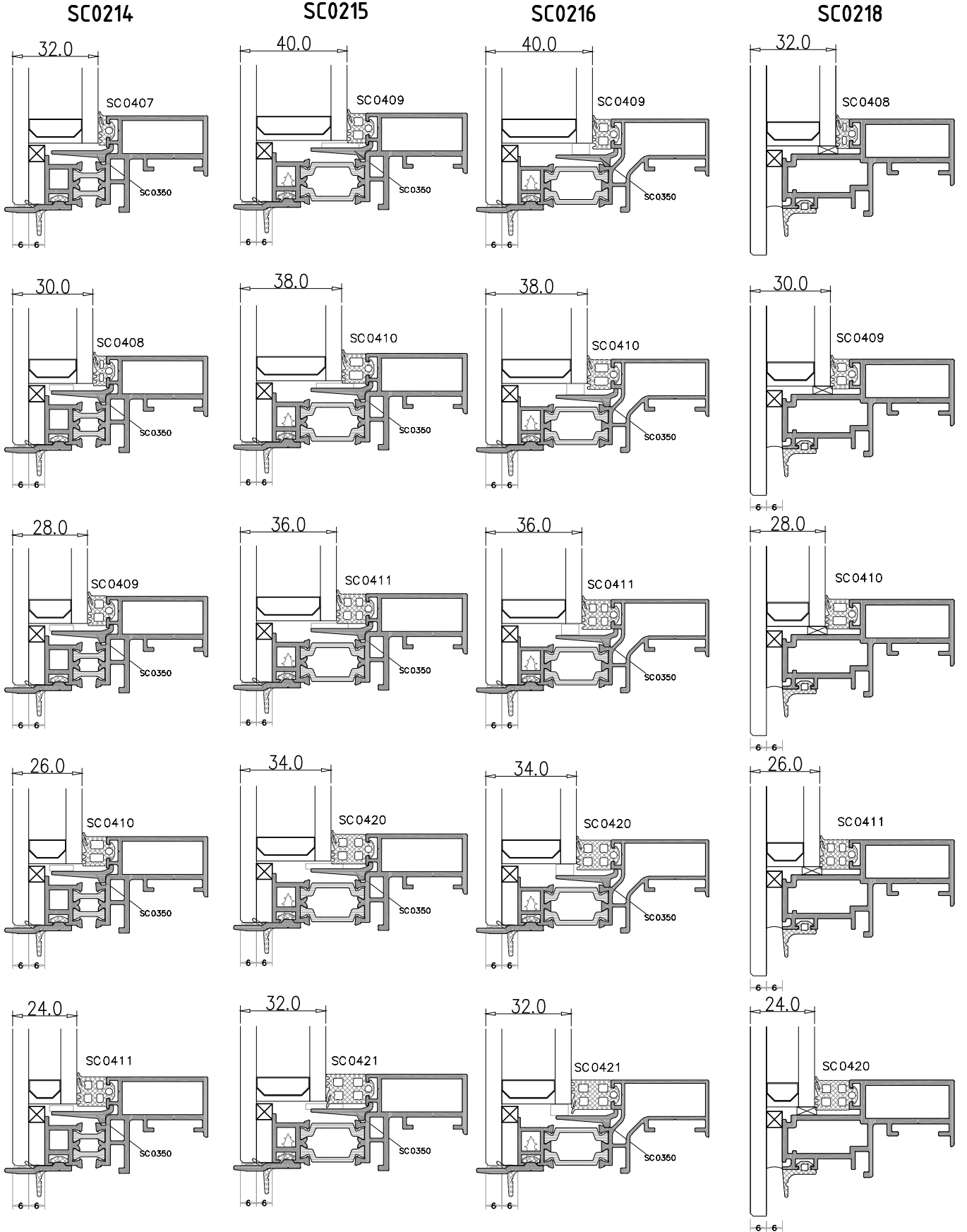

Profil değerleri teoriktir. Ağırlık olarak testimde yapılan tartım geçerlidir.
Profil imalatları TS EN 12020-2 ve TS EN 755-9 toleransı,
Moment değerleri EN 14024'e göre hesaplanmıştır.

Profile values are theoretical pre-shipment weight will be valid.
The tolerances of Profile manufacturing are calculated according to EN 12020-2
and TS EN 755-9; moment values are calculated according to EN 14024.

F50 KLASİK SİSTEM ENTEĞRE CEPHE PROFİLLERİ

F50 CLASSIC SYSTEM
INTEGRATED FACADE PROFILE

ÜRÜN TEKNİK ÖZELLİKLERİ
PRODUCT'S TECHNICAL FEATURES

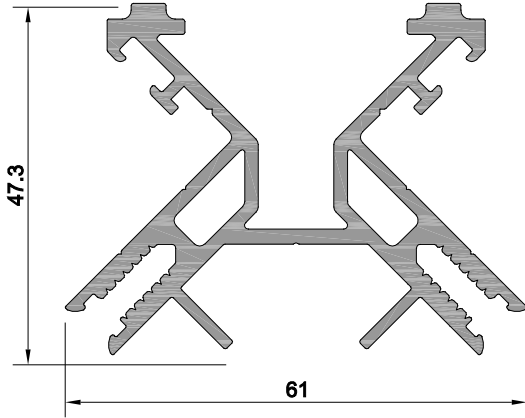

Profil No: KC0303
Ağırlık : 1463gr/m

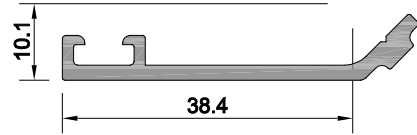

Profil No: KC0308
Ağırlık : 329 gr/m

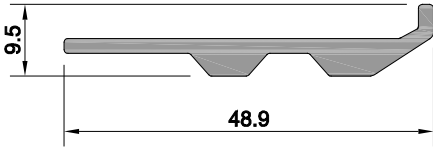

Profil No: EC0302
Ağırlık : 419 gr/m

EC0302-a	50 mm	100 adet/pcs
----------	-------	--------------

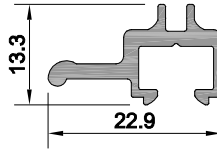

Profil No: EC0301
Ağırlık : 223 gr/m

EC0301-a	50 mm	100 adet/pcs
----------	-------	--------------

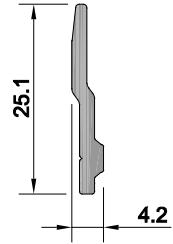

Profil No: SC0312
Ağırlık : 147 gr/m

SC0312-a	50 mm	100 adet/pcs
----------	-------	--------------

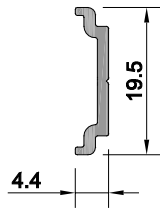

Profil No: SC0303
Ağırlık : 96 gr/m

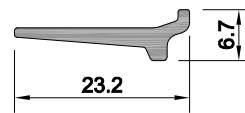

Profil No: SC0350
Ağırlık : 140 gr/m

SC0350-a	50 mm	100 adet/pcs
----------	-------	--------------

F50 KLASİK SİSTEM ENTEĞRE CEPHE PROFİLLERİ

F50 CLASSIC SYSTEM
INTEGRATED FACADE PROFILE

ÜRÜN TEKNİK ÖZELLİKLERİ
PRODUCT'S TECHNICAL FEATURES

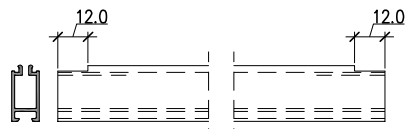
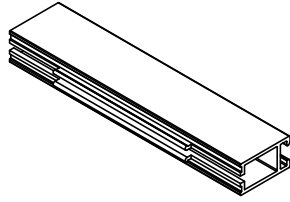
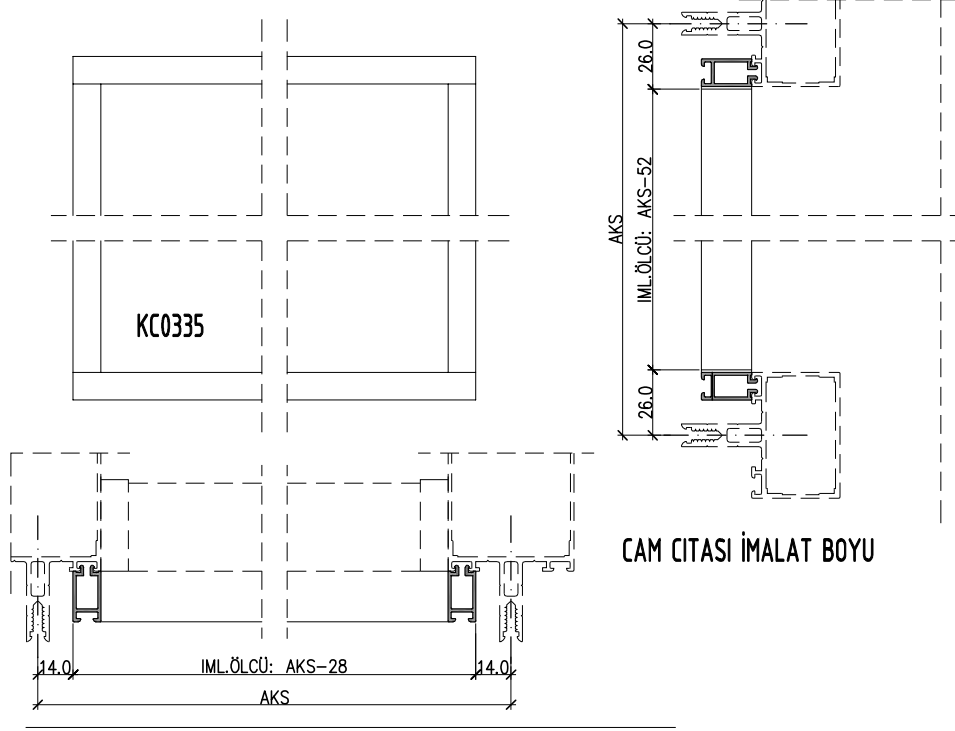

YATAY CAM CİTASI İŞLEM ŞEKLİ

F50 KLASİK SİSTEM ENTEĞRE CEPHE PROFİLLERİ

F50 CLASSIC SYSTEM
INTEGRATED FACADE PROFILE

ÜRÜN TEKNİK ÖZELLİKLERİ
PRODUCT'S TECHNICAL FEATURES

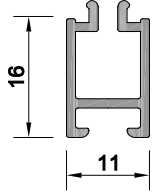

Profil No: KC0333
Ağırlık : 179 gr/m

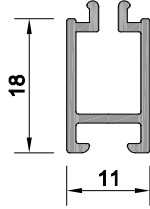

Profil No: KC0334
Ağırlık : 192 gr/m

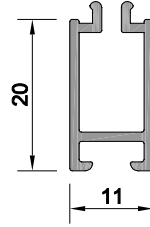

Profil No: KC0331
Ağırlık : 207 gr/m

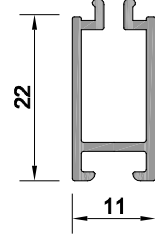

Profil No: KC0332
Ağırlık : 218 gr/m

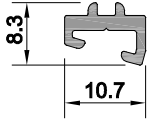

Profil No: KC0340
Ağırlık : 98 gr/m

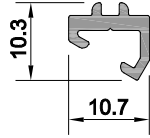

Profil No: KC0341
Ağırlık : 105 gr/m

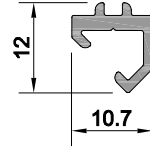

Profil No: KC0342
Ağırlık : 112 gr/m

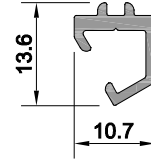

Profil No: KC0343
Ağırlık : 123 gr/m

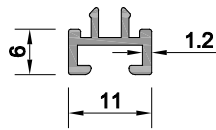

Profil No: KC0350
Ağırlık : 96 gr/m

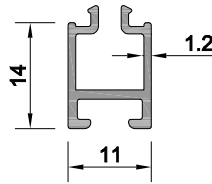

Profil No: KC0351
Ağırlık : 151 gr/m

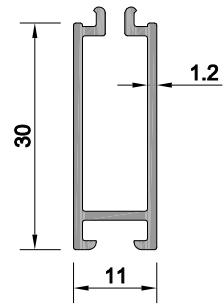

Profil No: KC0352 ⚠
Ağırlık : 270 gr/m

⚠ İşaretili profil için satış ekibinden bilgi alınır.

F50 KLASİK SİSTEM ENTEĞRE CEPHE PROFİLLERİ

F50 CLASSIC SYSTEM
INTEGRATED FACADE PROFILE

ÜRÜN TEKNİK ÖZELLİKLERİ
PRODUCT'S TECHNICAL FEATURES

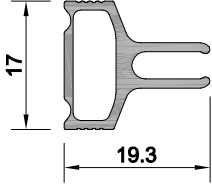

Profil No: EC0201
Ağırlık : 220 gr/m

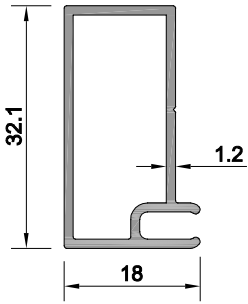
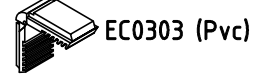

Profil No: EC0202
Ağırlık : 323 gr/m

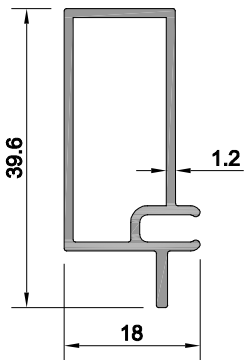

Profil No: EC0203
Ağırlık : 353 gr/m



F50 KLASİK SİSTEM ENTEĞRE CEPHE PROFİLLERİ

F50 CLASSIC SYSTEM
INTEGRATED FACADE PROFILE

ÜRÜN TEKNİK ÖZELLİKLERİ
PRODUCT'S TECHNICAL FEATURES

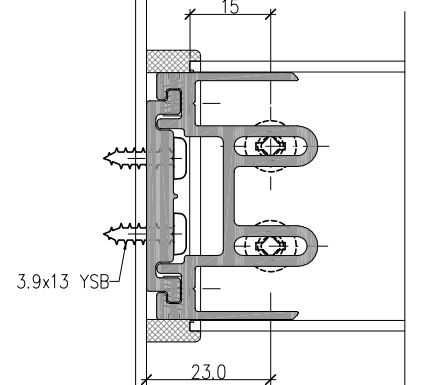
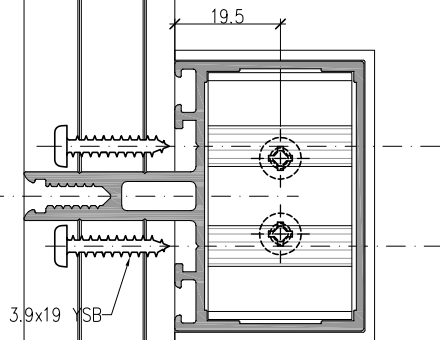
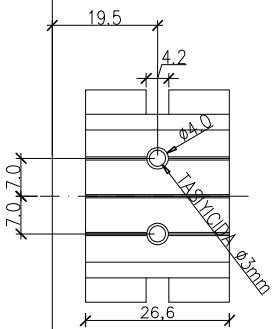
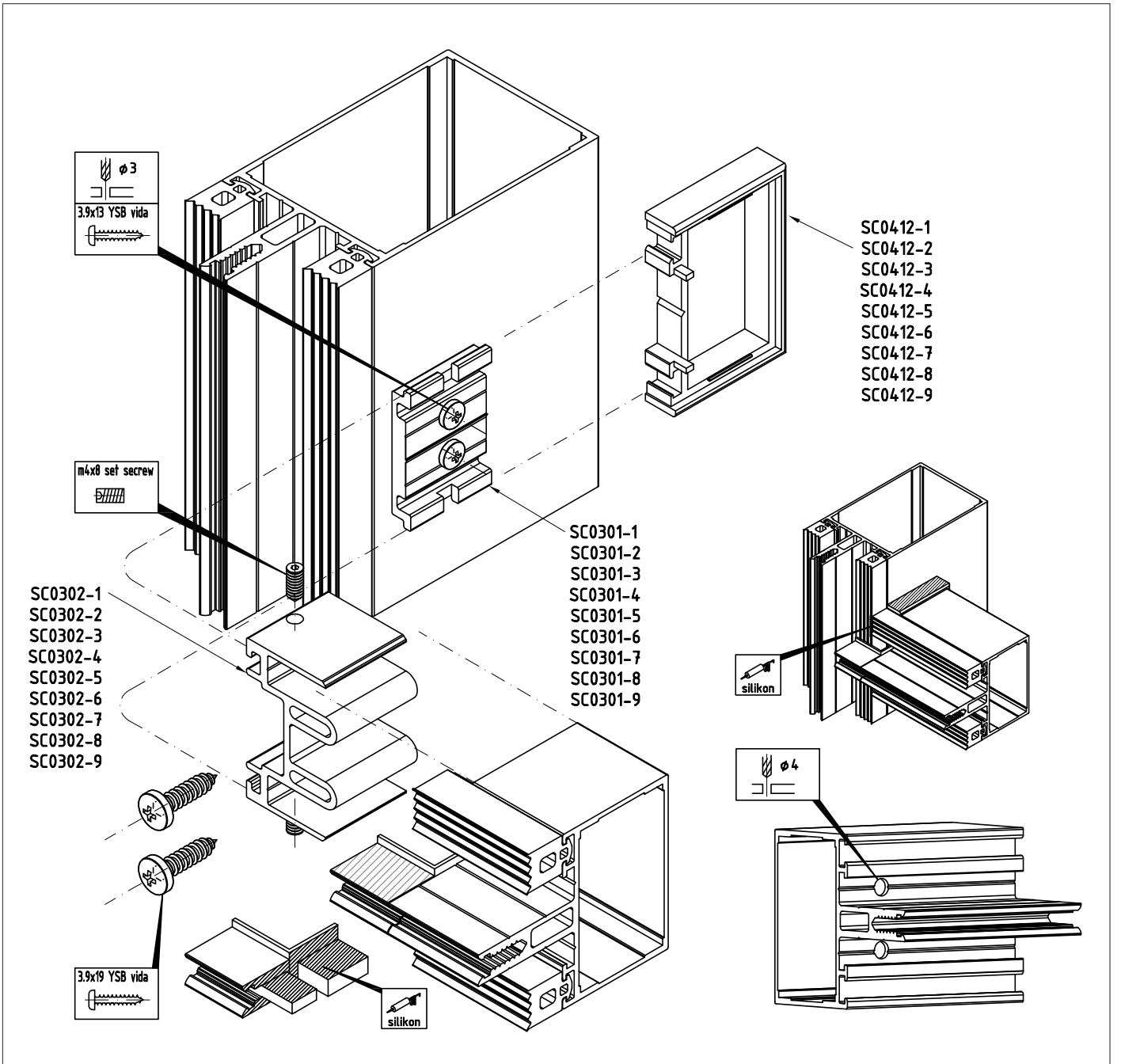

Profil değerleri teoriktir. Ağırlık olarak testimde yapılan tartım geçerlidir.
Profil imatları TS EN 12020-2 ve TS EN 755-9 toleransı,
Moment değerleri EN 14024'e göre hesaplanmıştır.

Profile values are theoretical pre-shipment weight will be valid.
The tolerances of Profile manufacturing are calculated according to EN 12020-2
and TS EN 755-9; moment values are calculated according to EN 14024.

F50 KLASİK SİSTEM
ENTEĞRE CEPHE PROFİLLERİ
F50 CLASSIC SYSTEM
INTEGRATED FACADE PROFILE

ÜRÜN TEKNİK ÖZELLİKLERİ
PRODUCT'S TECHNICAL FEATURES

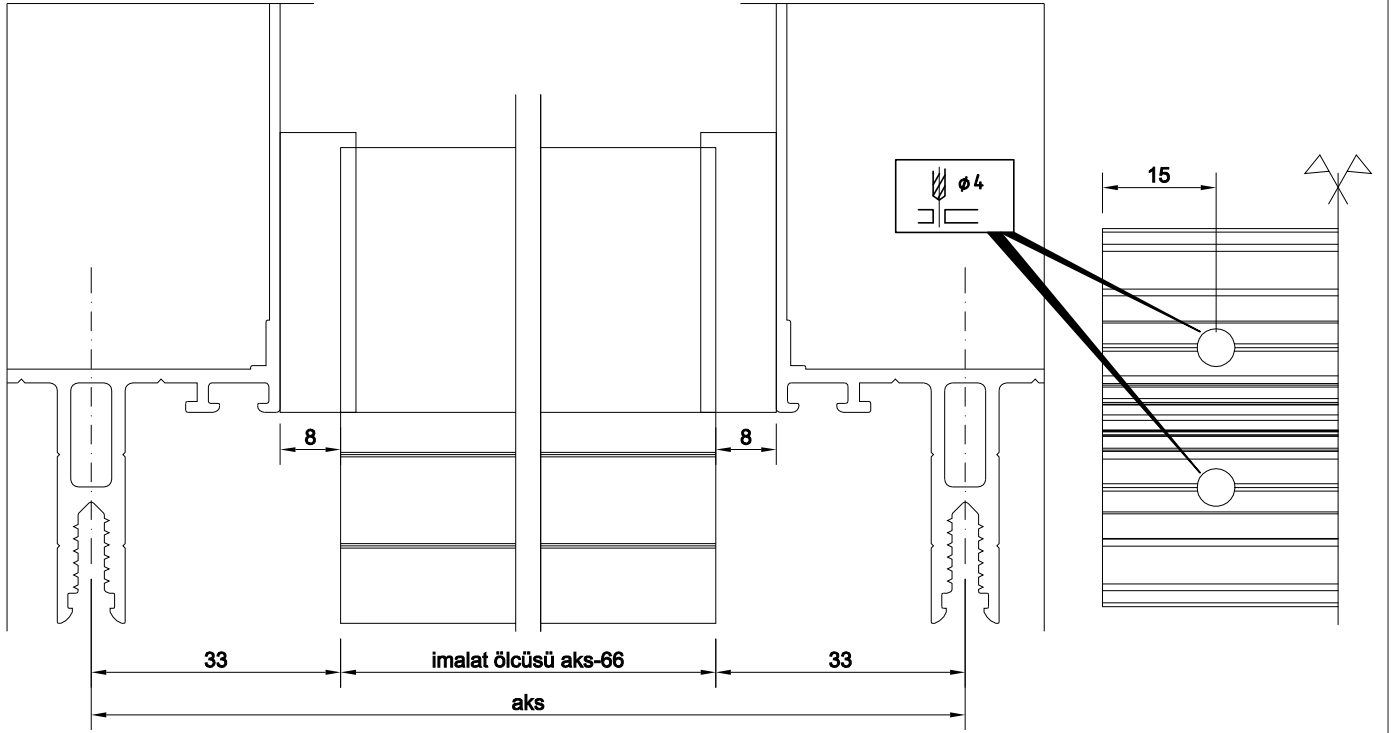

SC0301-1	SC0302-1	26.6mm	100 adet/pcs
SC0301-2	SC0302-2	46.4mm	100 adet/pcs
SC0301-3	SC0302-3	66.4mm	100 adet/pcs
SC0301-4	SC0302-4	86.4mm	100 adet/pcs
SC0301-5	SC0302-5	106mm	100 adet/pcs
SC0301-6	SC0302-6	126mm	100 adet/pcs
SC0301-7	SC0302-7	146mm	100 adet/pcs
SC0301-8	SC0302-8	166mm	100 adet/pcs
SC0301-9	SC0302-9	186mm	100 adet/pcs

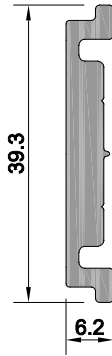

Profil No: SC0301
Ağırlık : 470 gr/m

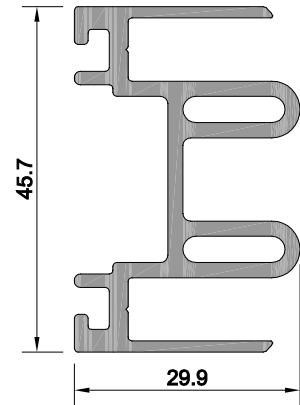

Profil No: SC0302
Ağırlık : 1002 gr/m

F50 KLASİK SİSTEM ENTEĞRE CEPHE PROFİLLERİ

F50 CLASSIC SYSTEM
INTEGRATED FACADE PROFILE

ÜRÜN TEKNİK ÖZELLİKLERİ
PRODUCT'S TECHNICAL FEATURES

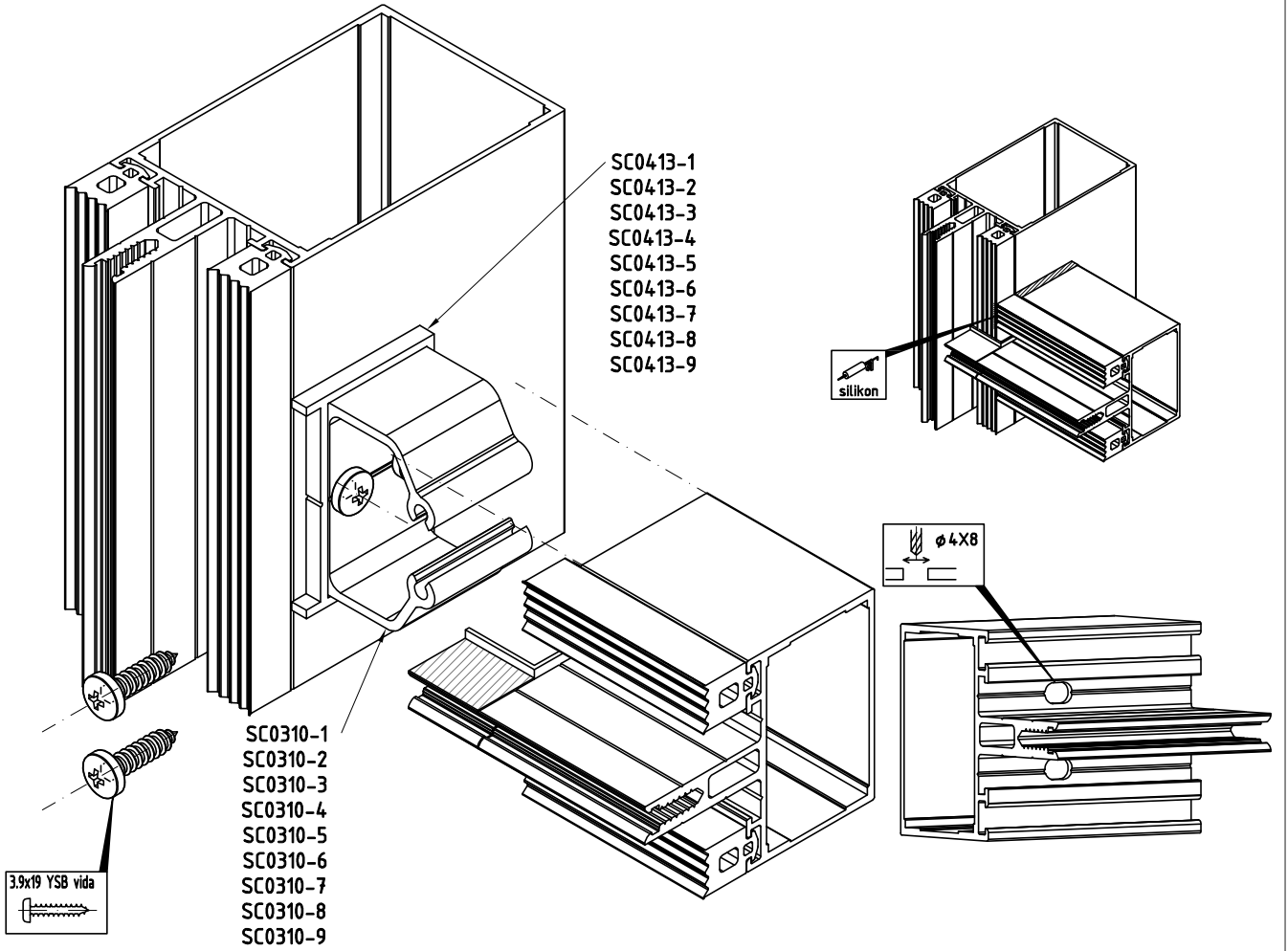

14.2

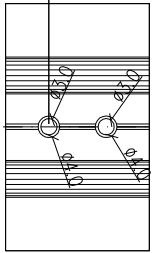

14.2

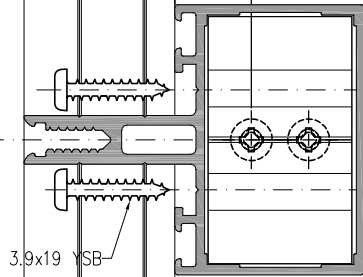

3.9x19 YSB

3.9x13 YSB

25

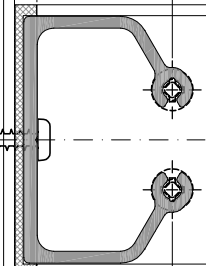

29

F50 KLASİK SİSTEM ENTEĞRE CEPHE PROFİLLERİ

F50 CLASSIC SYSTEM
INTEGRATED FACADE PROFILE

ÜRÜN TEKNİK ÖZELLİKLERİ
PRODUCT'S TECHNICAL FEATURES

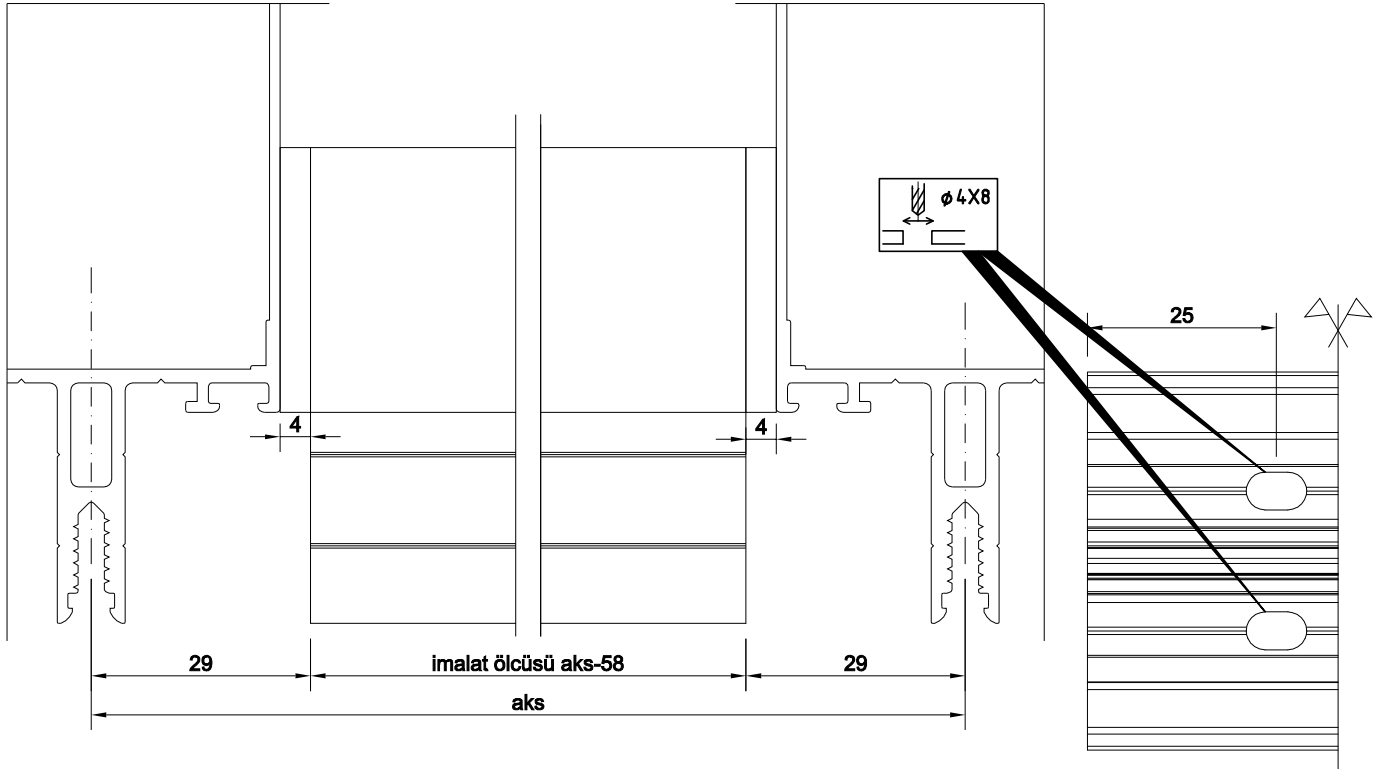

SC0310-1	26.6mm	100 adet/pcs
SC0310-2	46.4mm	100 adet/pcs
SC0310-3	66.4mm	100 adet/pcs
SC0310-4	86.4mm	100 adet/pcs
SC0310-5	106mm	100 adet/pcs
SC0310-6	126mm	100 adet/pcs
SC0310-7	146mm	100 adet/pcs
SC0310-8	166mm	100 adet/pcs
SC0310-9	186mm	100 adet/pcs

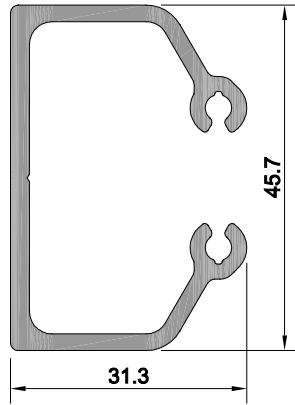

Profil No: SC0310

Ağırlık : 821 gr/m

F50 KLASİK SİSTEM ENTEĞRE CEPHE PROFİLLERİ

F50 CLASSIC SYSTEM
INTEGRATED FACADE PROFILE

ÜRÜN TEKNİK ÖZELLİKLERİ
PRODUCT'S TECHNICAL FEATURES

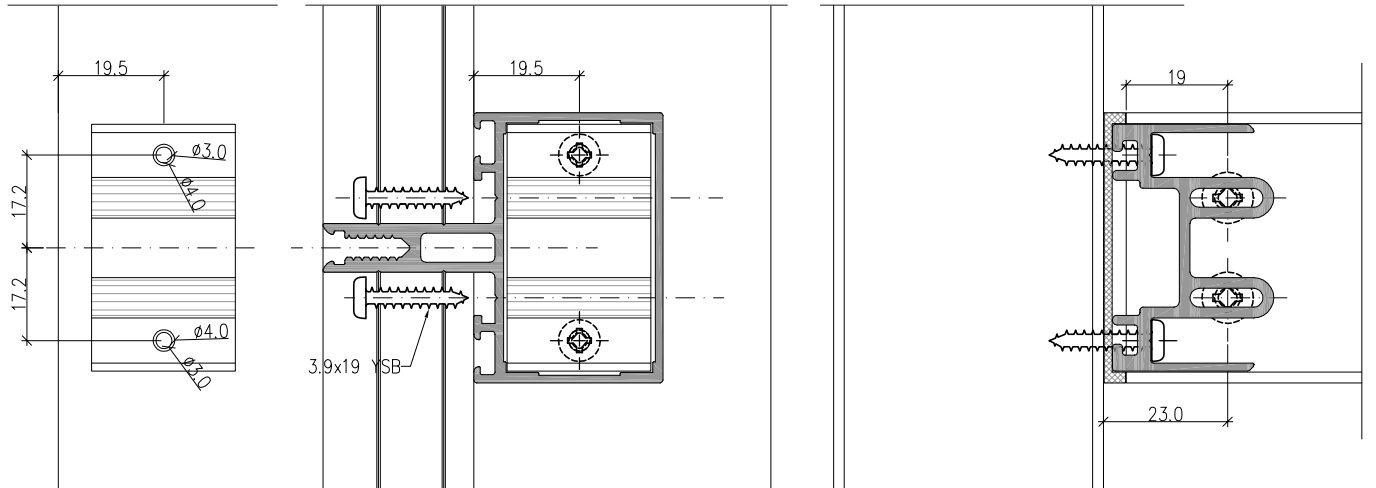
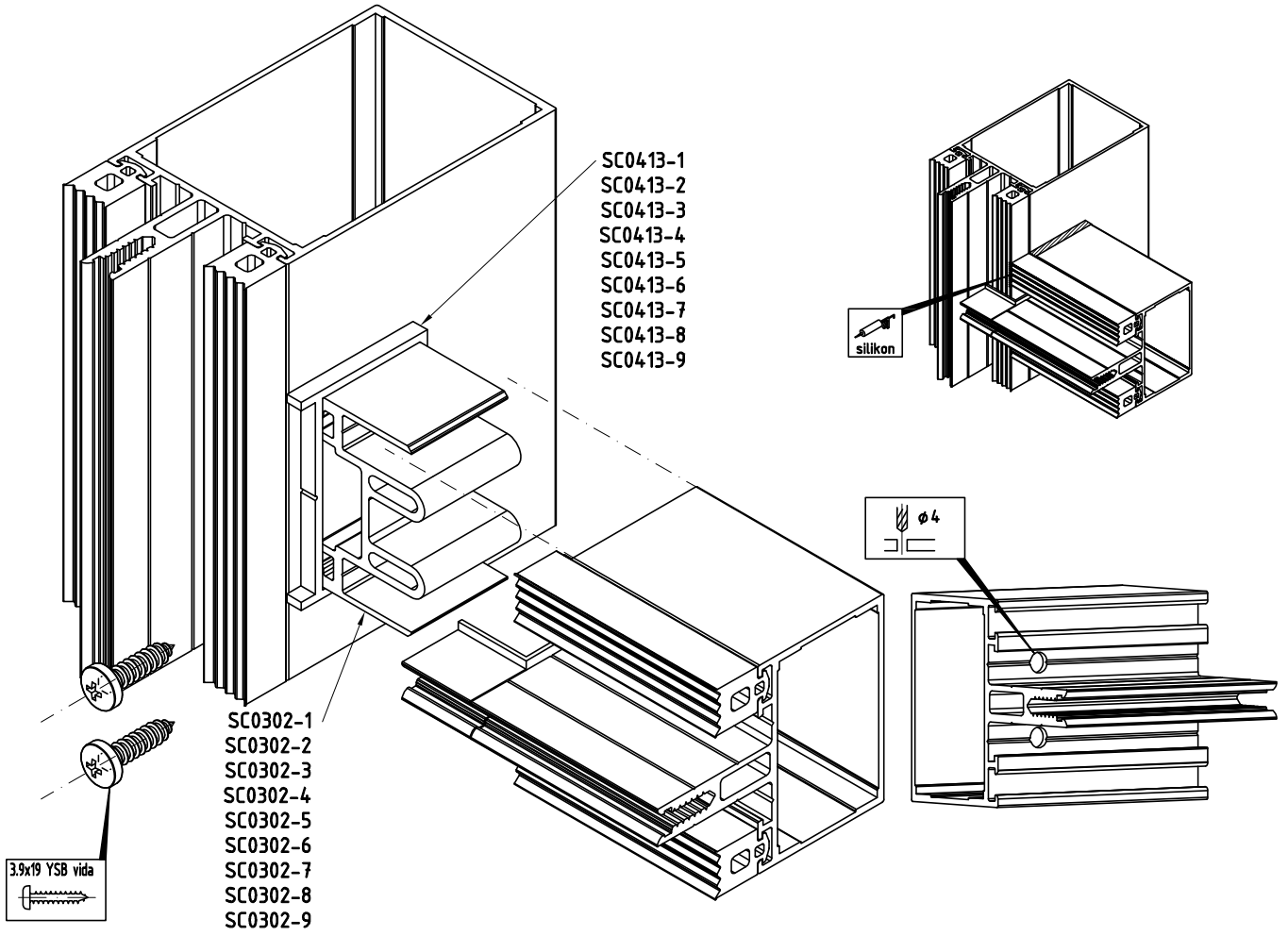

Profil değerleri teoriktir. Ağırlık olarak testimde yapılan tartım geçerlidir.
Profil imalatları TS EN 12020-2 ve TS EN 755-9 toleransı,
Moment değerleri EN 14024'e göre hesaplanmıştır.

Profile values are theoretical pre-shipment weight will be valid.
The tolerances of Profile manufacturing are calculated according to EN 12020-2
and TS EN 755-9; moment values are calculated according to EN 14024.

F50 KLASİK SİSTEM ENTEĞRE CEPHE PROFİLLERİ

F50 CLASSIC SYSTEM
INTEGRATED FACADE PROFILE

ÜRÜN TEKNİK ÖZELLİKLERİ
PRODUCT'S TECHNICAL FEATURES

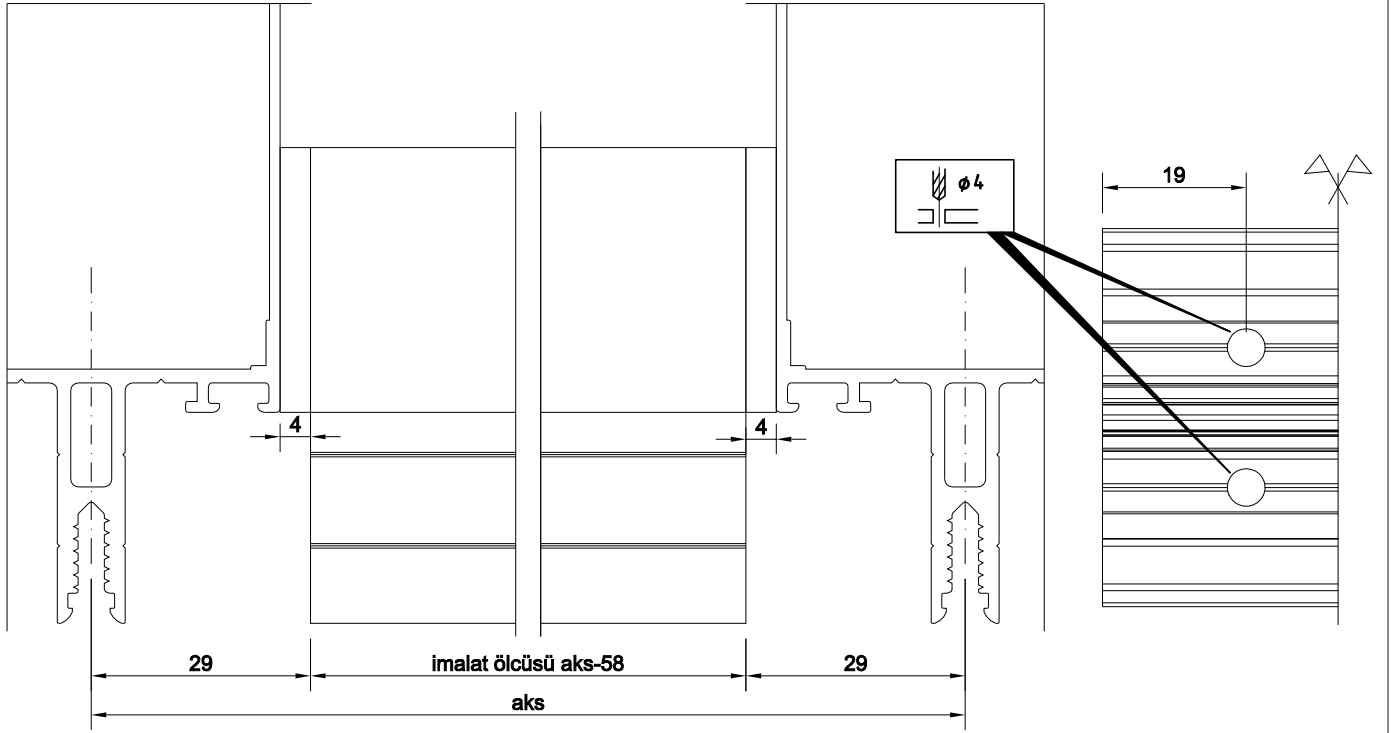

SC0302-1	26.6mm	100 adet/pcs
SC0302-2	46.4mm	100 adet/pcs
SC0302-3	66.4mm	100 adet/pcs
SC0302-4	86.4mm	100 adet/pcs
SC0302-5	106mm	100 adet/pcs
SC0302-6	126mm	100 adet/pcs
SC0302-7	146mm	100 adet/pcs
SC0302-8	166mm	100 adet/pcs
SC0302-9	186mm	100 adet/pcs

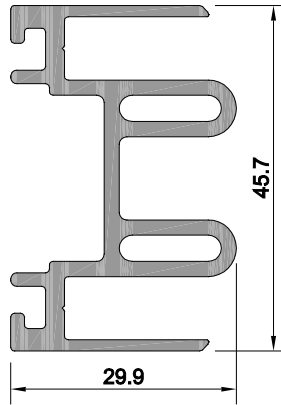

Profil No: SC0302
Ağırlık : 1002 gr/m

F50 KLASİK SİSTEM ENTEĞRE CEPHE PROFİLLERİ

F50 CLASSIC SYSTEM
INTEGRATED FACADE PROFILE

ÜRÜN ÖLÇÜLERİ
PRODUCT DIMENSIONS

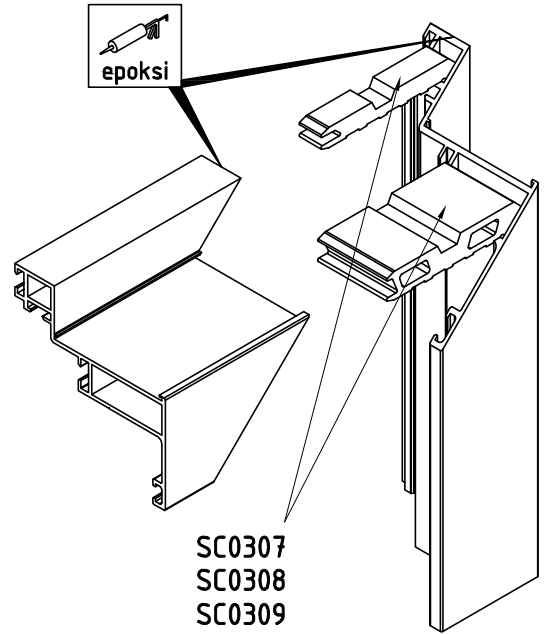
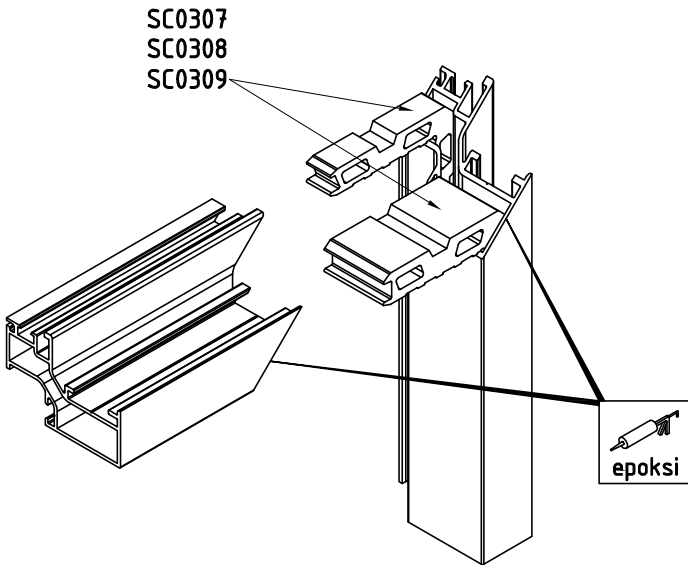
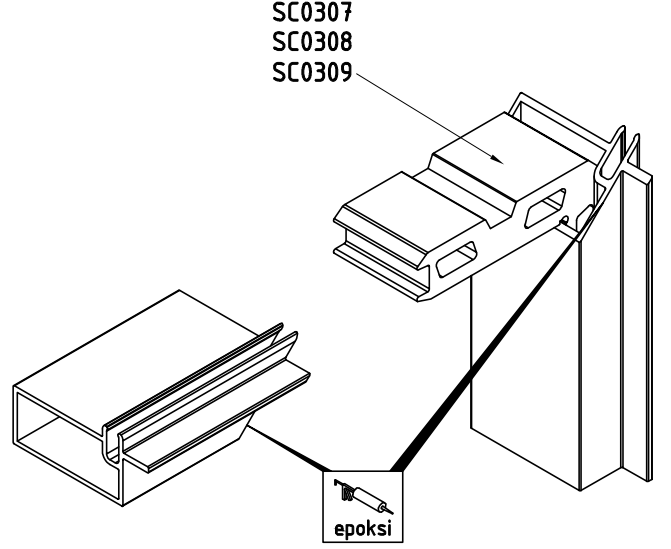
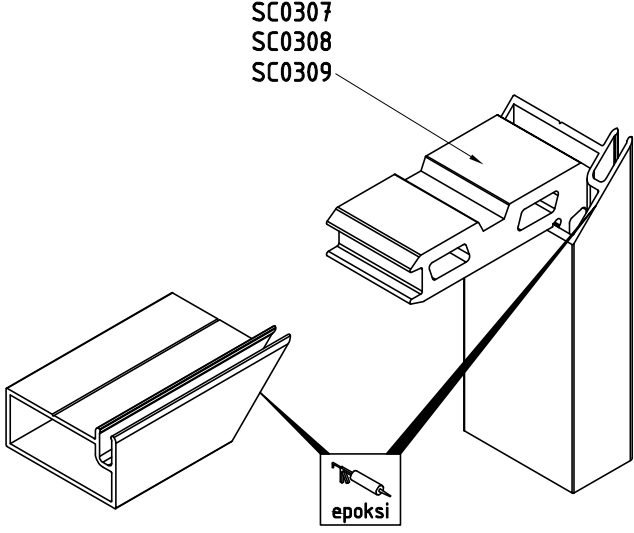

F50 KLASİK SİSTEM ENTEĞRE CEPHE PROFİLLERİ

F50 CLASSIC SYSTEM
INTEGRATED FACADE PROFILE

ÜRÜN TEKNİK ÖZELLİKLERİ
PRODUCT'S TECHNICAL FEATURES

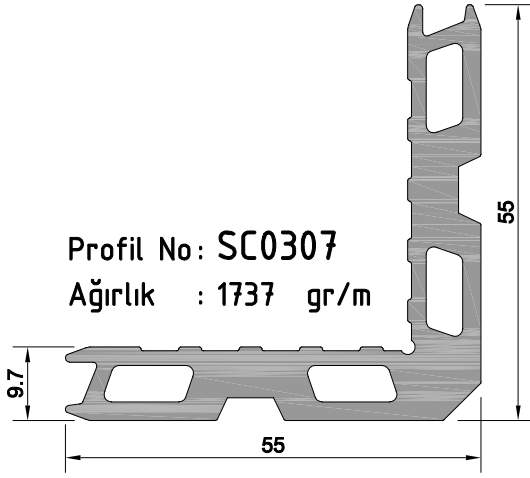

SC0307-a	10.25mm	100 adet/pcs	SC0307-f	25.6mm	100 adet/pcs
SC0307-b	27mm	100 adet/pcs	SC0307-g	6mm	100 adet/pcs
SC0307-c	8.5mm	100 adet/pcs	SC0307-h	4.7mm	100 adet/pcs
SC0307-d	23.9mm	100 adet/pcs	SC0307-i	26.28mm	100 adet/pcs
SC0307-e	6.3mm	100 adet/pcs	SC0307-j	29.5mm	100 adet/pcs

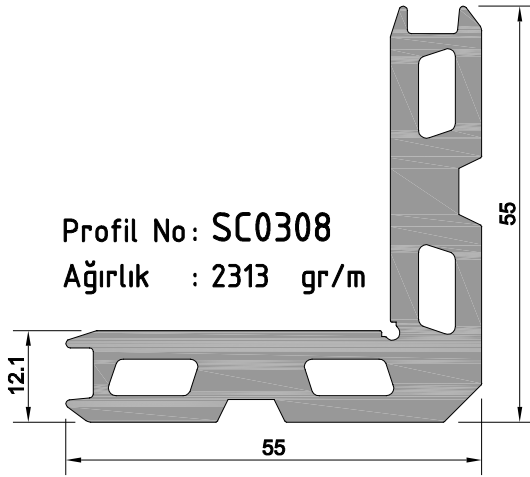

SC0308-a	25.68mm	100 adet/pcs
SC0308-b	29.74mm	100 adet/pcs
SC0308-c	24.36mm	100 adet/pcs
SC0308-d	10.30mm	100 adet/pcs
SC0308-e	6.70mm	100 adet/pcs
SC0308-f	23mm	100 adet/pcs
SC0308-g	19.50mm	100 adet/pcs

SC0308-h	9.9mm	100 adet/pcs
----------	-------	--------------

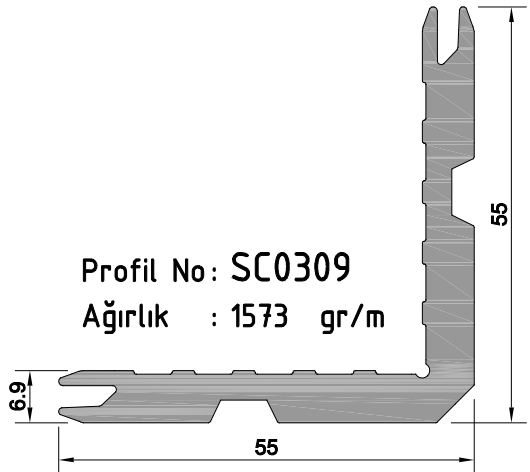

SC0309-a	6.5mm	100 adet/pcs	SC0309-f	4.7mm	100 adet/pcs
SC0309-b	8.5mm	100 adet/pcs	SC0309-g	54.2mm	100 adet/pcs
SC0309-c	18.9mm	100 adet/pcs	SC0309-h	23.8mm	100 adet/pcs
SC0309-d	20mm	100 adet/pcs	SC0309-i	48.2mm	100 adet/pcs
SC0309-e	25.3mm	100 adet/pcs	SC0309-j	52.8mm	100 adet/pcs

F50 KLASİK SİSTEM ENTEĞRE CEPHE PROFİLLERİ

F50 CLASSIC SYSTEM
INTEGRATED FACADE PROFILE

ÜRÜN TEKNİK ÖZELLİKLERİ
PRODUCT'S TECHNICAL FEATURES

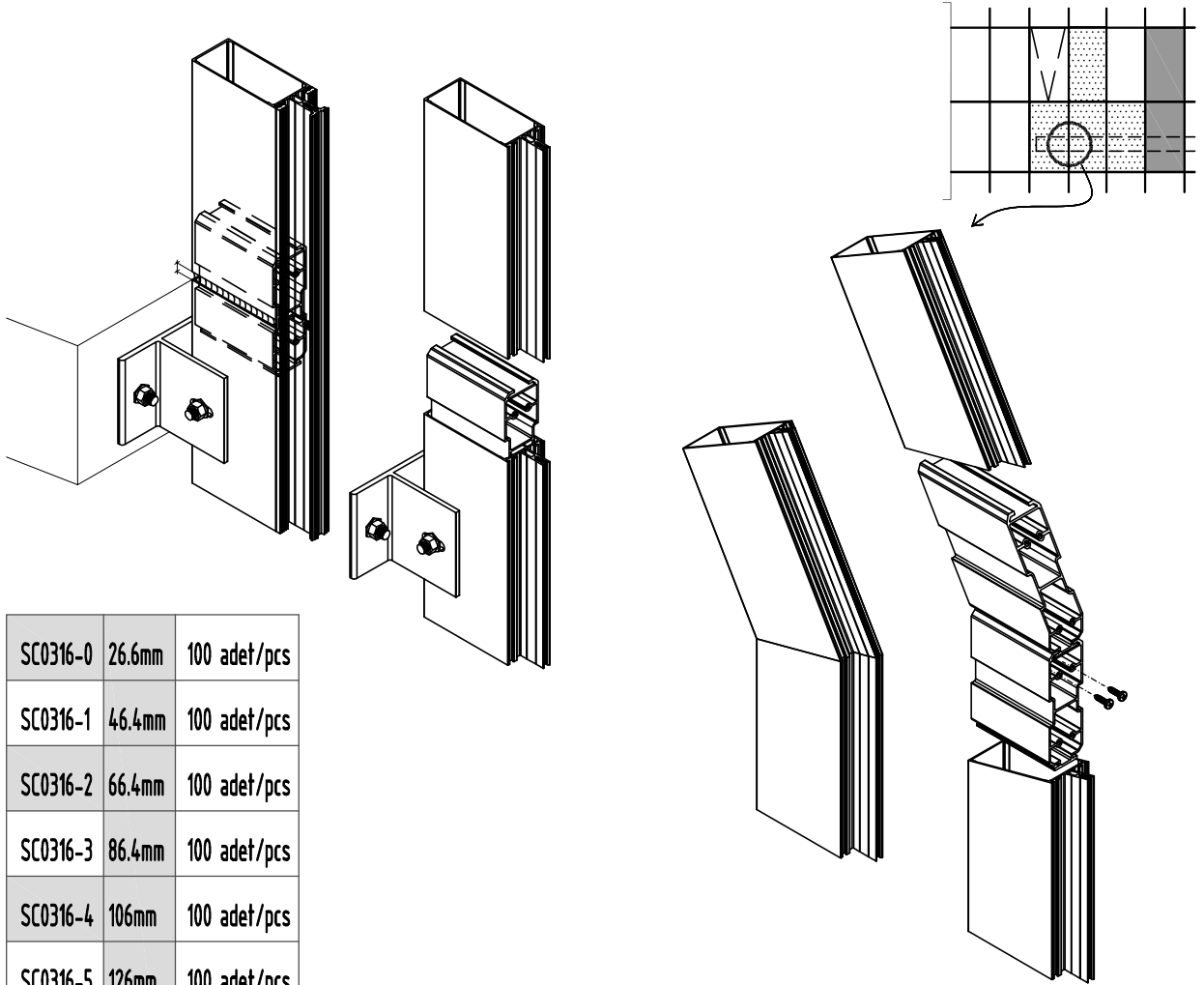

SC0316-0	26.6mm	100 adet/pcs
SC0316-1	46.4mm	100 adet/pcs
SC0316-2	66.4mm	100 adet/pcs
SC0316-3	86.4mm	100 adet/pcs
SC0316-4	106mm	100 adet/pcs
SC0316-5	126mm	100 adet/pcs
SC0316-6	146mm	100 adet/pcs
SC0316-7	166mm	100 adet/pcs
SC0316-8	186mm	100 adet/pcs

Profil No: SC0316

Ağırlık : 3079 gr/m

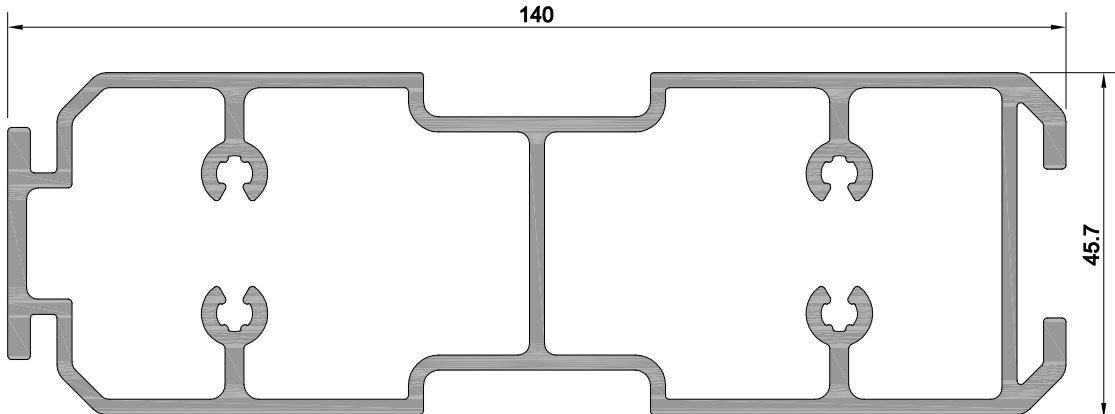

F50 KLASİK SİSTEM ENTEĞRE CEPHE PROFİLLERİ

F50 CLASSIC SYSTEM
INTEGRATED FACADE PROFILE

ÜRÜN TEKNİK ÖZELLİKLERİ
PRODUCT'S TECHNICAL FEATURES

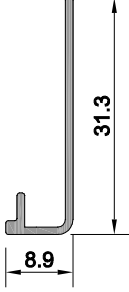

Profil No: SC0346

Ağırlık : 120 gr/m

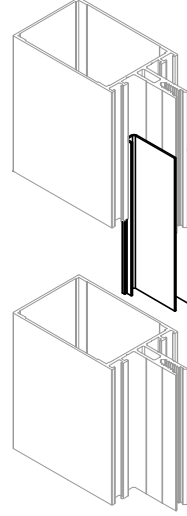
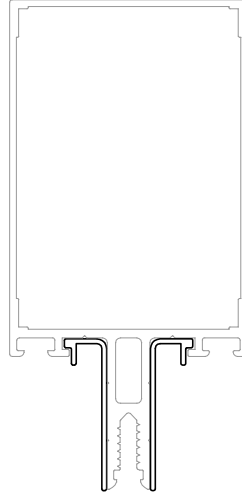
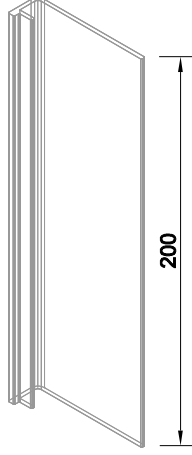

F50 KLASİK SİSTEM

ENTEĞRE CEPHE

F50 CLASSIC SYSTEM
INTEGRADET FACADE

YAN BİTİM - SABİT
WALL CONNECTION-FIXED

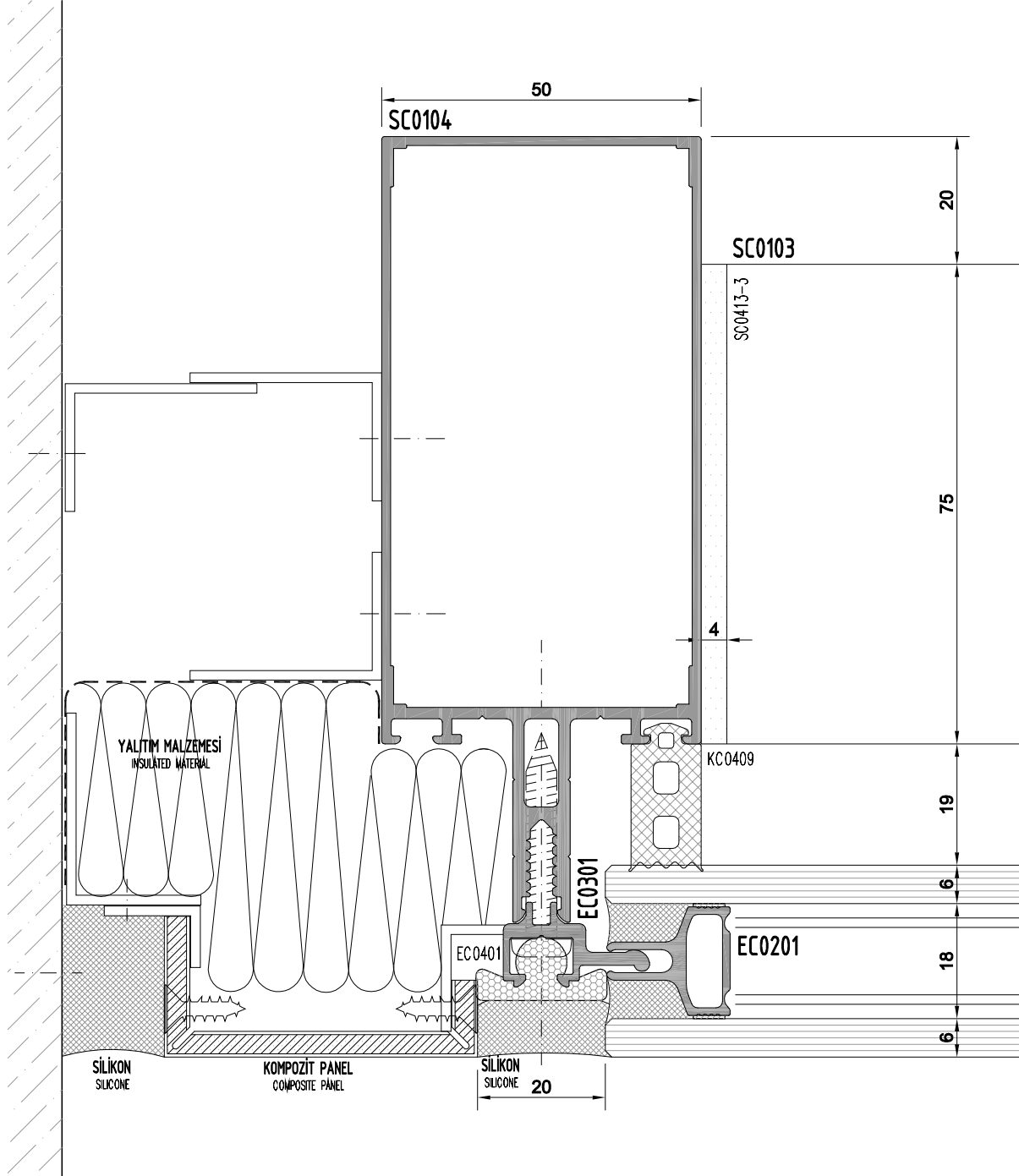
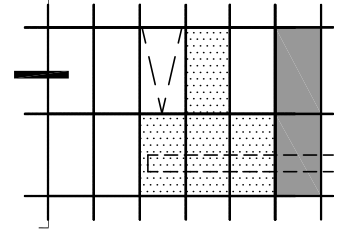

F50 KLASİK SİSTEM
ENTEĞRE CEPHE
F50 CLASSIC SYSTEM
INTEGRADET FACADE

SABİT - SABİT
FIXED-FIXED

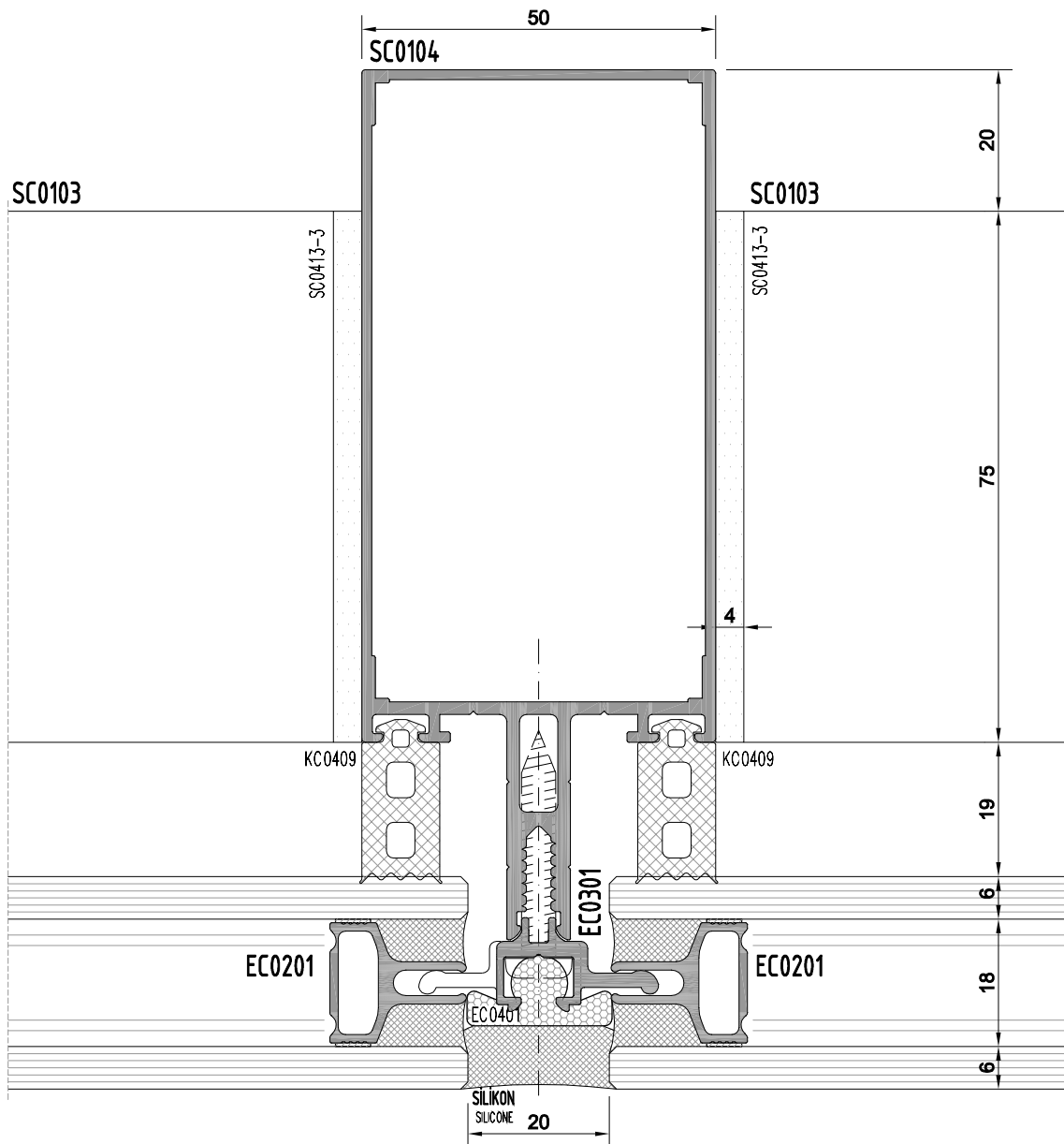
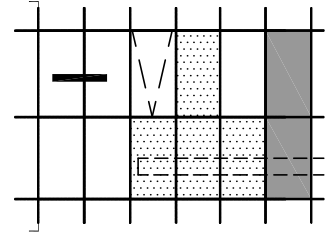

F50 KLASİK SİSTEM
ENTEĞRE CEPHE
F50 CLASSIC SYSTEM
INTEGRADET FACADE

SABİT - SABİT
FIXED-FIXED

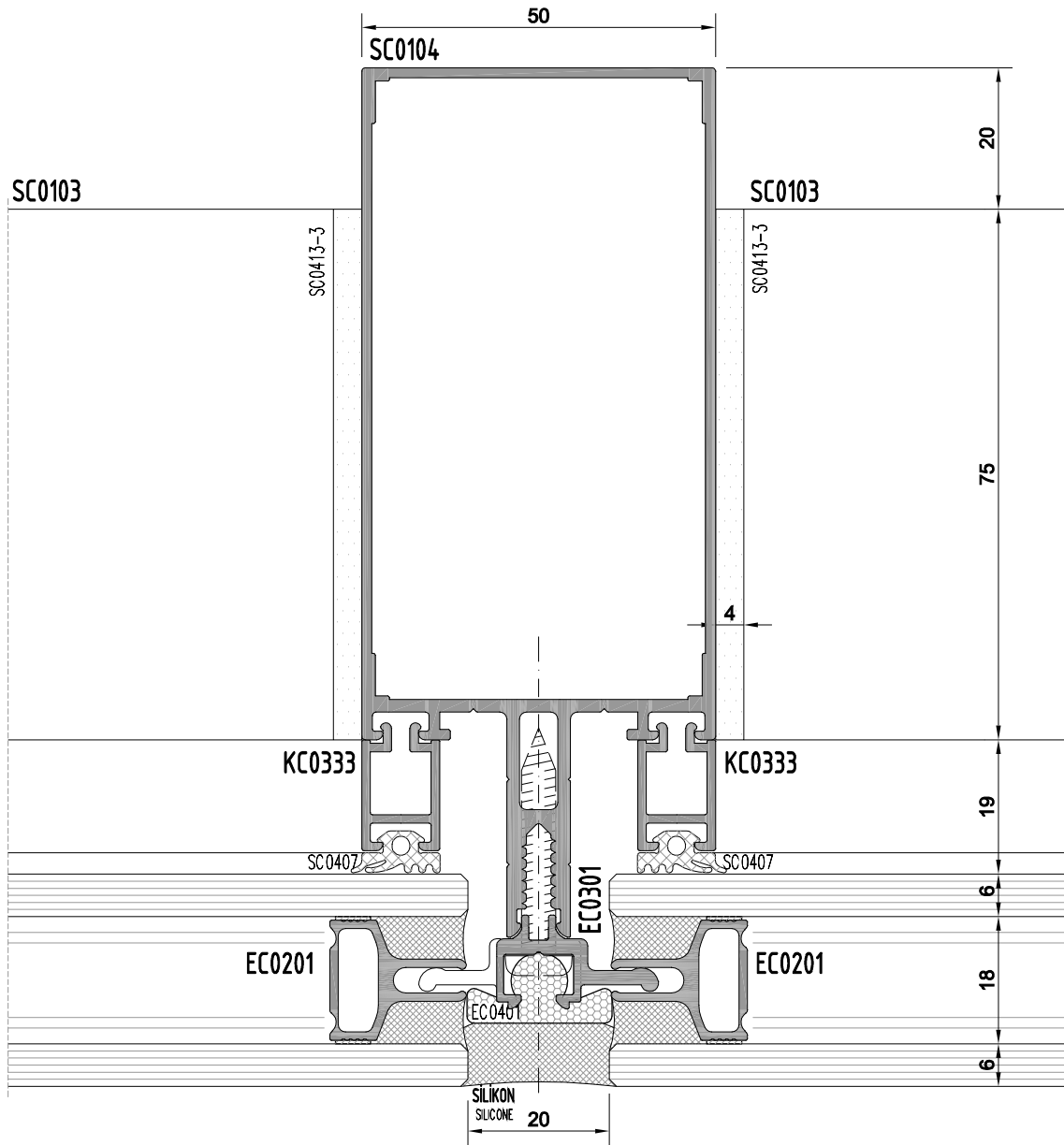
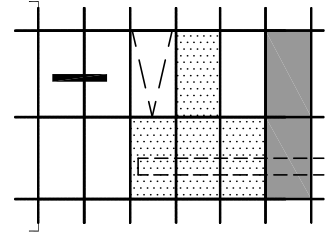

F50 KLASİK SİSTEM
ENTEĞRE CEPHE
F50 CLASSIC SYSTEM
INTEGRADET FAÇADE

SABİT - SABİT
FIXED-FIXED

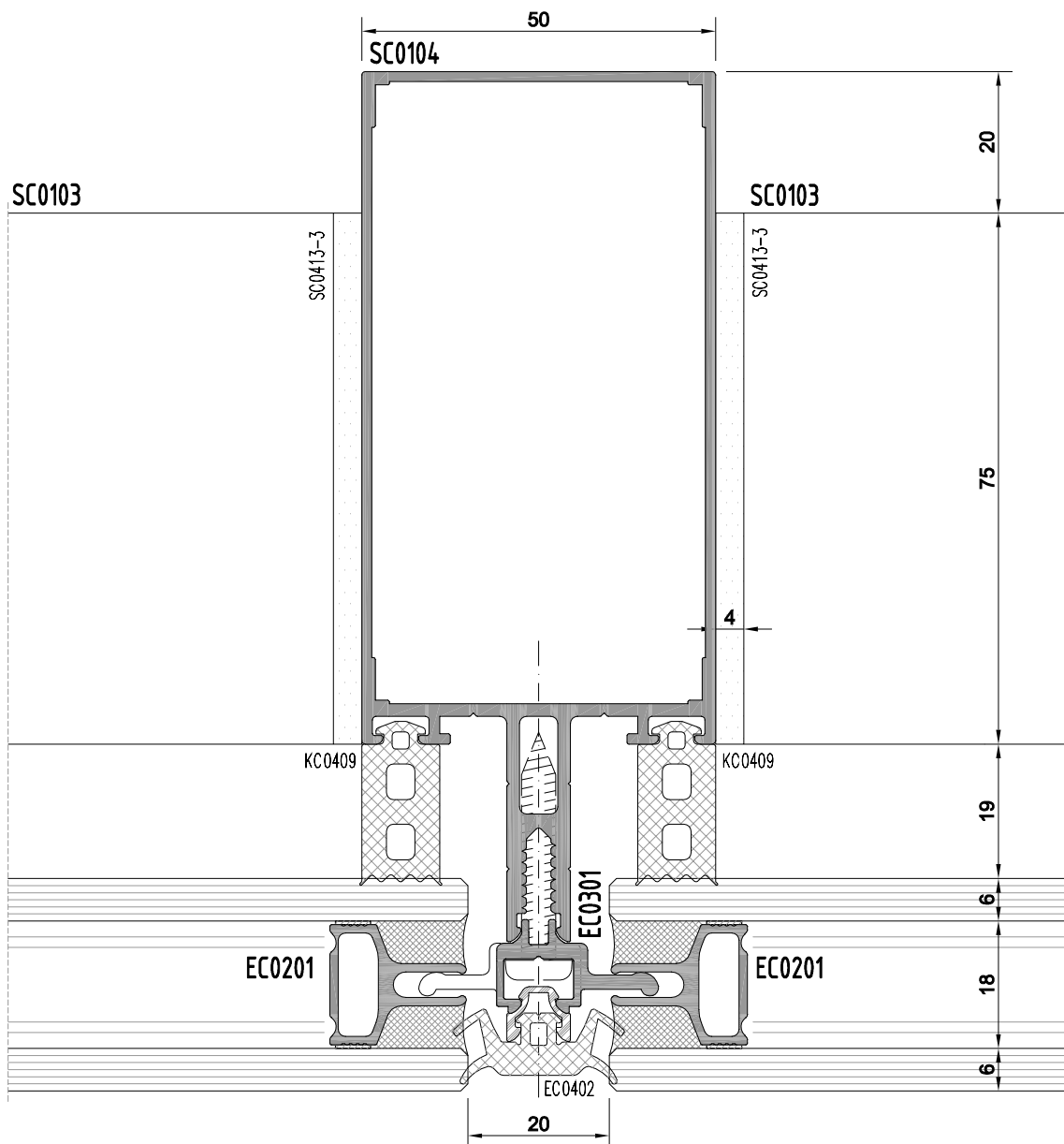
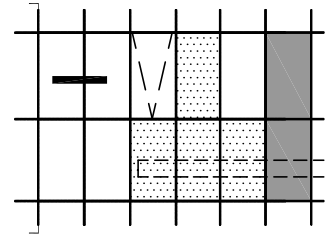

F50 KLASİK SİSTEM

ENTEĞRE CEPHE

F50 CLASSIC SYSTEM
INTEĞRADET FAÇADE

SABİT - KANAT
FIXED-SASH

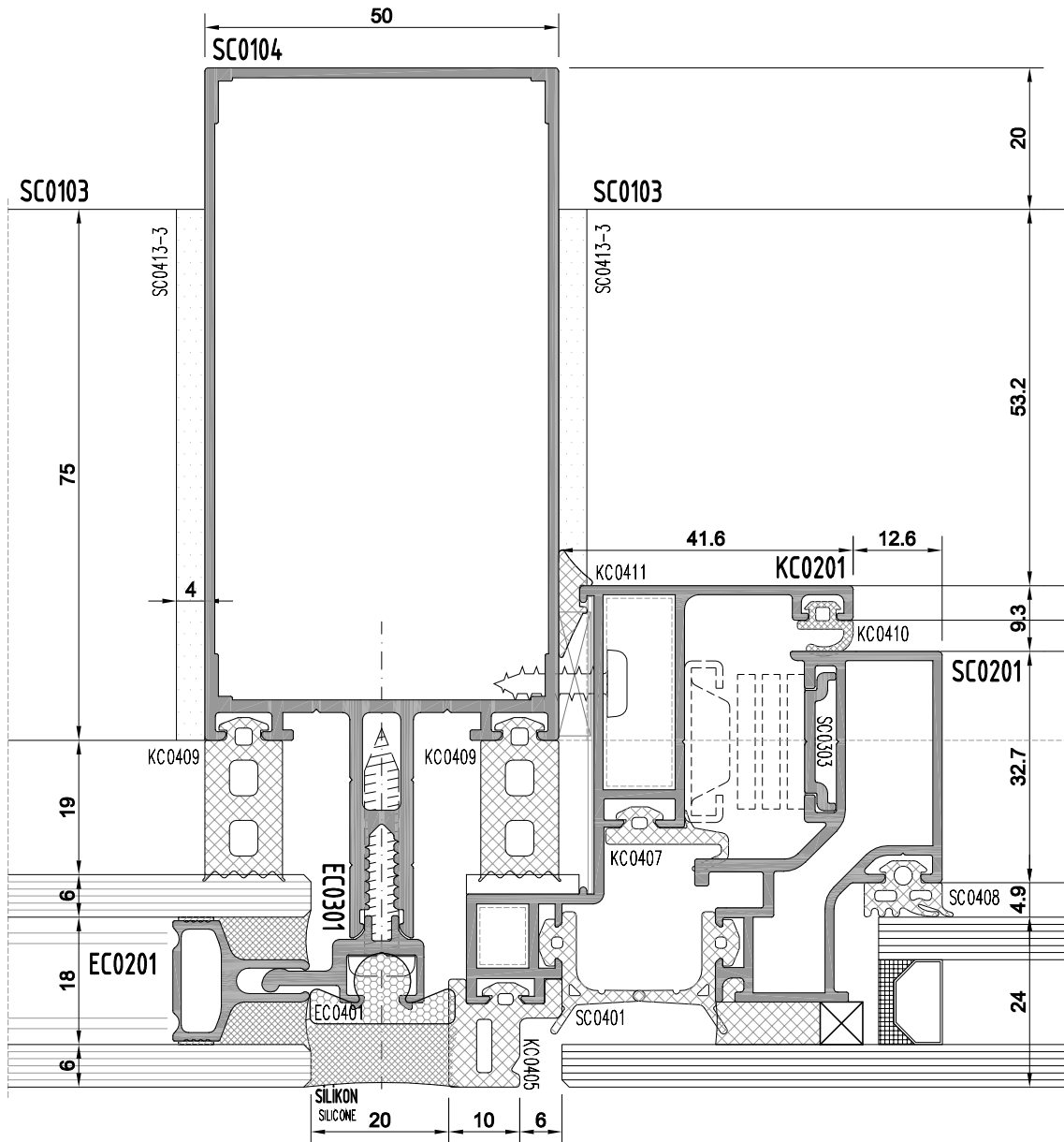
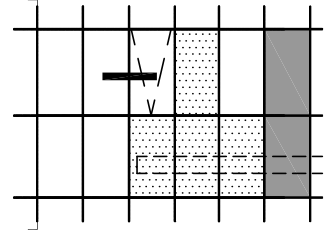

F50 KLASİK SİSTEM
ENTEĞRE CEPHE
F50 CLASSIC SYSTEM
İNTEĞRAĐET FAÇADE

KANAT - SPANĐREL
SASH-SPANĐREL

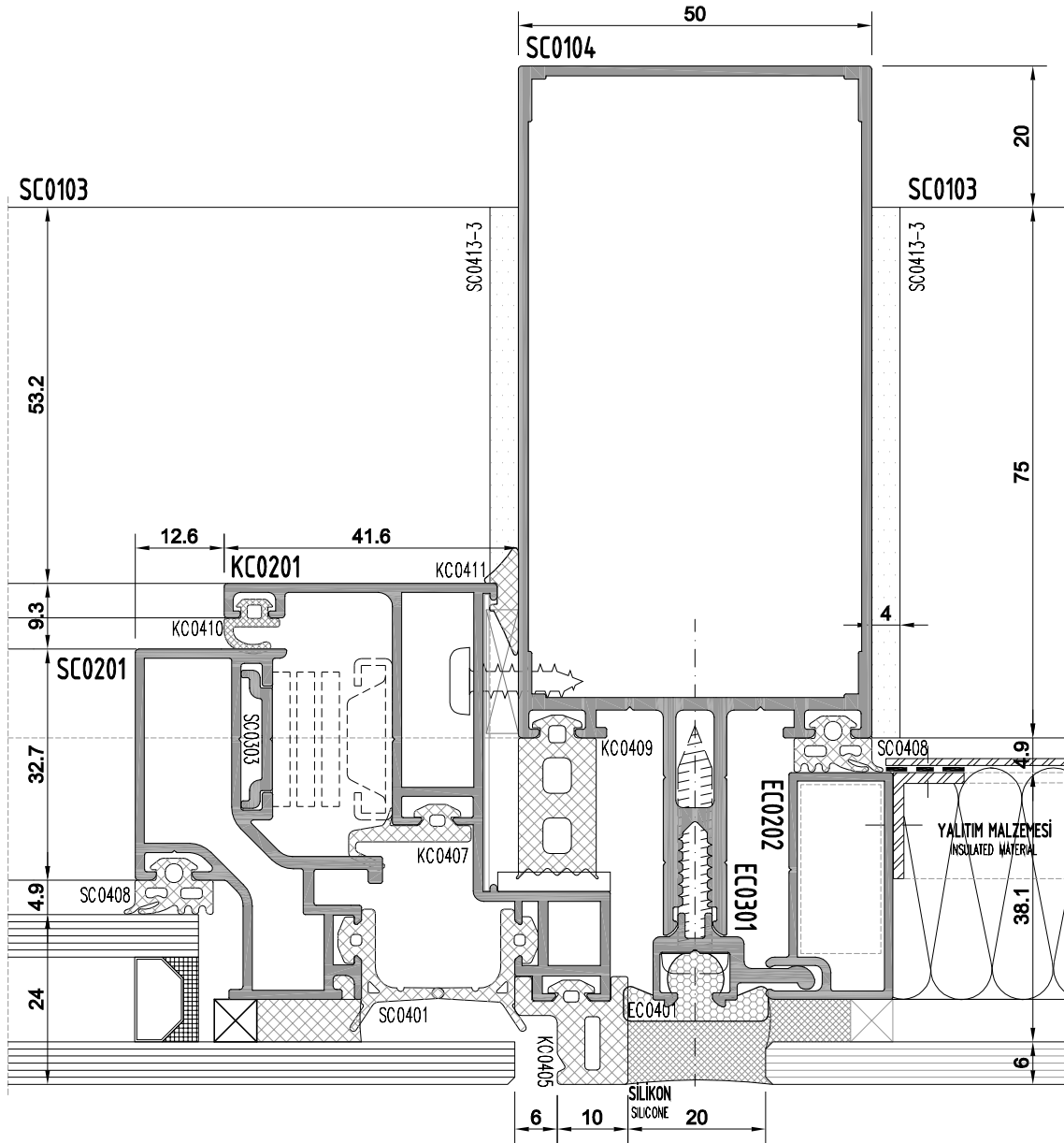
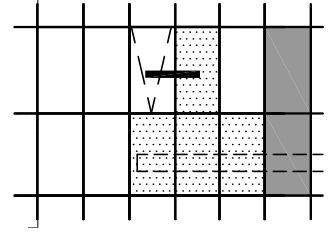

F50 KLASİK SİSTEM
ENTEĞRE CEPHE
F50 CLASSIC SYSTEM
İNTEĞRADET FAÇADE

SABİT - KANAT
FIXED-SASH

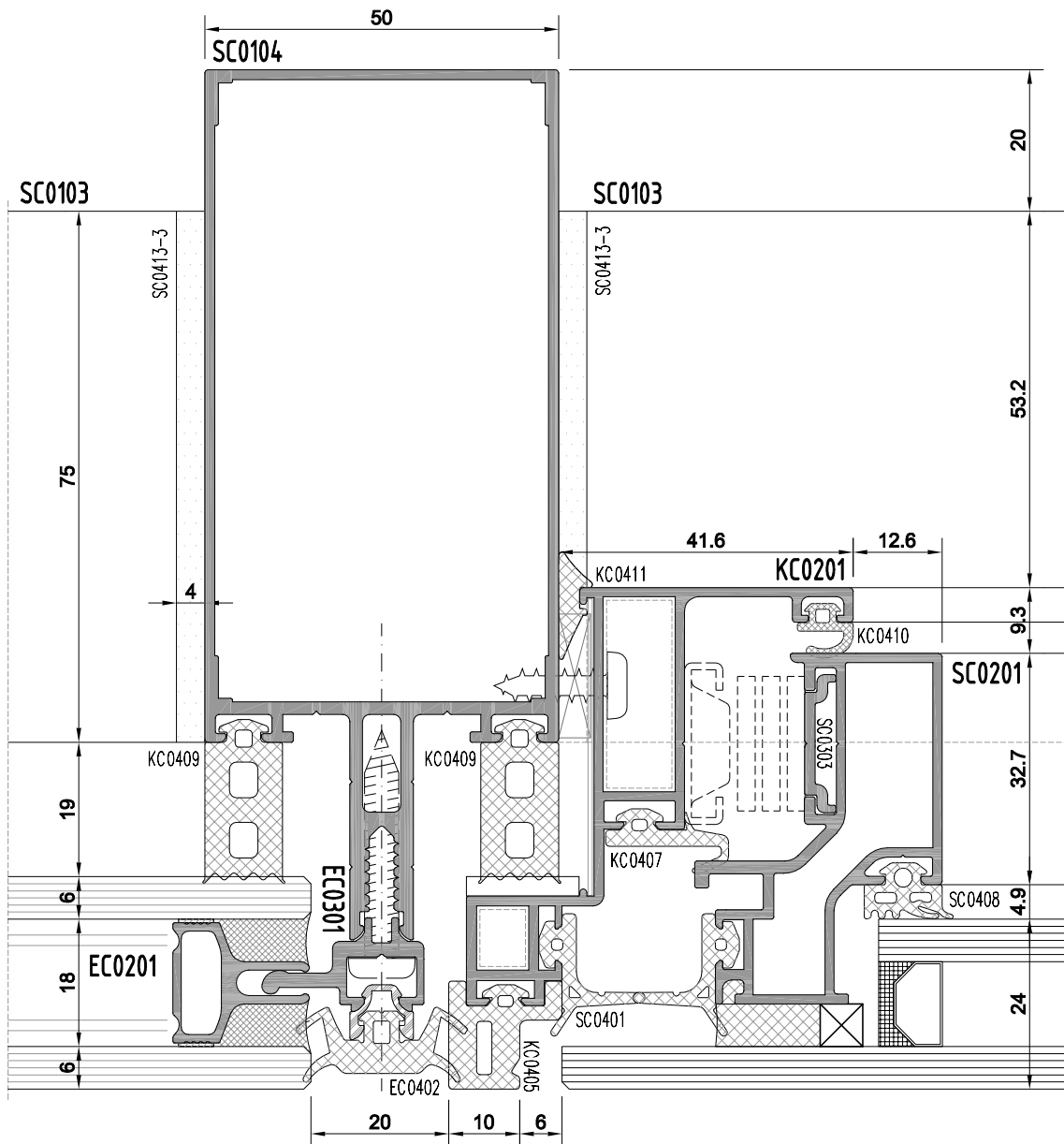
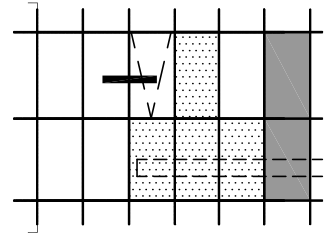

F50 KLASİK SİSTEM
ENTEĞRE CEPHE
F50 CLASSIC SYSTEM
INTEGRADET FACADE

SABIT - KANAT
FIXED-SASH

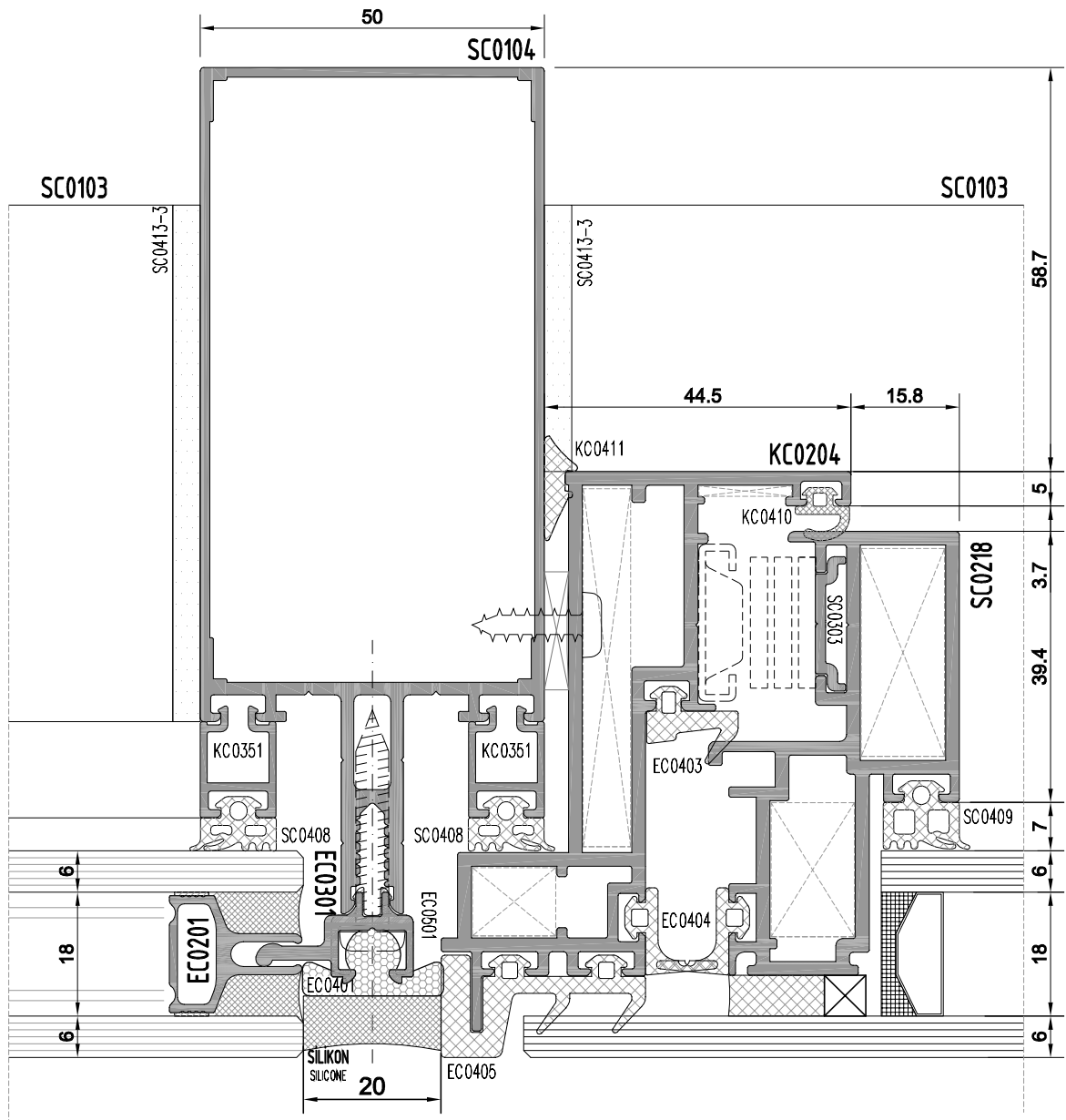
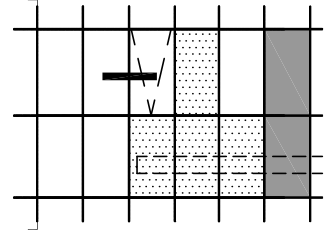

F50 KLASİK SİSTEM
ENTEĞRE CEPHE
F50 CLASSIC SYSTEM
İNTEĞRADET FAÇADE

SABİT - KANAT
FIXED-SASH

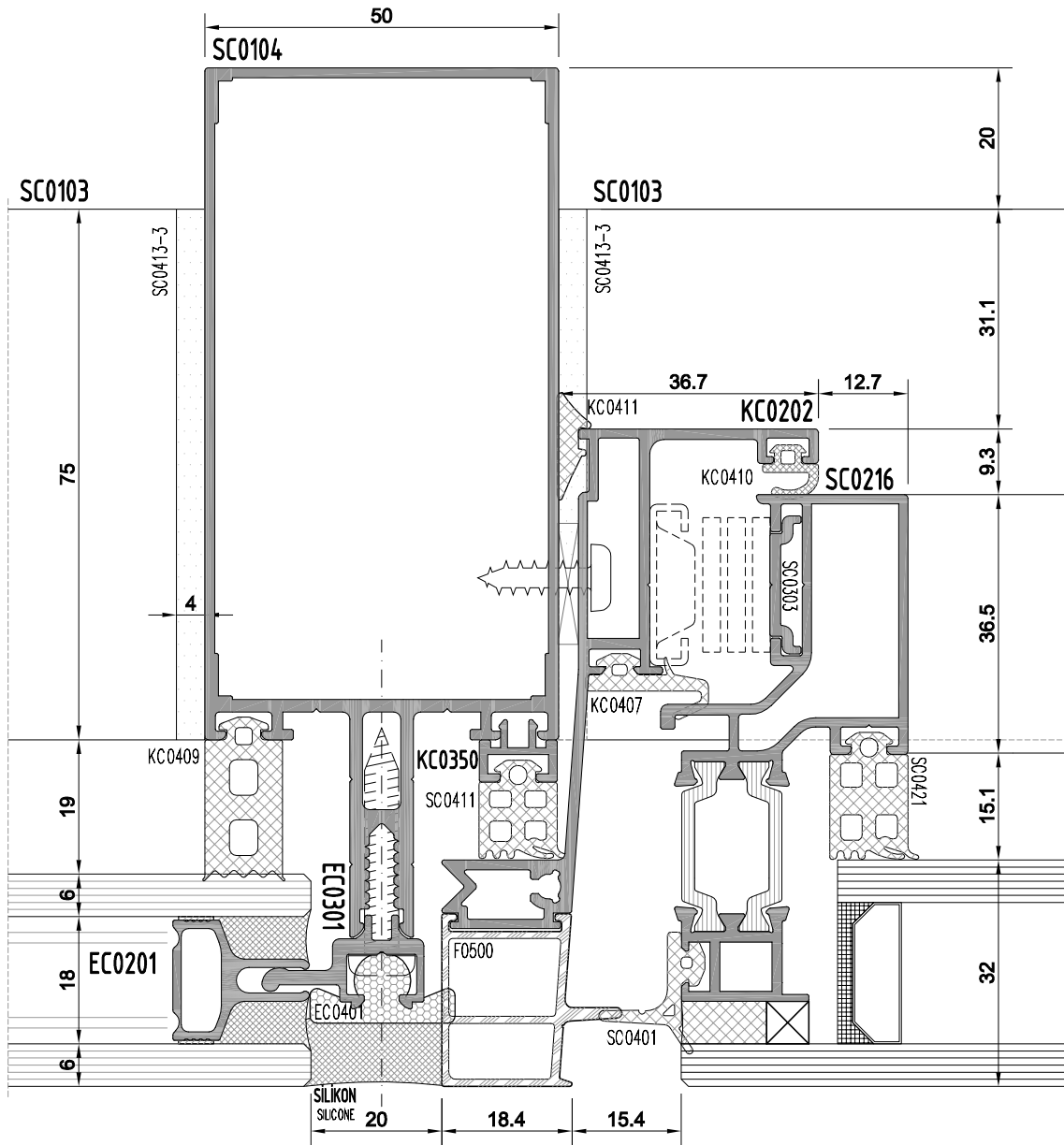
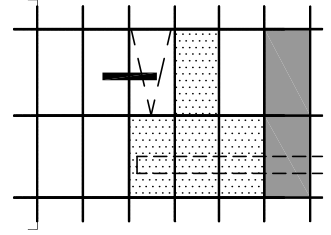

F50 KLASİK SİSTEM
ENTEĞRE CEPHE
F50 CLASSIC SYSTEM
İNTEĞRADET FACADE

SPANDREL - KANAT
SPANDREL - SASH

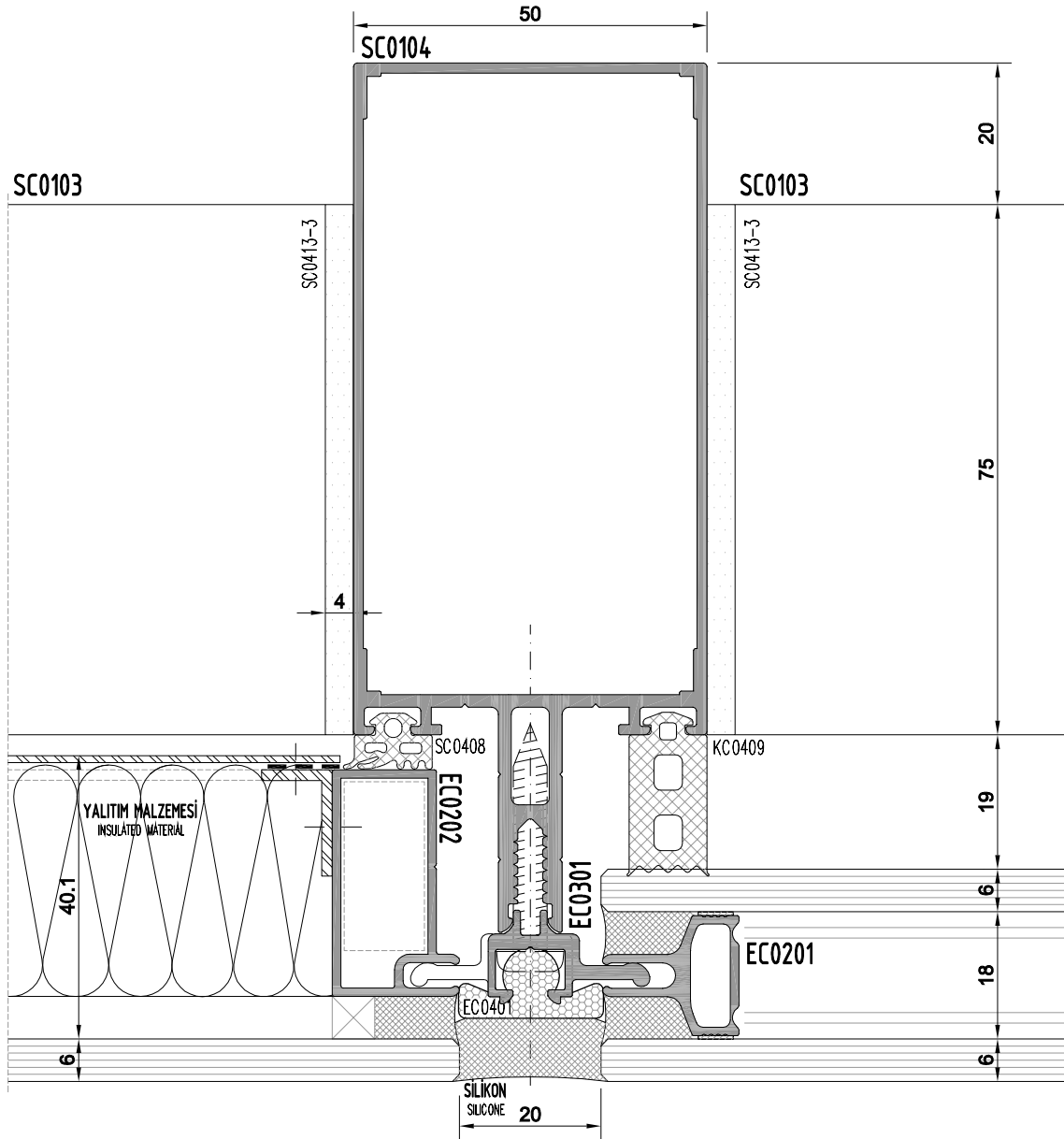
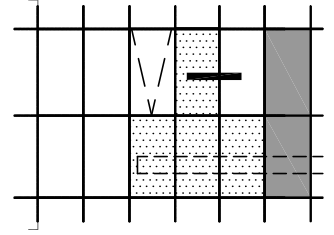

F50 KLASİK SİSTEM

ENTEĞRE CEPHE

F50 CLASSIC SYSTEM
İNTEĞRADET FAÇADE

SABİT - KOMPOZİT

FIXED-COMPOSITE

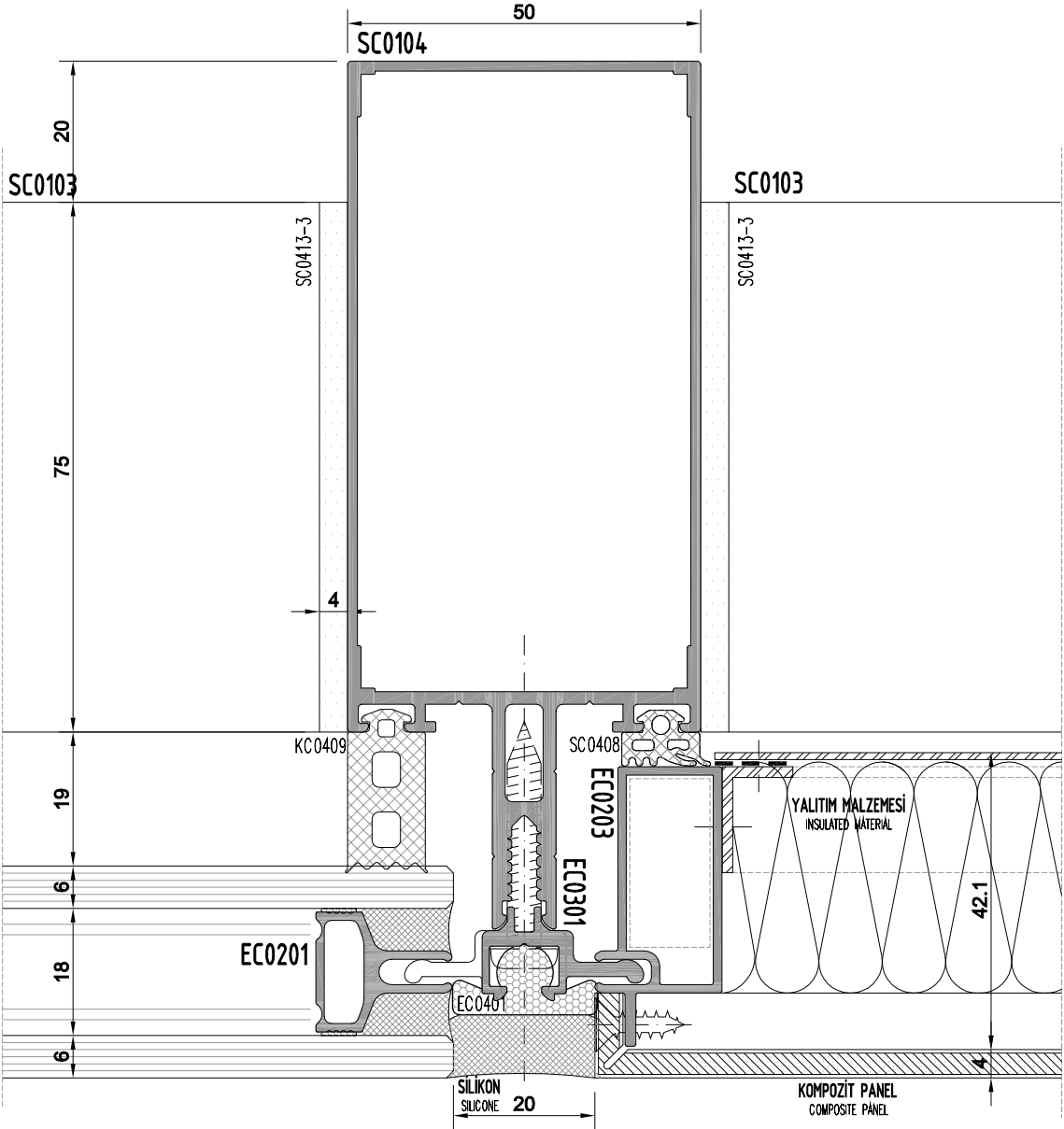
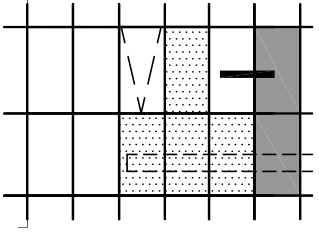

F50 KLASİK SİSTEM
ENTEĞRE CEPHE
F50 CLASSIC SYSTEM
İNTEĞRADET FACADE

SABİT - SABİT
FIXED-FIXED

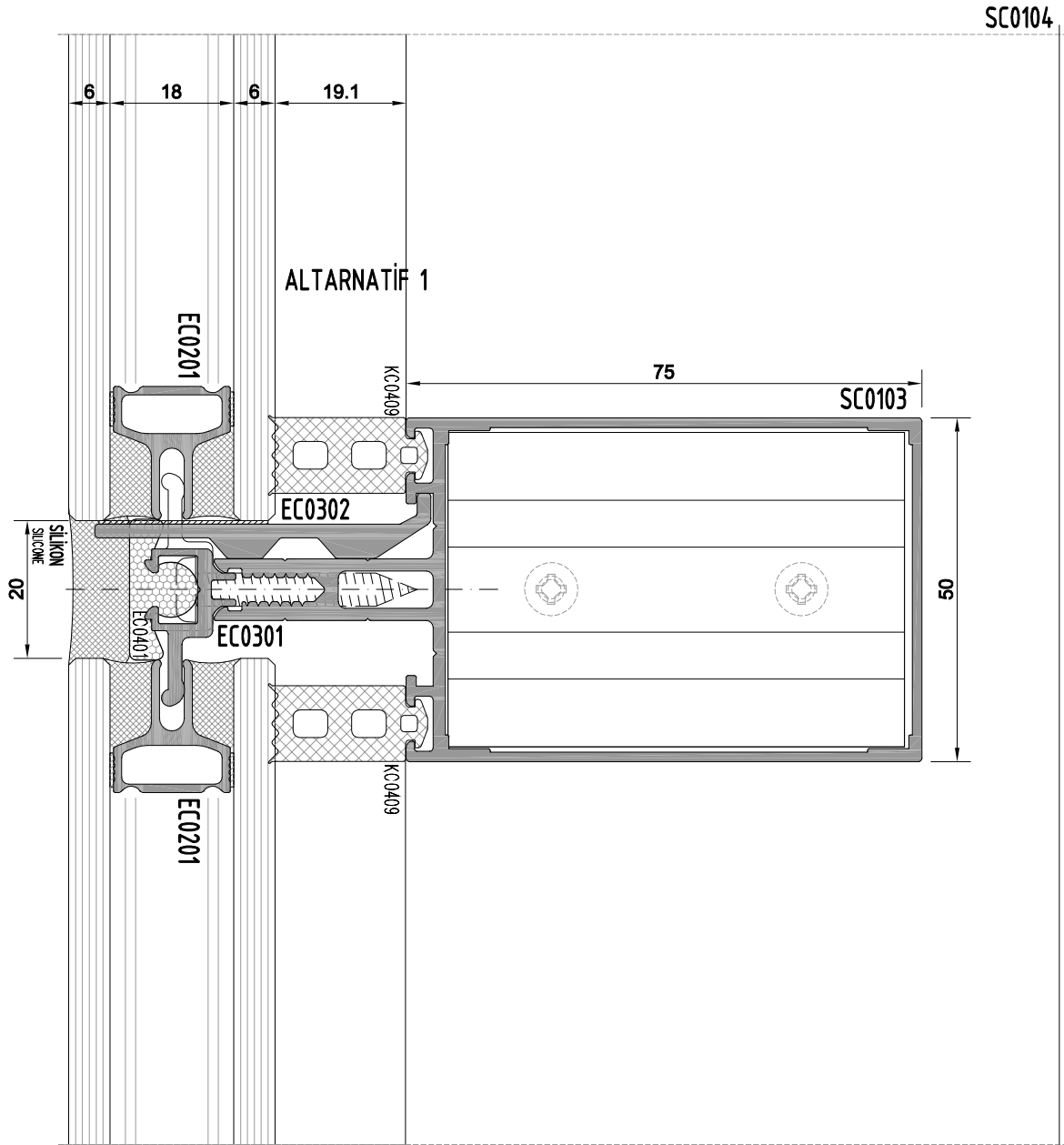
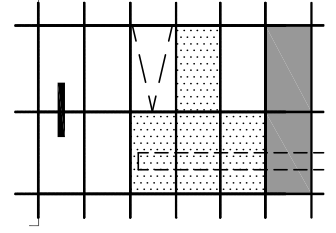

F50 KLASİK SİSTEM
ENTEĞRE CEPHE
F50 CLASSIC SYSTEM
İNTEĞRADET FAÇADE

SABİT - SABİT
FIXED-FIXED

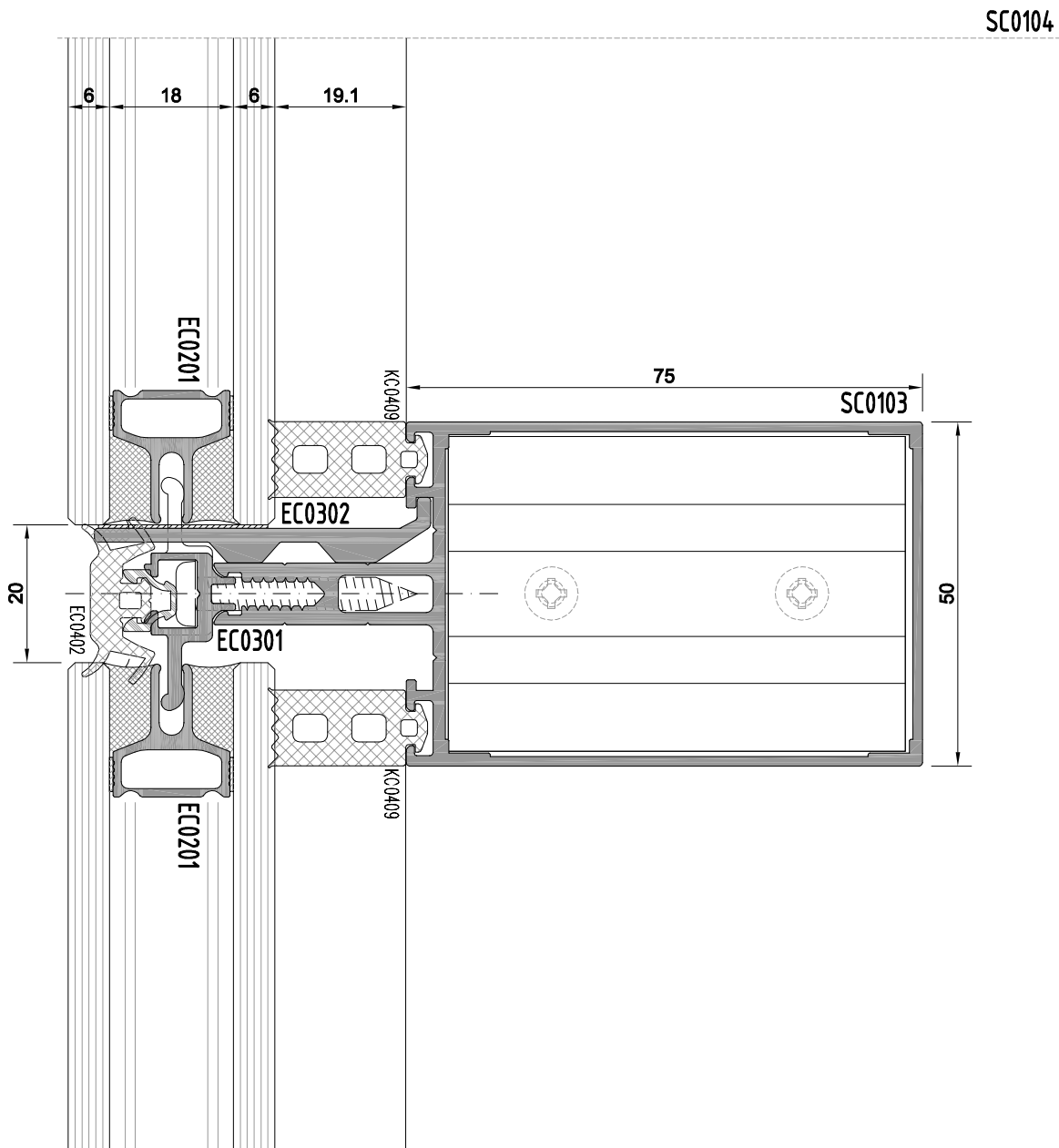
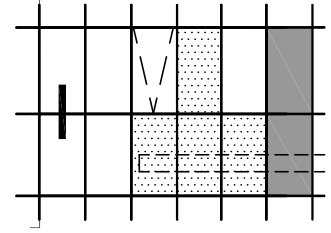

F50 KLASİK SİSTEM
ENTEĞRE CEPHE
F50 CLASSIC SYSTEM
INTEGRADET FACADE

KANAT - SPANDEL
SASH-SPANDEL

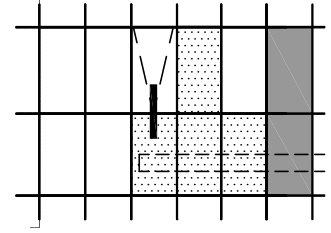

SC0104

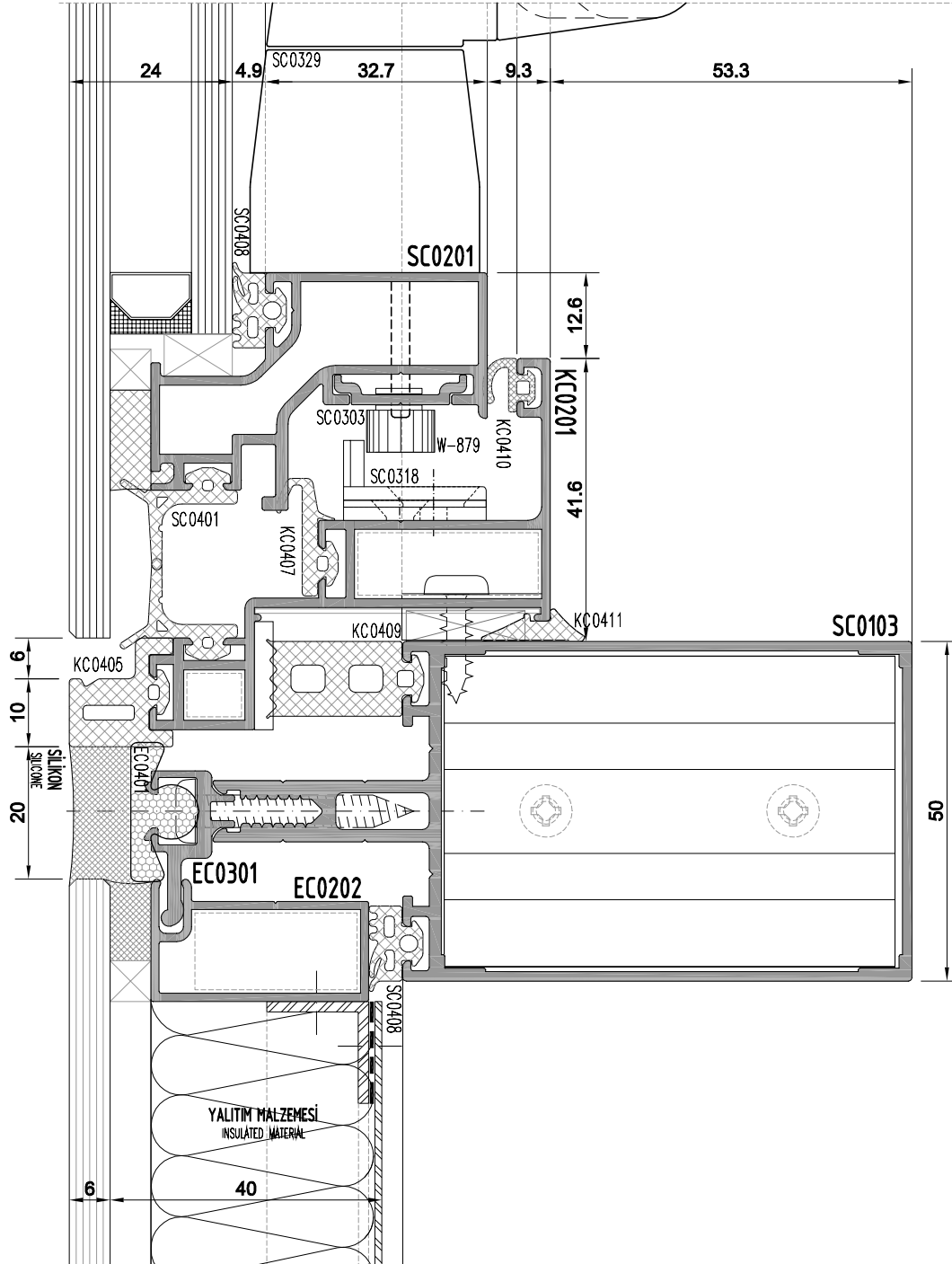

F50 KLASİK SİSTEM
ENTEĞRE CEPHE
F50 CLASSIC SYSTEM
INTEGRADET FACADE

KANAT - SPANDEL
SASH-SPANDEL

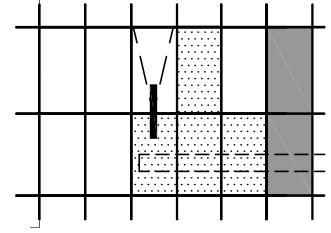

SC0104

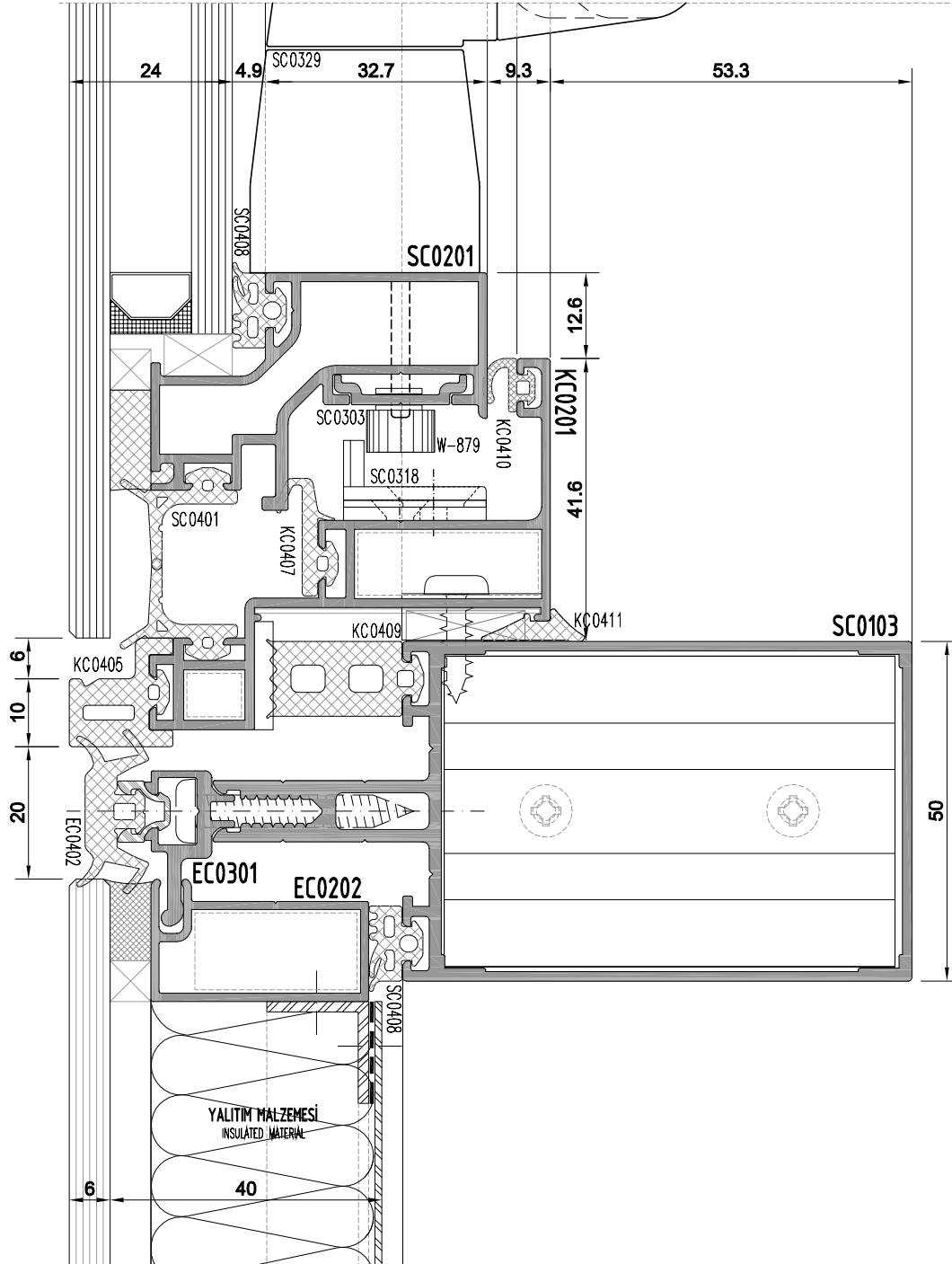

F50 KLASİK SİSTEM
ENTEĞRE CEPHE
F50 CLASSIC SYSTEM
INTEĞRADET FAÇADE

KANAT - SPANDREL
SASH-SPANDREL

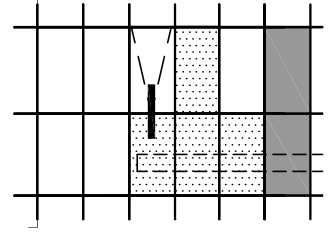

SC0104

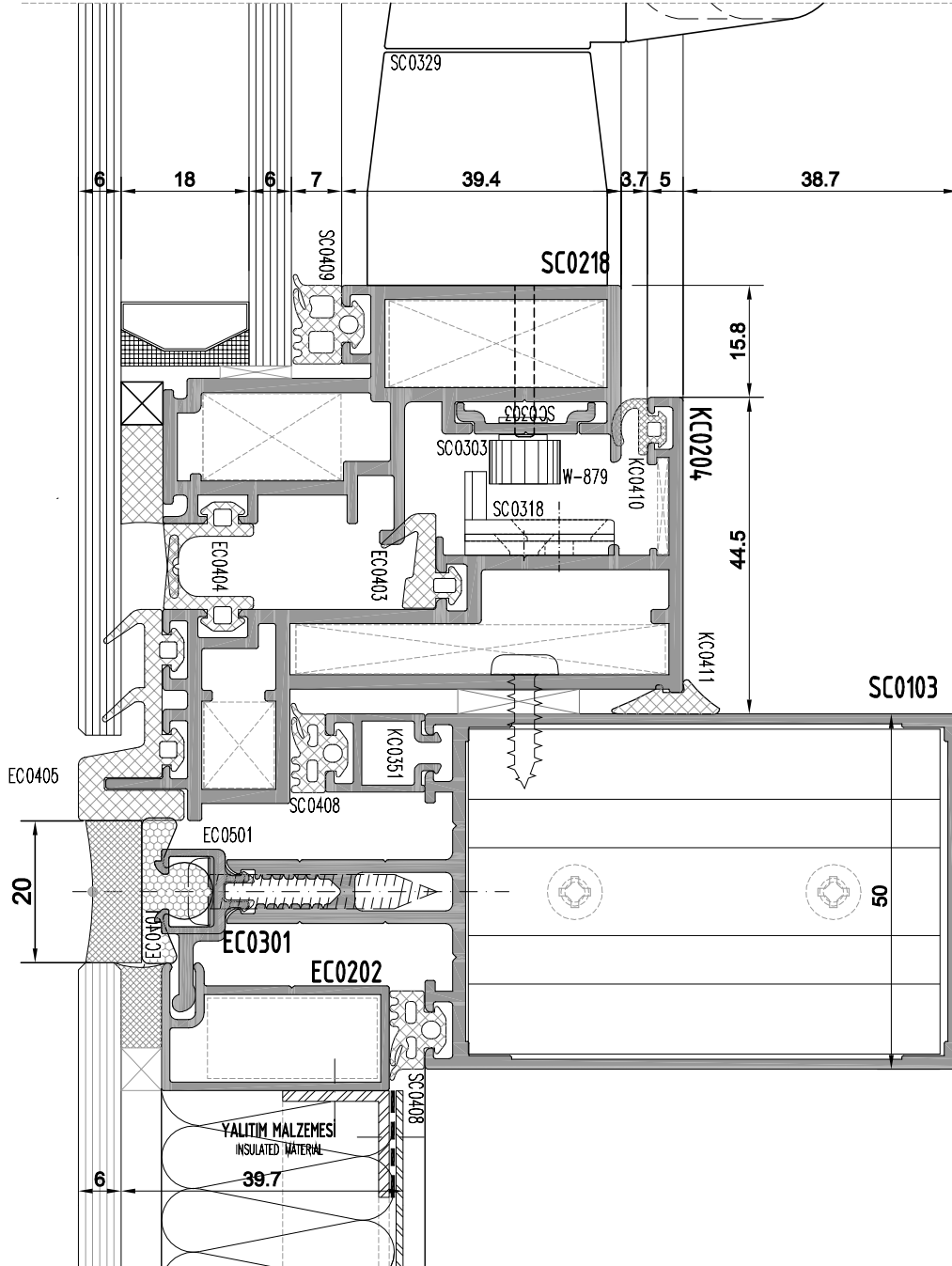

F50 KLASİK SİSTEM
ENTEĞRE CEPHE
F50 CLASSIC SYSTEM
INTEĞRADET FACADE

KANAT - SPANDREL
SASH-SPANDREL

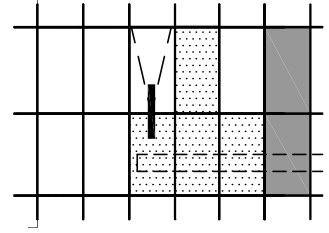

SC0104

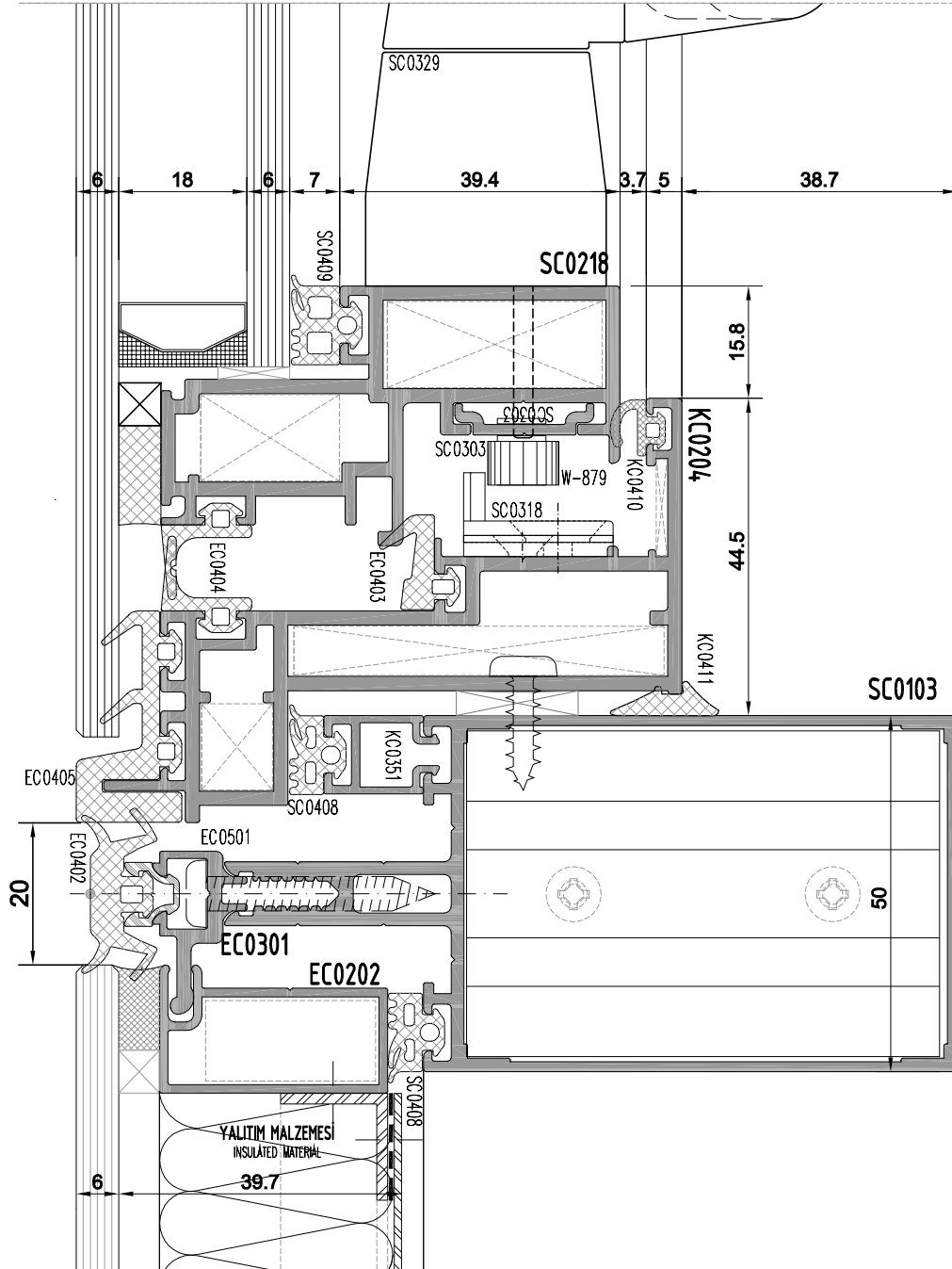

F50 KLASİK SİSTEM
ENTEĞRE CEPHE
F50 CLASSIC SYSTEM
İNTEĞRADET FAÇADE

SPANDREL - SPANDREL
SPANDREL-SPANDREL

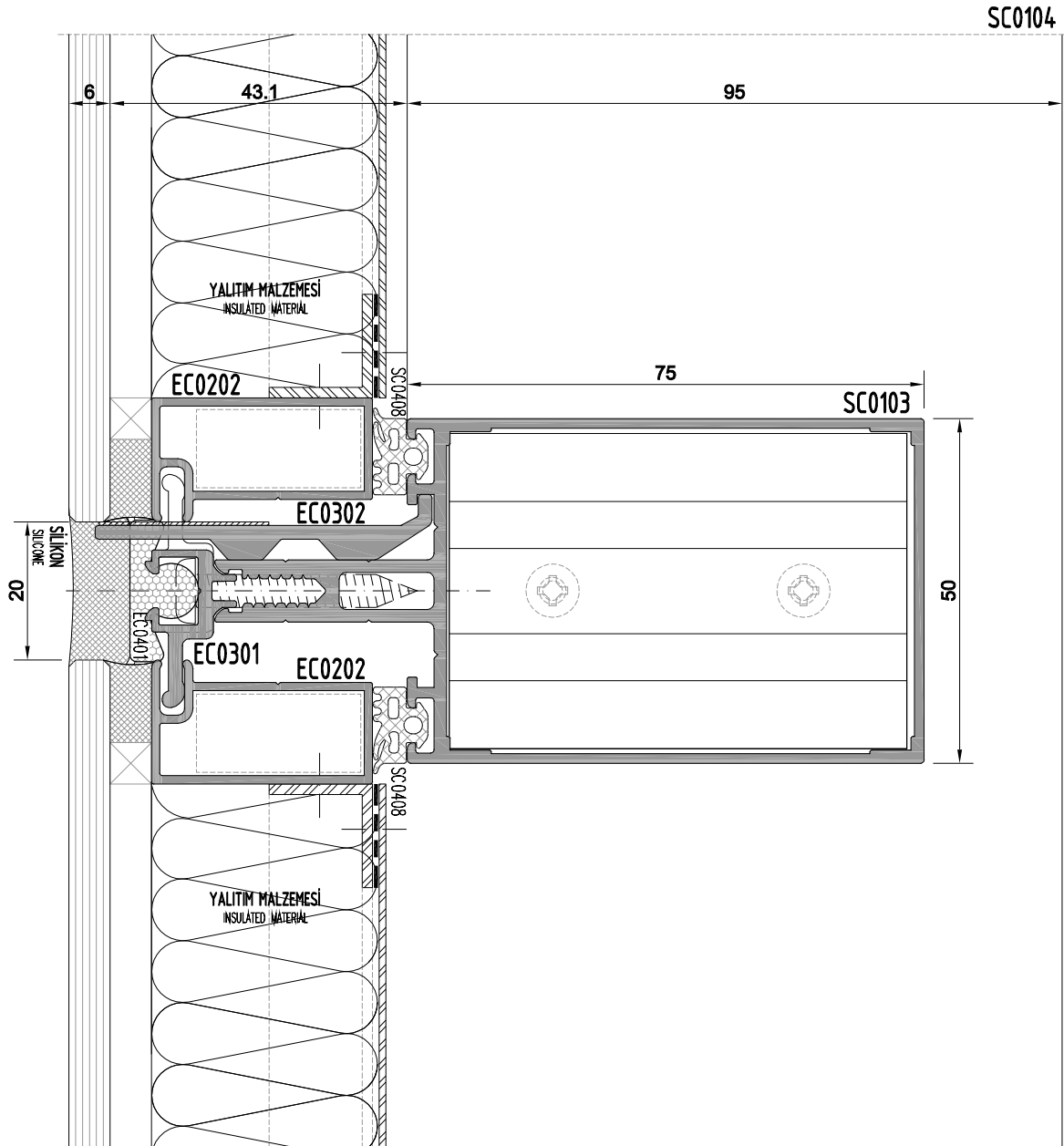
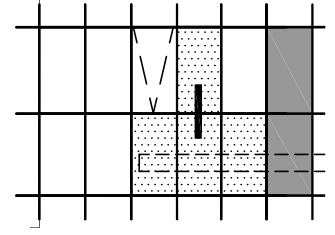

F50 KLASİK SİSTEM
ENTEĞRE CEPHE
F50 CLASSIC SYSTEM
İNTEĞRADET FAÇADE

SABİT - SPANDEL
FIXED-SPANDEL

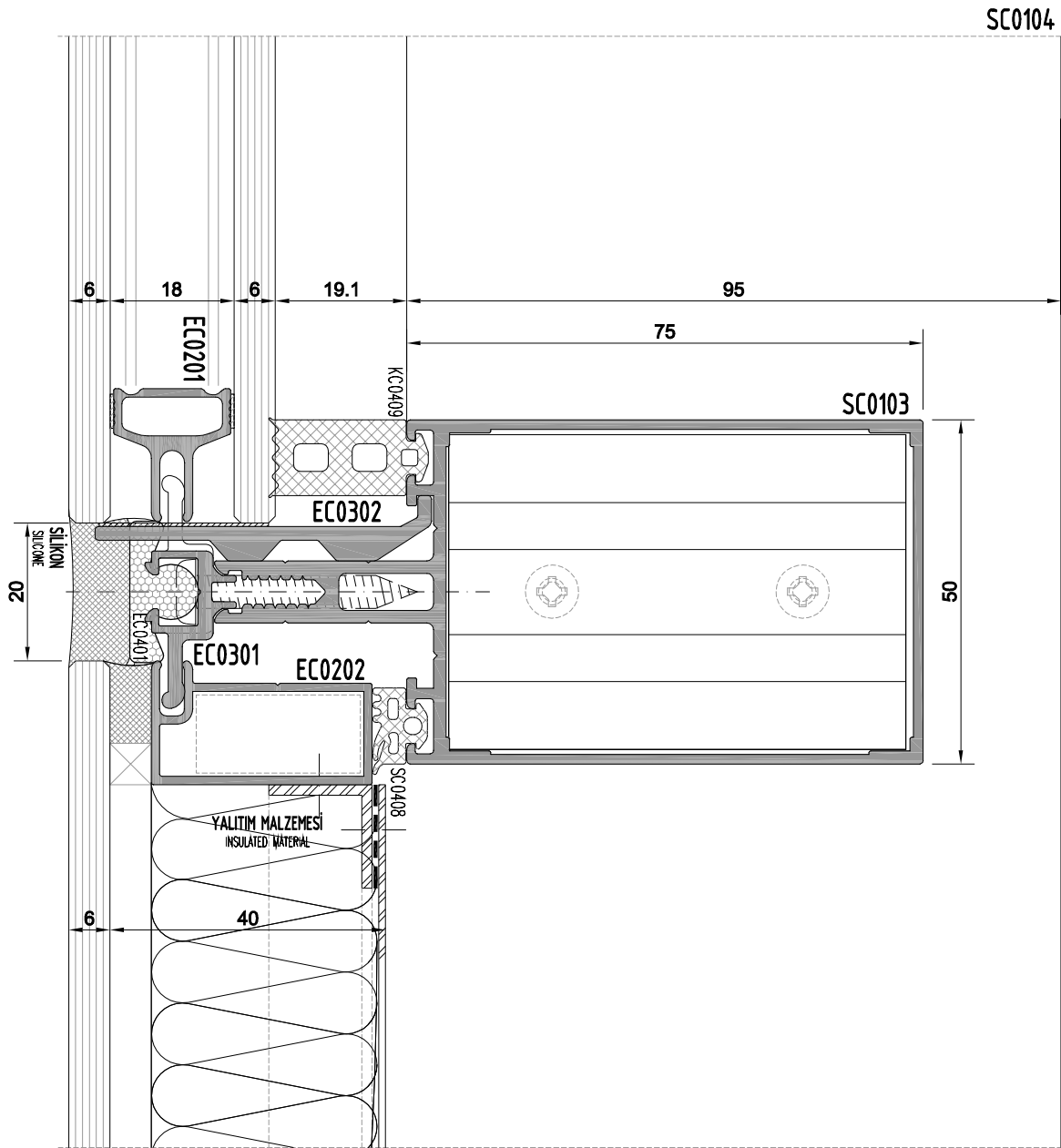
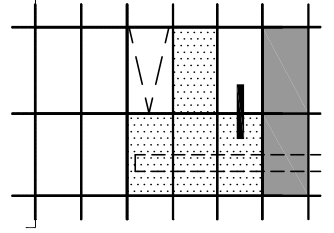

F50 KLASİK SİSTEM
ENTEĞRE CEPHE
F50 CLASSIC SYSTEM
İNTEĞRADET FAÇADE

KOMPOZİT - KOMPOZİT
COMPOSITE-COMPOSITE

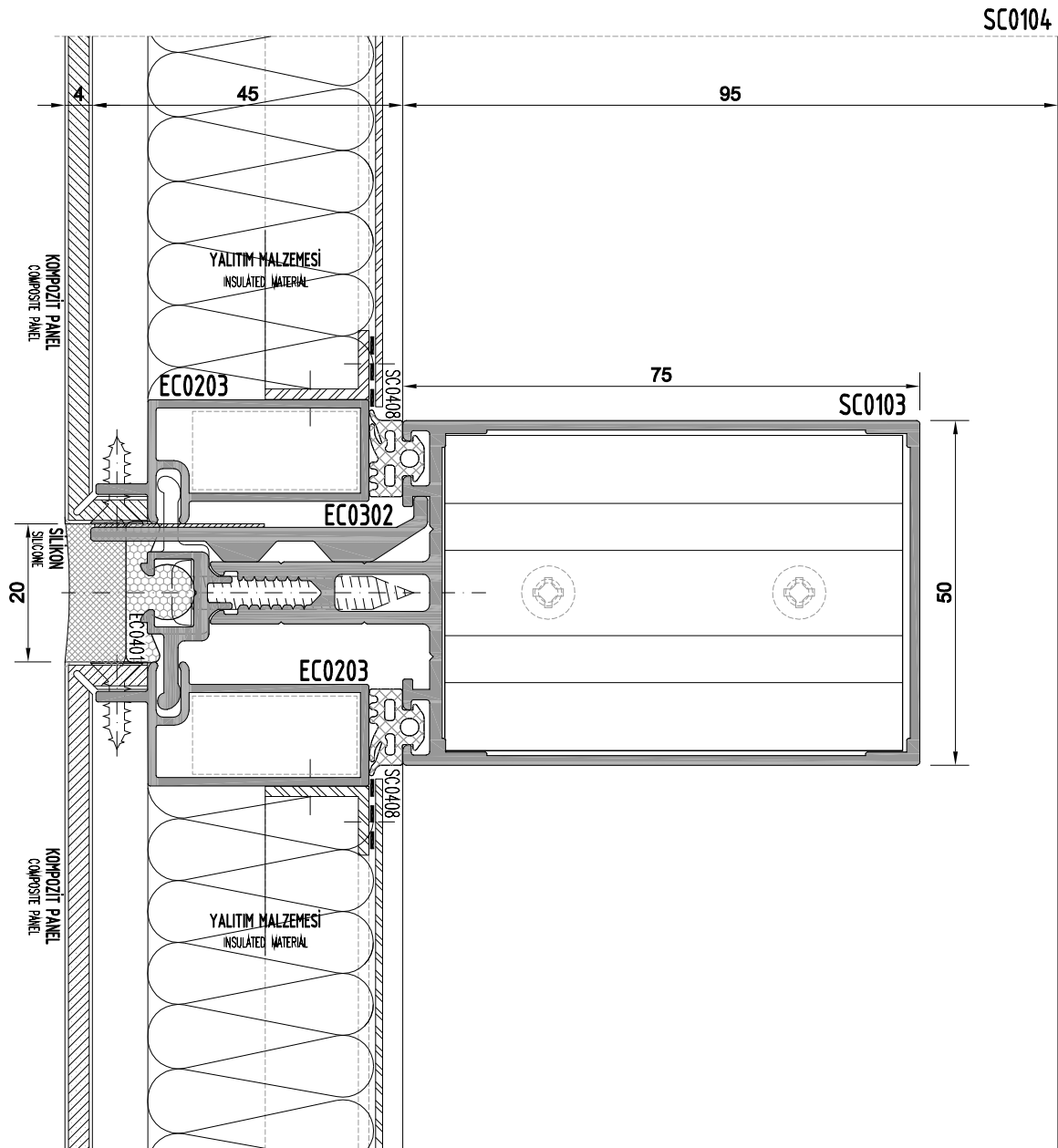
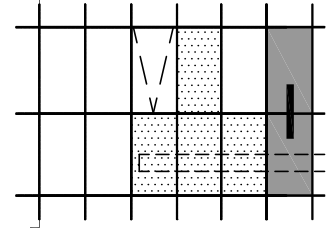

F50 KLASİK SİSTEM
ENTEĞRE CEPHE
F50 CLASSIC SYSTEM
İNTEĞRADET FAÇADE

KÖŞE DETAY
CORNER DETAIL

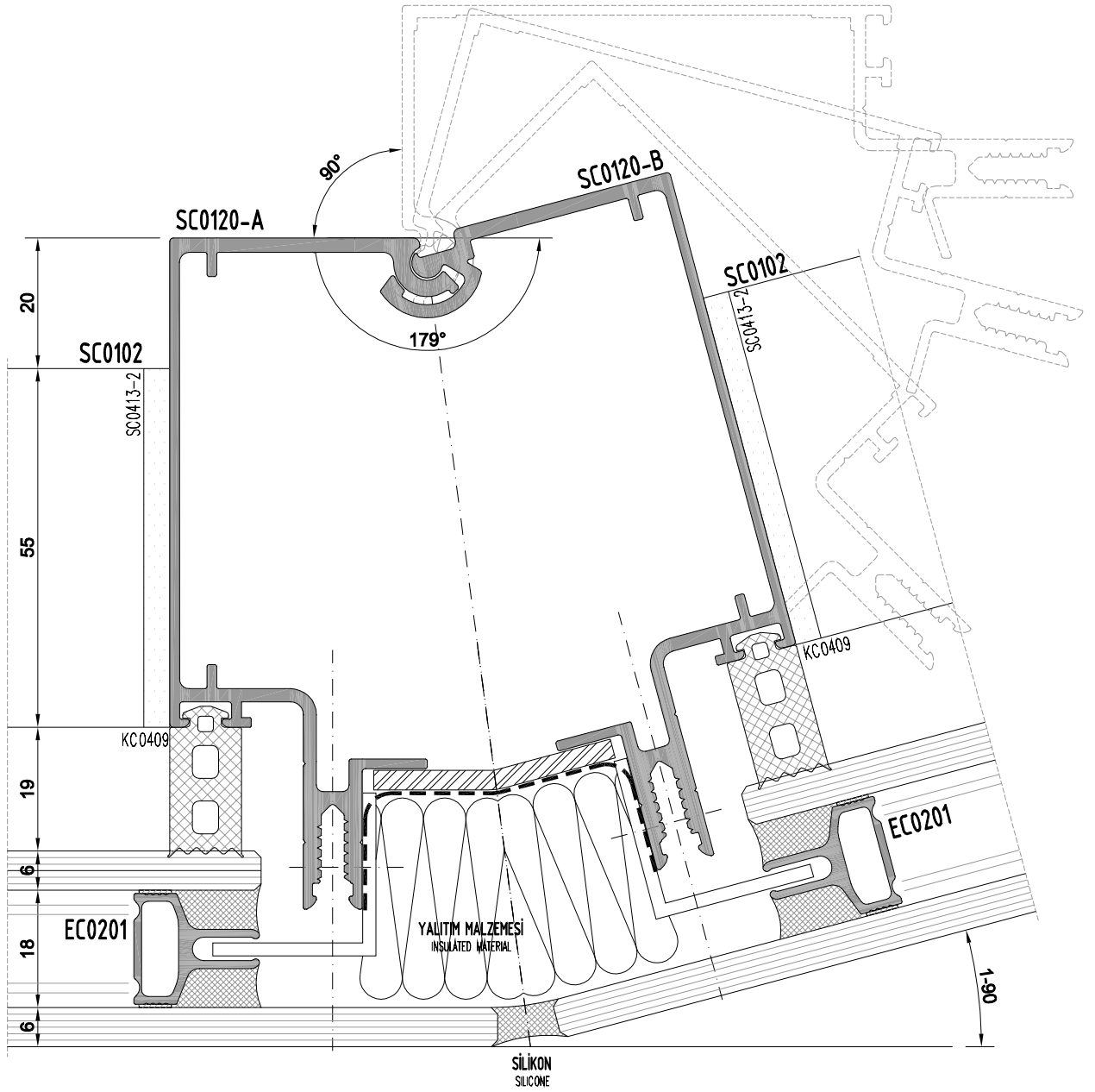
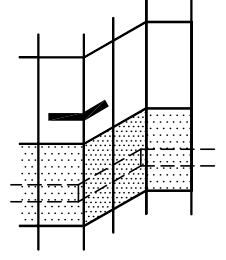

F50 KLASİK SİSTEM
ENTEĞRE CEPHE
F50 CLASSIC SYSTEM
İNTEĞRADET FAÇADE

KÖŞE DETAY
CORNER DETAIL

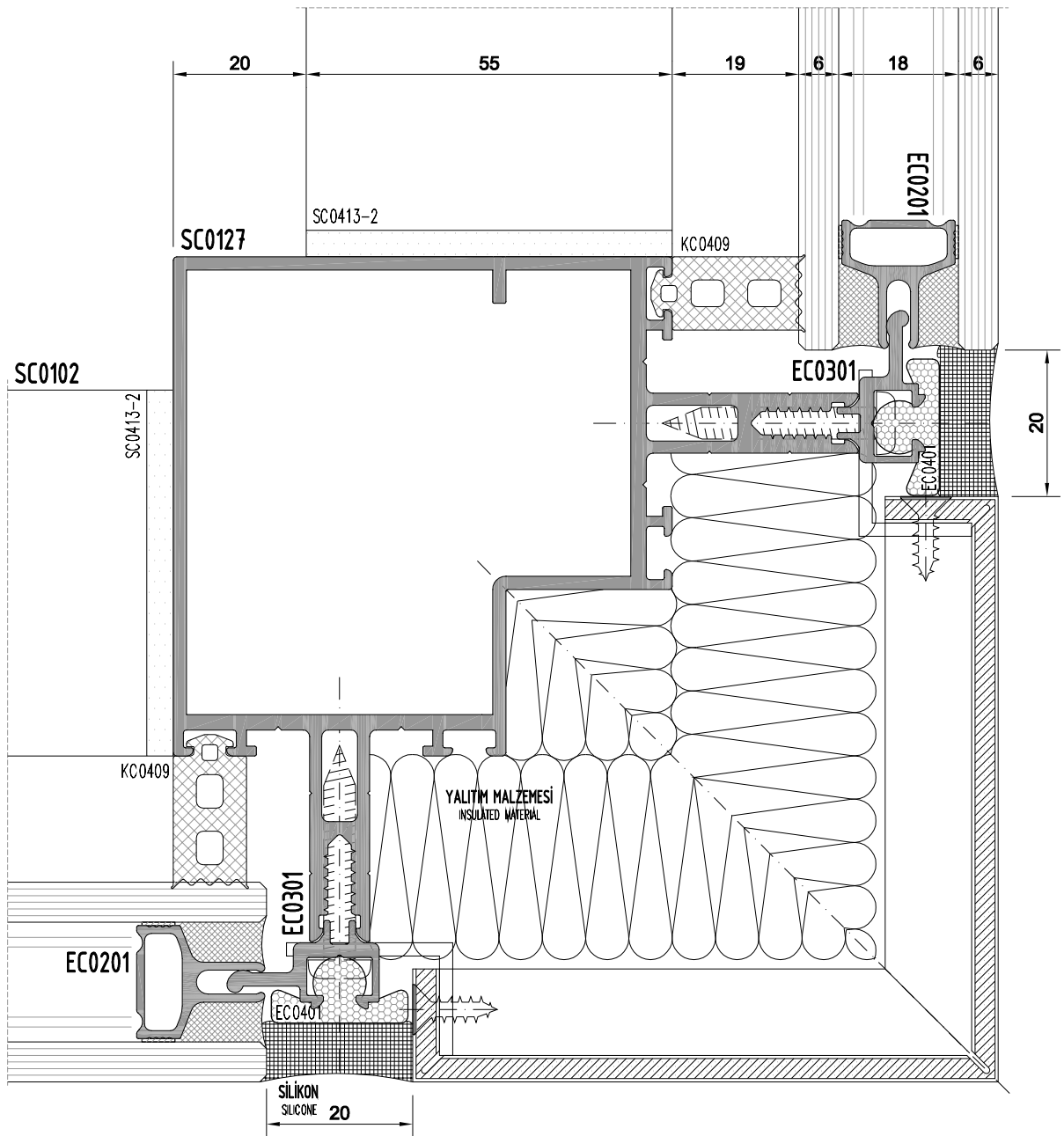
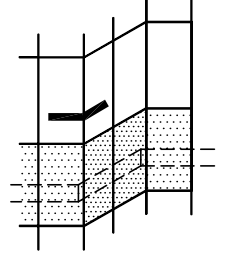

F50 KLASİK SİSTEM
ENTEĞRE CEPHE
F50 CLASSIC SYSTEM
İNTEĞRADET FAÇADE

KÖŞE DETAY
CORNER DETAIL

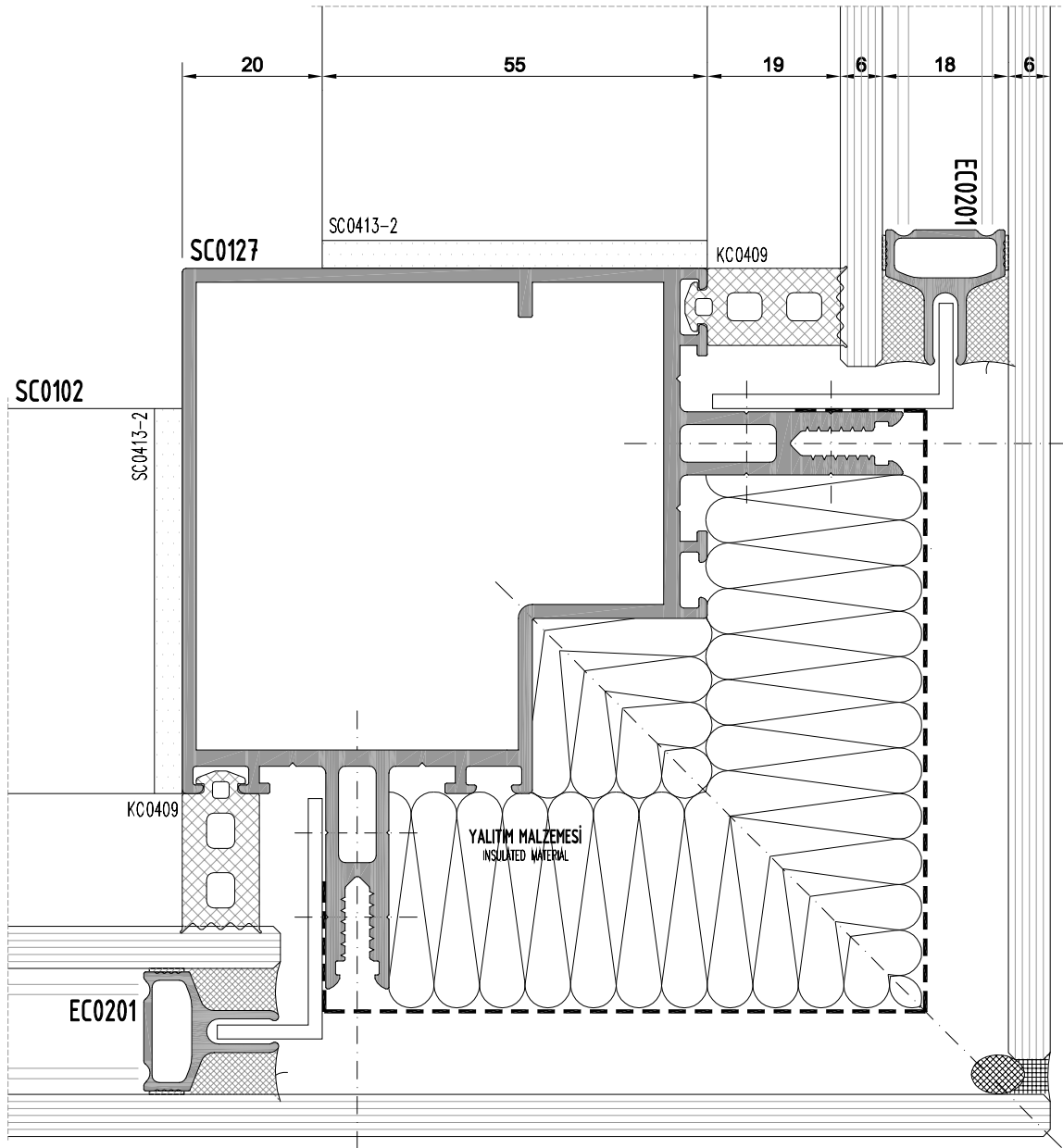
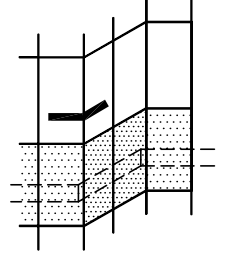

F50 KLASİK SİSTEM
ENTEĞRE CEPHE
F50 CLASSIC SYSTEM
İNTEĞRADET FAÇADE

KÖŞE DETAY
CORNER DETAIL

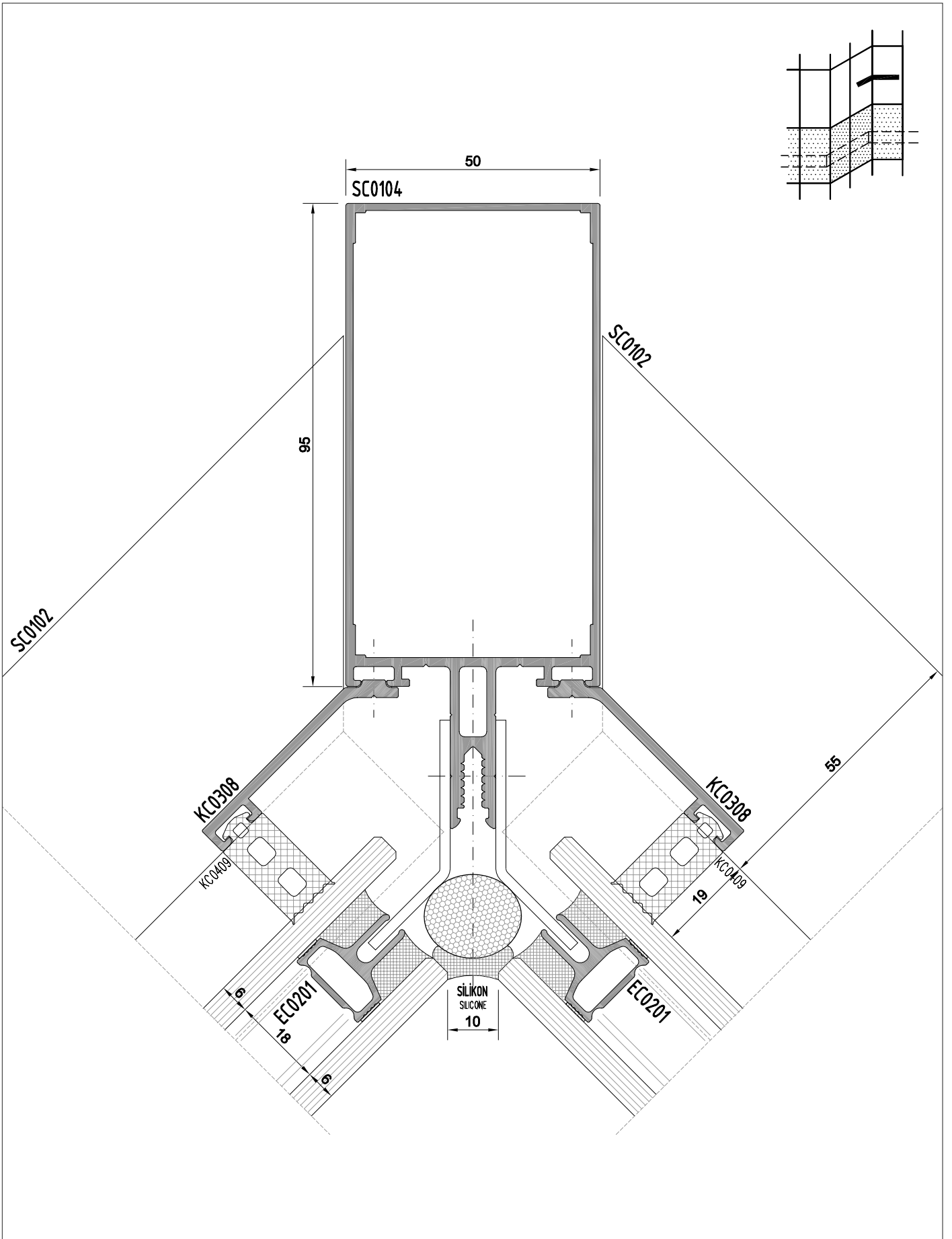

F50 KLASİK SİSTEM
ENTEĞRE CEPHE
F50 CLASSIC SYSTEM
İNTEĞRADET FAÇADE

KÖŞE DETAY
CORNER DETAIL

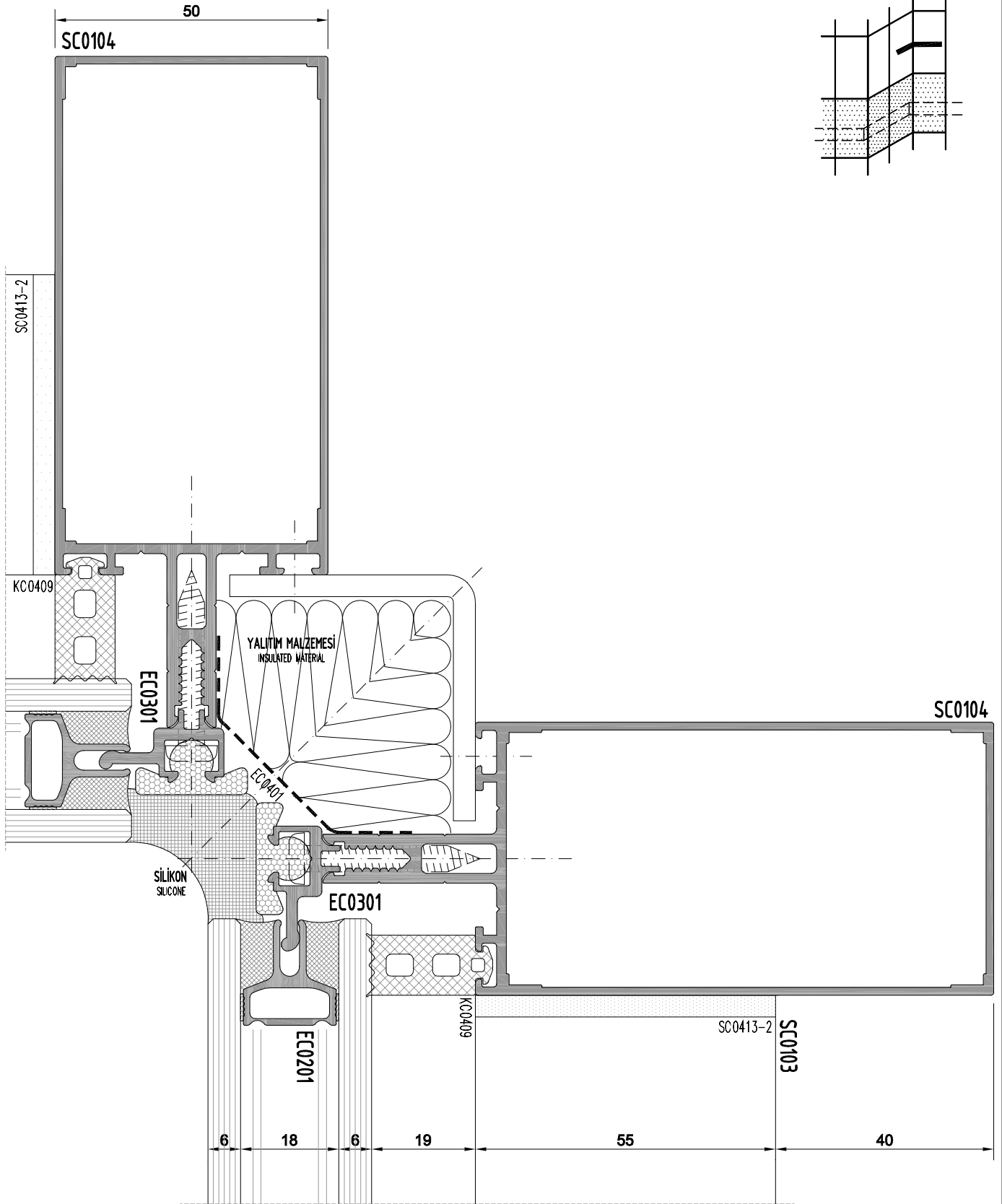





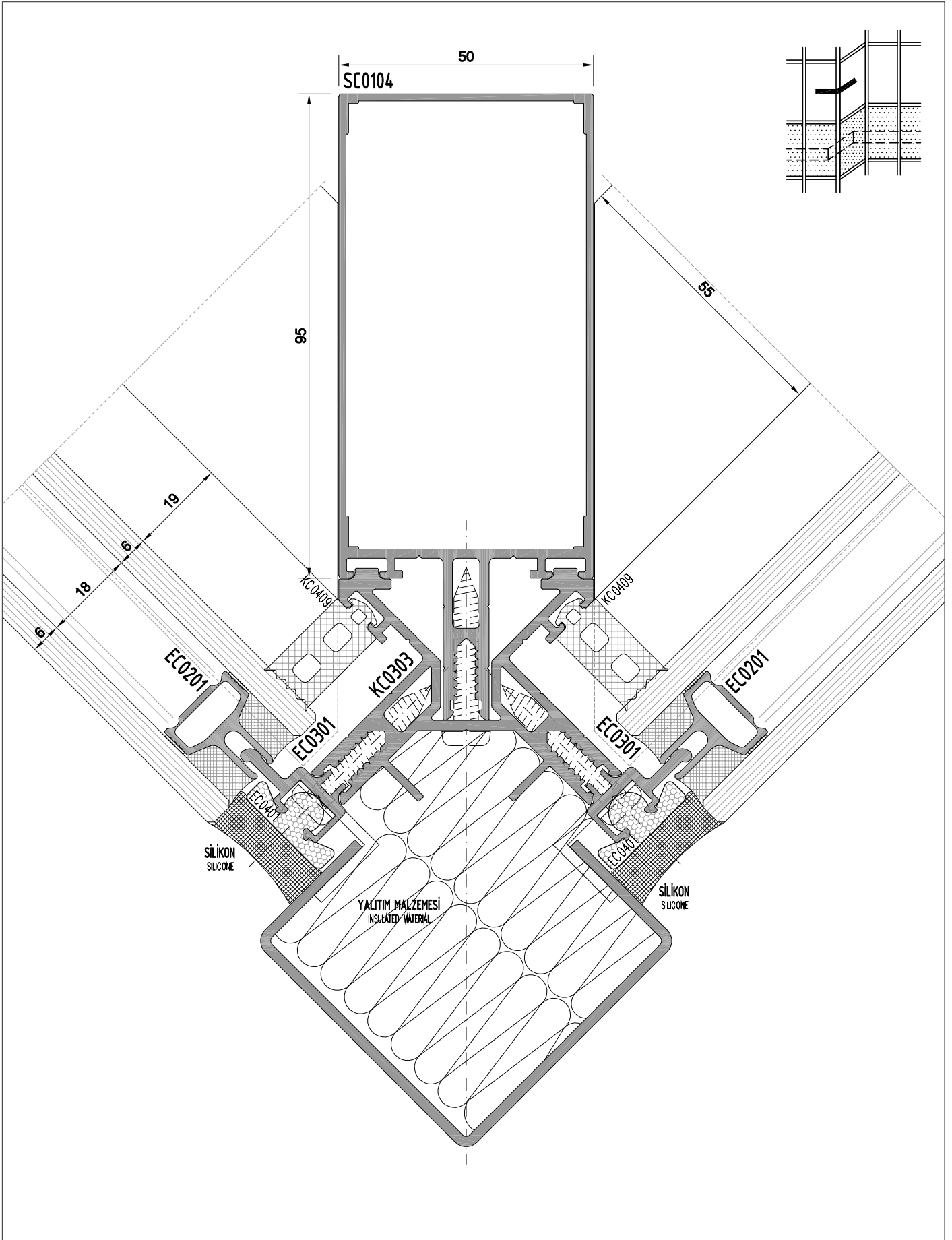

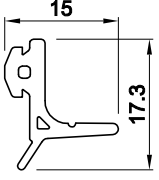
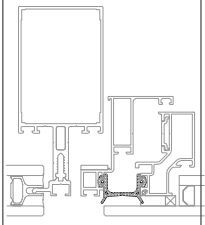
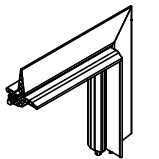
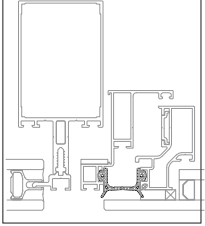
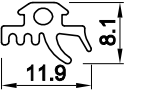
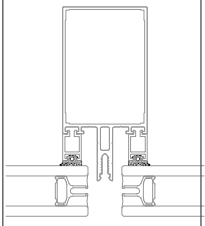

F50 KLASİK SİSTEM
ENTEĞRE CEPHE
F50 CLASSIC SYSTEM
İNTEĞRADET FAÇADE

KÖŞE DETAY
CORNER DETAIL

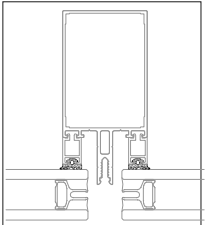

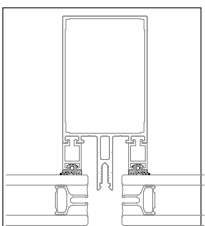
F50 KLASİK SİSTEM
ENTEĞRE CEPHE
F50 CLASSIC SYSTEM
INTEGRADET FAÇADE

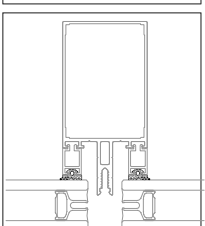
Fitil listesi
Gasket list

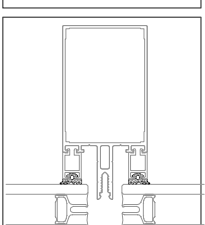
kod code	şekil drawing	tanım description	teorik ağırlık teoretical weight gr / m	paket ağırlığı package weight kg / package	paket metrajı in one package metre / package	kullanım yeri aplication
SC0401		Panel dış fitili Frame gasket	74 gr/m	15 kg	202 m	
SC0402		Panel dış fitili (köşe) Frame gasket (corner)	89 gr/m	-	50 ad-pcs	
SC0422		Taşıyıcı ve Panel iç fitili Mullion-transom or Panel gasket inside	46 gr/m	15 kg	326 m	
SC0407		Taşıyıcı ve Panel iç fitili Mullion-transom or Panel gasket inside	73 gr/m	15 kg	205 m	
SC0408		Taşıyıcı ve Panel iç fitili Mullion-transom or Panel gasket inside	88 gr/m	15 kg	170 m	
SC0409		Taşıyıcı ve Panel iç fitili Mullion-transom or Panel gasket inside	101 gr/m	15 kg	148 m	
SC0410		Taşıyıcı ve Panel iç fitili Mullion-transom or Panel gasket inside	113 gr/m	15 kg	133 m	

F50 KLASİK SİSTEM

ENTEĞRE CEPHE

F50 CLASSIC SYSTEM
INTEGRADET FAÇADE

Fitil listesi
Gasket list

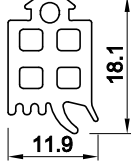
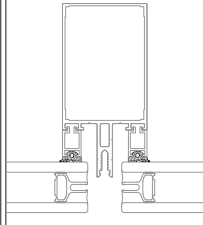
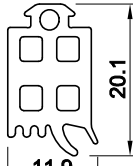
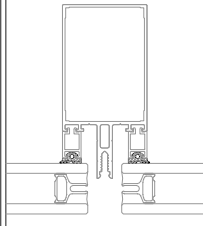
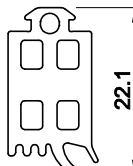
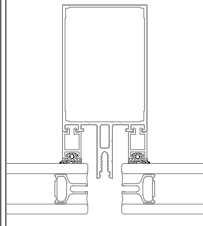
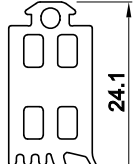
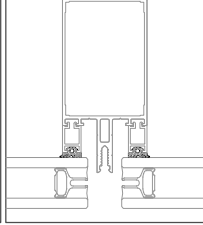
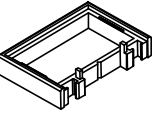
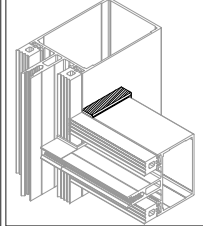
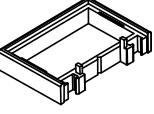
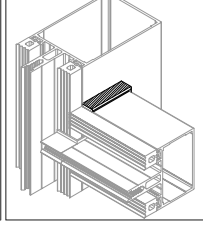
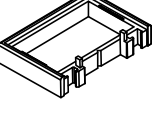
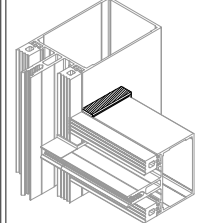
kod code	şekil drawing	tanım description	teorik ağırlık theoretical weight gr / m	paket ağırlığı package weight kg / package	paket metrajı in one package metre / package	kullanım yeri aplication
SC0411		Taşıyıcı ve Panel iç fitili Mullion-transom or Panel gasket inside	144 gr/m	15 kg	104 m	
SC0420		Taşıyıcı ve Panel iç fitili Mullion-transom or Panel gasket inside	167 gr/m	15 kg	90 m	
SC0421		Taşıyıcı ve Panel iç fitili Mullion-transom or Panel gasket inside	189 gr/m	15 kg	79 m	
SC0425		Taşıyıcı ve Panel iç fitili Mullion-transom or Panel gasket inside	217,6 gr/m	15 kg	69 m	
SC0412-1		Kırlangıç geçme Yaka fitili (37 lik) T-connector Gasket for transom (SC0101-SC0110)	7 gr/ad	-	50 ad-pcs	
SC0412-2		Kırlangıç geçme Yaka fitili (57 lik) T-connector Gasket for transom (SC0102-SC0111)	9,2 gr/ad	-	50 ad-pcs	
SC0412-3		Kırlangıç geçme Yaka fitili (77 lik) T-connector Gasket for transom (SC0103-SC0112)	11 gr/ad	-	50 ad-pcs	

F50 KLASİK SİSTEM
ENTEĞRE CEPHE
 F50 CLASSIC SYSTEM
 INTEGRADET FAÇADE

Fitil listesi
 Gasket list

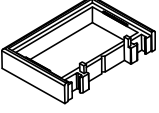
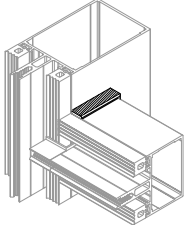
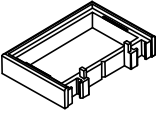
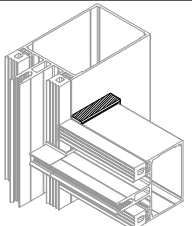
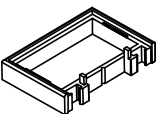
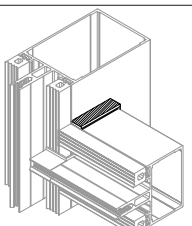
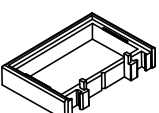
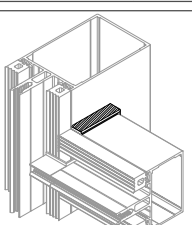
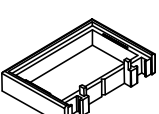
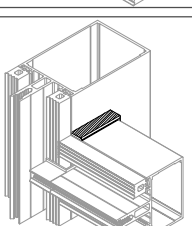
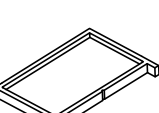
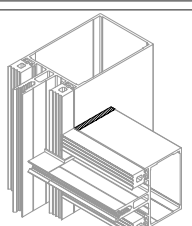
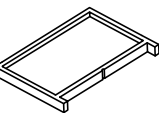
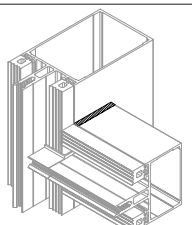
kod code	şekil drawing	tanım description	teorik ağırlık theoretical weight gr / m	paket ağırlığı package weight kg / package	paket metrajı in one package metre / package	kullanım yeri aplication
SC0412-4		Kırlangıç geçme Yaka fitili (97 lik) T-connector Gasket for transom (SC0104-SC0113)	13 gr/ad	-	50 ad-pcs	
SC0412-5		Kırlangıç geçme Yaka fitili (117 lik) T-connector Gasket for transom (SC0105-SC0114)	13 gr/ad	-	50 ad-pcs	
SC0412-6		Kırlangıç geçme Yaka fitili (137 lik) T-connector Gasket for transom (SC0106-SC0115)	17 gr/ad	-	50 ad-pcs	
SC0412-7		Kırlangıç geçme Yaka fitili (157 lik) T-connector Gasket for transom (SC0107-SC0116)	19 gr/ad	-	50 ad-pcs	
SC0412-8		Kırlangıç geçme Yaka fitili (177 lik) T-connector Gasket for transom (SC0108-SC0117)	21 gr/ad	-	50 ad-pcs	
SC0413-1		Klasik bağlantı Yaka fitili (35 lik) T-connector Gasket for transom (SC0101-SC0110)	-	-	50 ad-pcs	
SC0413-2		Klasik bağlantı Yaka fitili (55 lik) T-connector Gasket for transom (SC0102-SC0111)	-	-	50 ad-pcs	

F50 KLASİK SİSTEM

ENTEĞRE CEPHE

F50 CLASSIG SYSTEM
INTEGRADET FАСADE

Fitil listesi
Gasket list

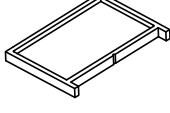
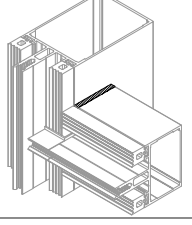
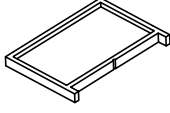
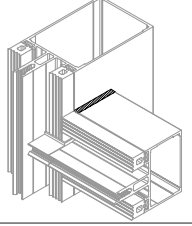
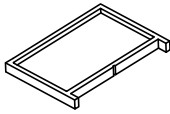
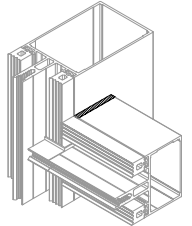
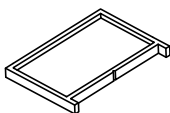
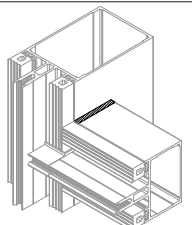
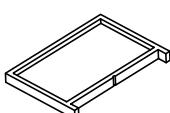
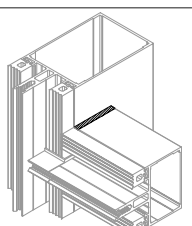
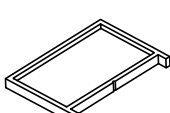
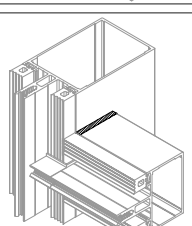
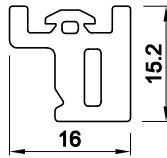
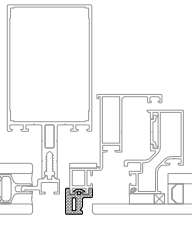
kod code	şekil drawing	tanım description	teorik ağırlık theoretical weight gr / m	paket ağırlığı package weight kg / package	paket metrajı in one package metre / package	kullanım yeri aplication
SC0413-3		Klasik bağlantı Yaka fitili (75 lik) T-connector Gasket for transom (SC0103-SC0112)	-	-	50 ad-pcs	
SC0413-4		Klasik bağlantı Yaka fitili (95 lik) T-connector Gasket for transom (SC0104-SC0113)	-	-	50 ad-pcs	
SC0413-5		Klasik bağlantı Yaka fitili (115 lik) T-connector Gasket for transom (SC0105-SC0114)	-	-	50 ad-pcs	
SC0413-6		Klasik bağlantı Yaka fitili (135 lik) T-connector Gasket for transom (SC0106-SC0115)	-	-	50 ad-pcs	
SC0413-7		Klasik bağlantı Yaka fitili (155 lik) T-connector Gasket for transom (SC0107-SC0116)	-	-	50 ad-pcs	
SC0413-8		Klasik bağlantı Yaka fitili (175 lik) T-connector Gasket for transom (SC0108-SC0117)	-	-	50 ad-pcs	
KC0405		Kasa dışı fitili Frame gasket	198 gr/m	15 kg	75 m	

F50 KLASİK SİSTEM

ENTEĞRE CEPHE

F50 CLASSIC SYSTEM
INTEGRADET FAÇADE

Fitil listesi
Gasket list

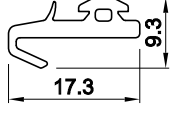
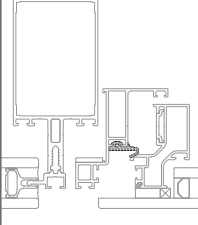
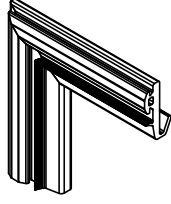
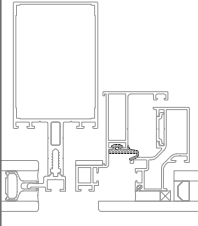
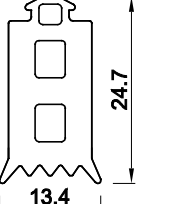
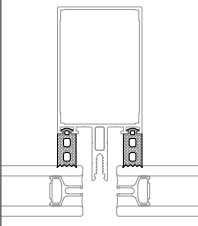
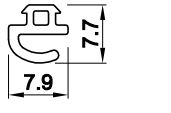
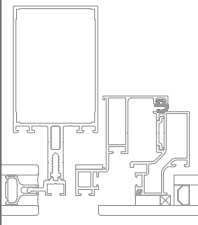
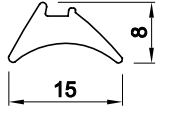
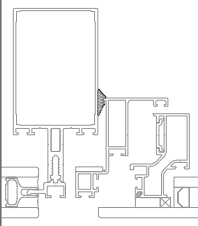
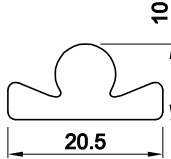
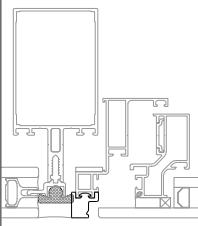
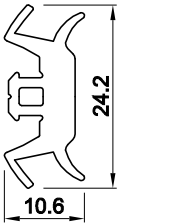
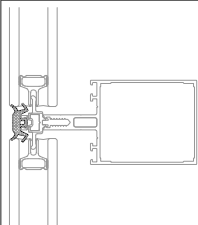
kod code	şekil drawing	tanım description	teorik ağırlık theoretical weight gr / m	paket ağırlığı package weight kg / package	paket metrajı in one package metre / package	kullanım yeri aplication
KC0407		Kasa bini fitili Frame gasket	72,5 gr/m	15 kg	207 m	
KC0408		Kasa bini köşe fitili Frame gasket (corner)	-	-	50 ad-pcs	
KC0409		Taşıyıcı ve Panel iç fitili Mullion-transom or Panel gasket inside	249 gr/m	15 kg	60 m	
KC0410		Kasa çarpma fitili Frame gasket	34 gr/m	15 kg	441 m	
KC0411		Kasa çarpma fitili Frame gasket	64 gr/m	15 kg	234 m	
EC0401		Poliüretan dolgu polyurethane gasket	-	-	6 m	
EC0402		Derz fitili joint gasket	163 gr/m	15 kg	100 m	

F50 KLASİK SİSTEM

ENTEĞRE CEPHE

F50 CLASSIC SYSTEM
INTEGRADET FAÇADE

Fitil listesi

Gasket list

kod code	şekil drawing	tanım description	teorik ağırlık theoretical weight gr / m	paket ağırlığı package weight kg / package	paket metraji in one package metre / package	kullanım yeri aplication
EC0403		Kasa bini fitili Frame gasket	80 gr/m	15 kg	188 m	
EC0404		Panel dış fitili Frame gasket	59 gr/m	15 kg	254 m	

F50 KLASİK SİSTEM
ENTEĞRE CEPHE
F50 CLASSIC SYSTEM
INTEGRATED FACADE

Pvc ızalasyon listesi
Pvc ızalator list

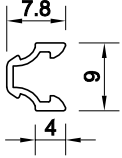
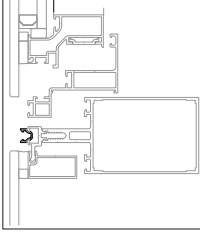
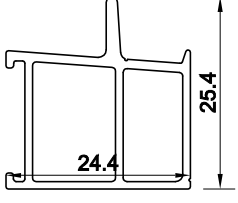
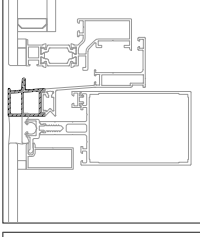
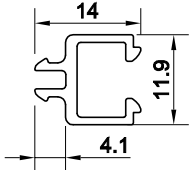
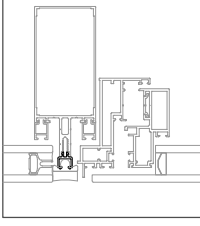
kod code	şekil drawing	tanım description	metraji metre / package	kullanım yeri aplication
F0500		Taşıyıcı ön ızalasyon (pvc) Mullion or transom front ızalator (pvc)	6 m	
F0520		Kasa profili ızalasyon (pvc) Frame profile ızalator (pvc)	6 m	
EC0501		Taşıyıcı ön ızalasyon (pvc) Mullion or transom front ızalator (pvc)	6 m	

F50 KLASİK SİSTEM

ENTEĞRE CEPHE

F50 CLASSIC SYSTEM
INTEGRATED FAÇADE

silikon fitil listesi

gasket list

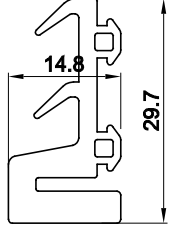
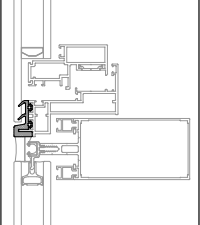
kod code	şekil drawing	tanım description	teorik ağırlık theoretical weight gr / m	paket ağırlığı package weight kg / package	paket metraji in one package metre / package	kullanım yeri aplication
EC0405		Kasa dışı fitili Frame gasket	295 gr/m	15 kg	50 m	

F50 KLASİK SİSTEM
ENTEĞRE CEPHE
F50 CLASSIC SYSTEM
İNTEĞRADET FAÇADE

İMALAT ŞEMASI
PRODUCTION PLAN

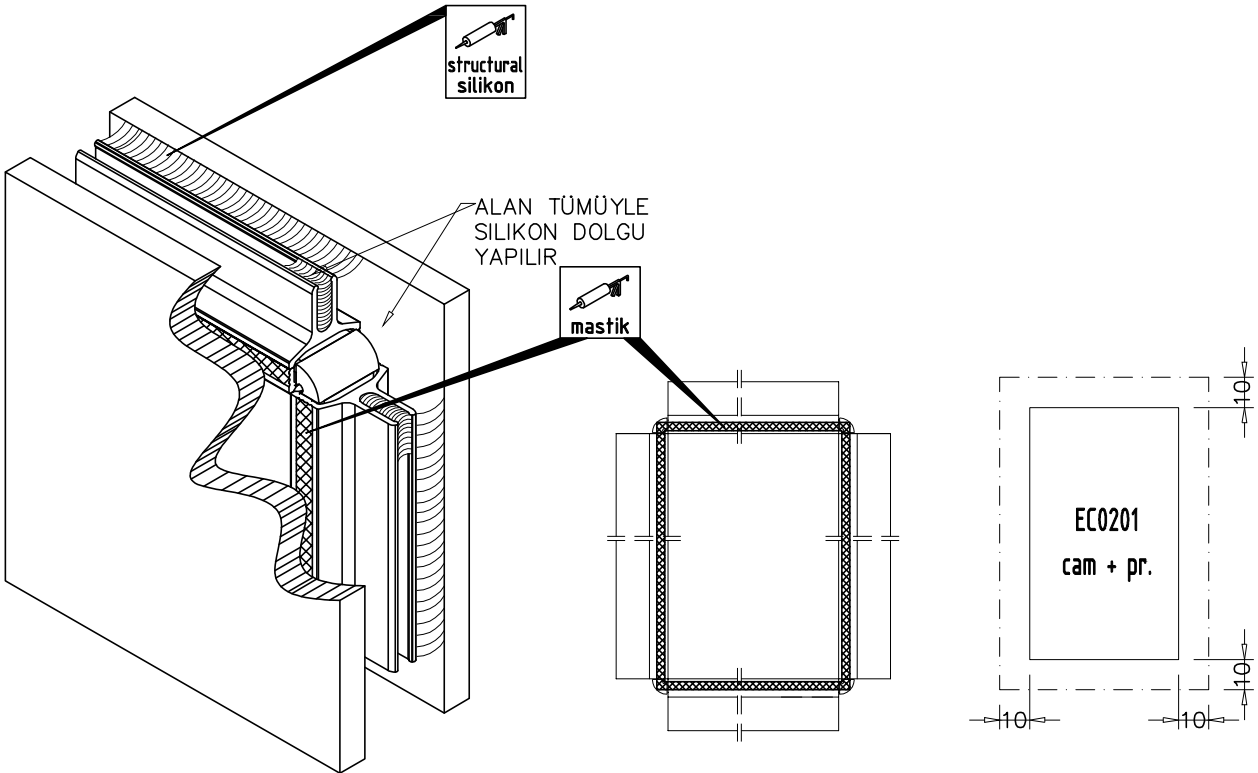
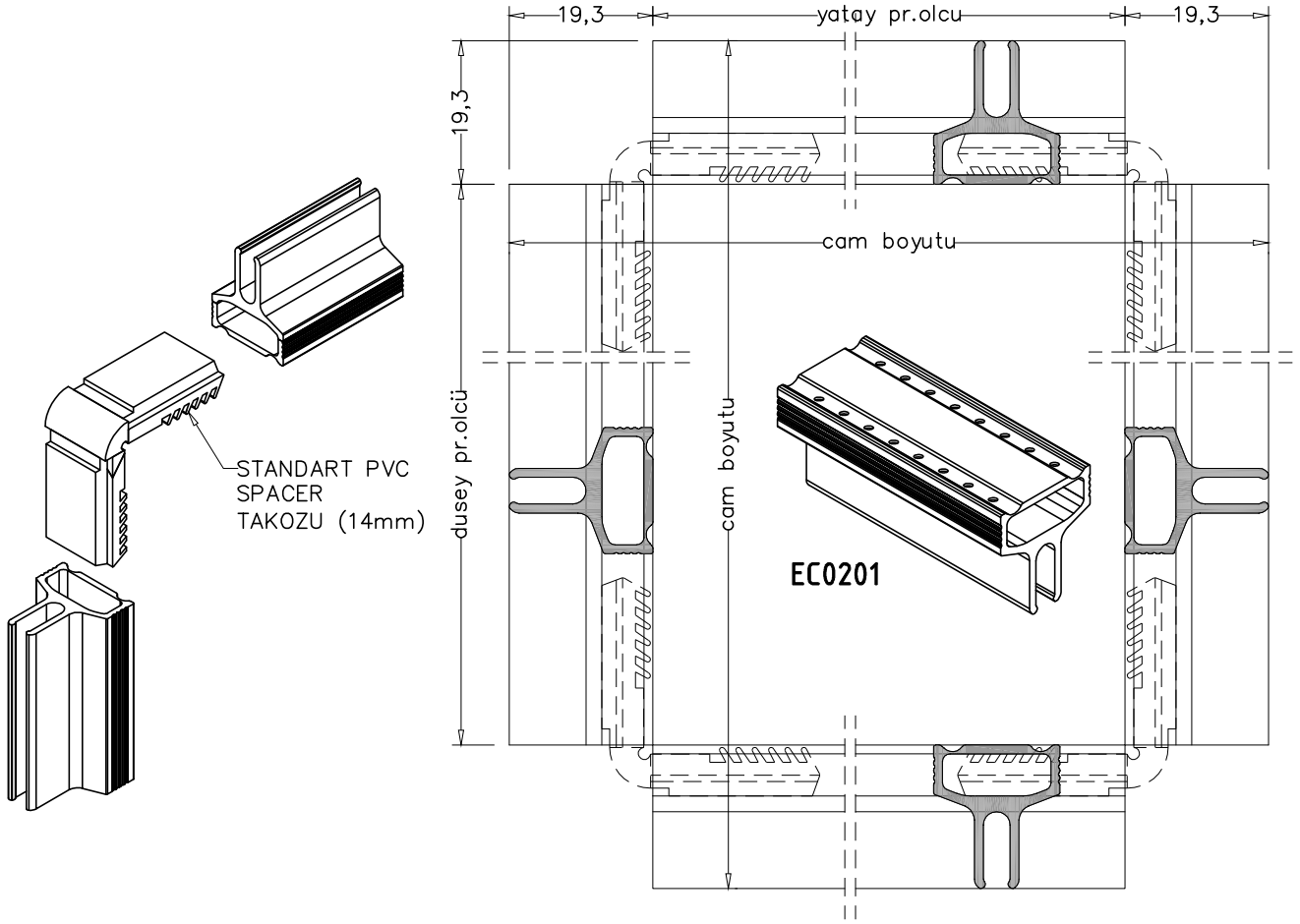

F50 KLASİK SİSTEM
ENTEĞRE CEPHE
F50 CLASSIC SYSTEM
İNTEĞRADET FAÇADE

İMALAT ŞEMASI
PRODUCTION PLAN

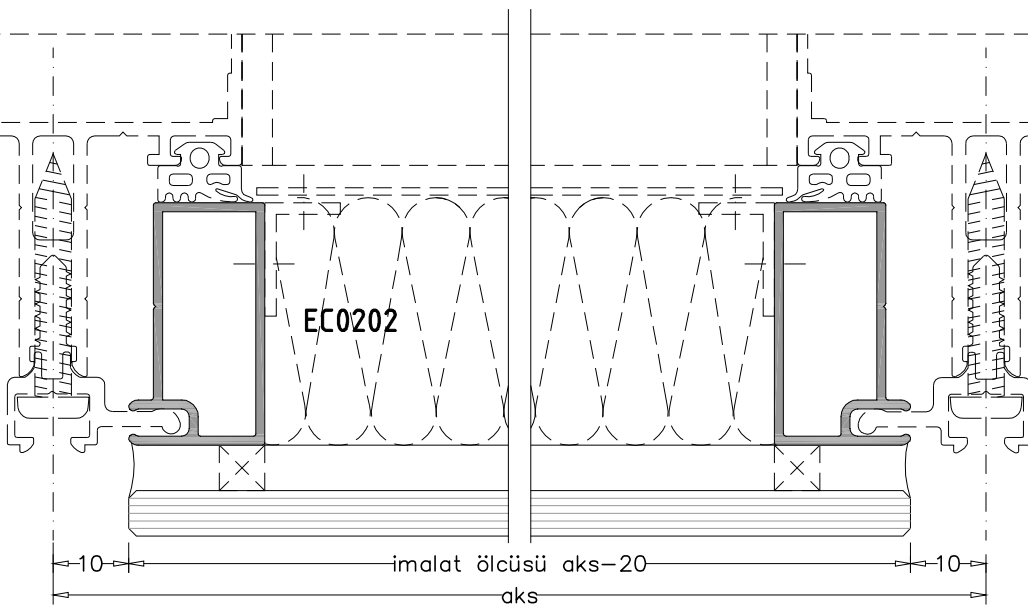
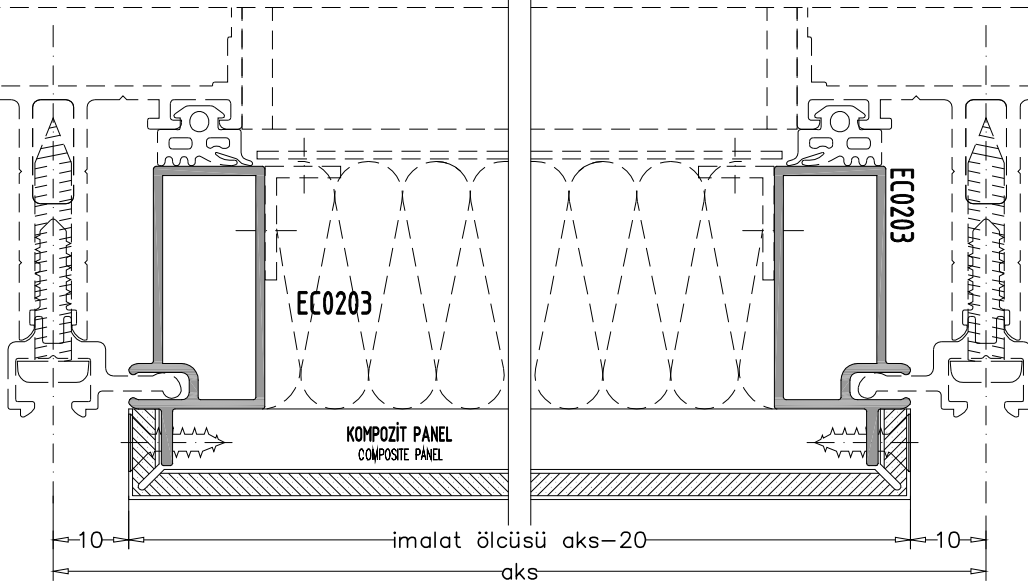
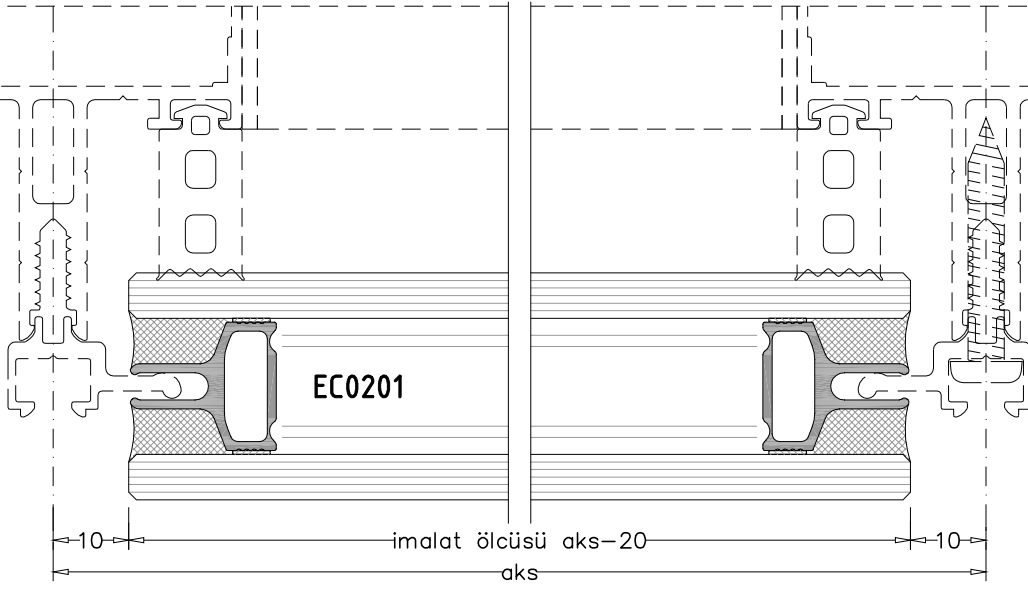

F50 KLASİK SİSTEM
ENTEĞRE CEPHE
F50 CLASSIC SYSTEM
İNTEĞRADET FAÇADE

İMALAT ŞEMASI
PRODUCTION PLAN

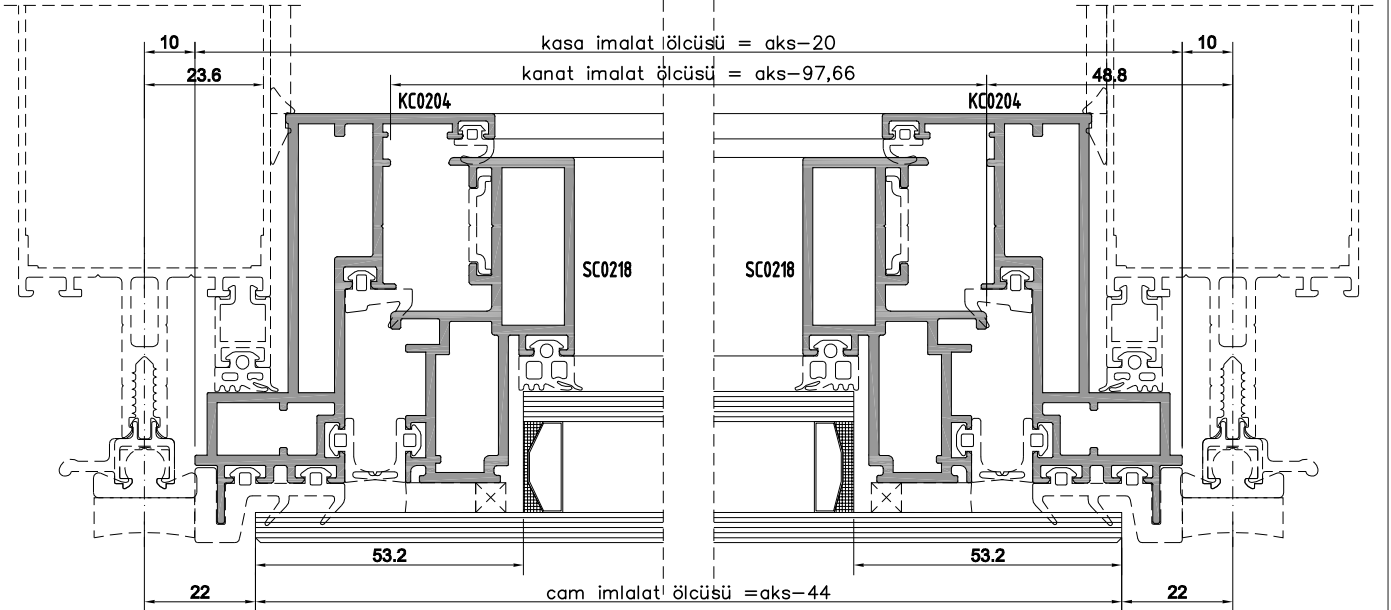
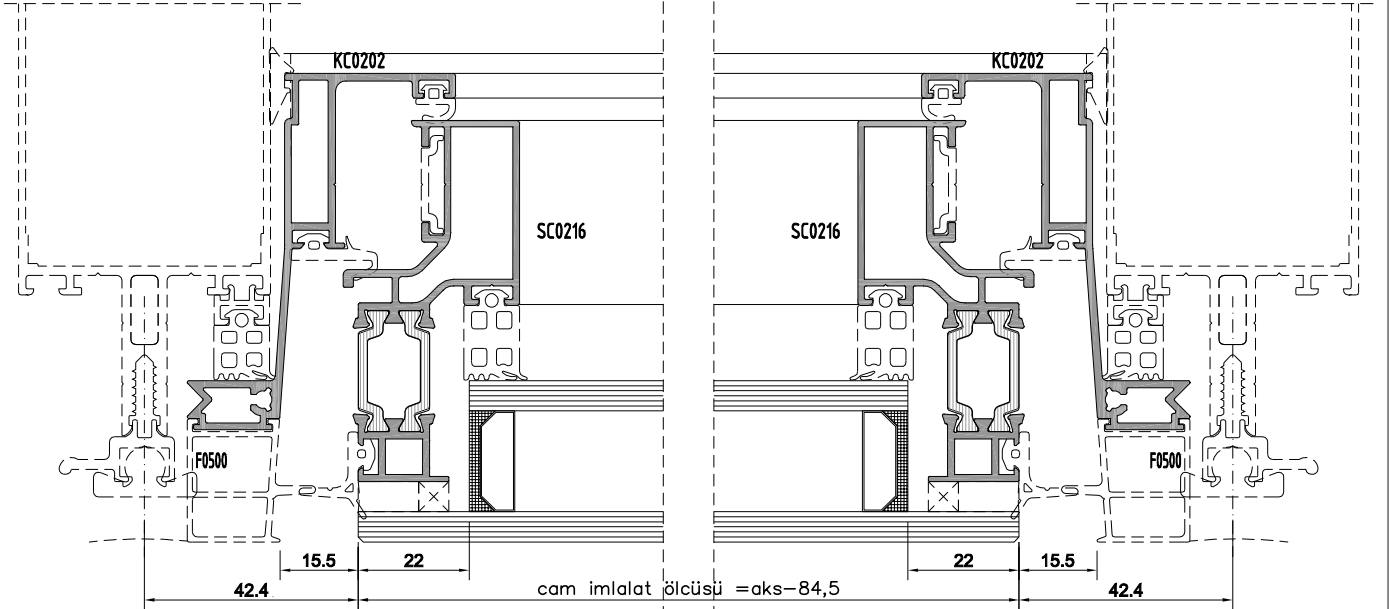
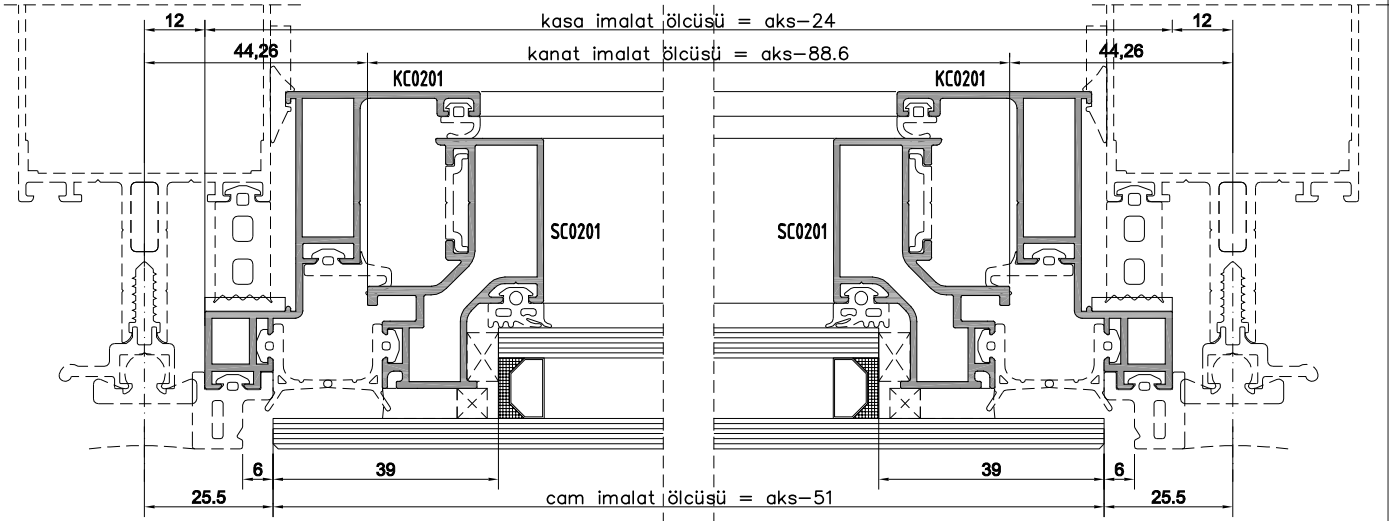

F50 KLASİK SİSTEM
ENTEĞRE CEPHE
F50 CLASSIC SYSTEM
İNTEĞRADET FAÇADE

İMALAT ŞEMASI
PRODUCTION PLAN

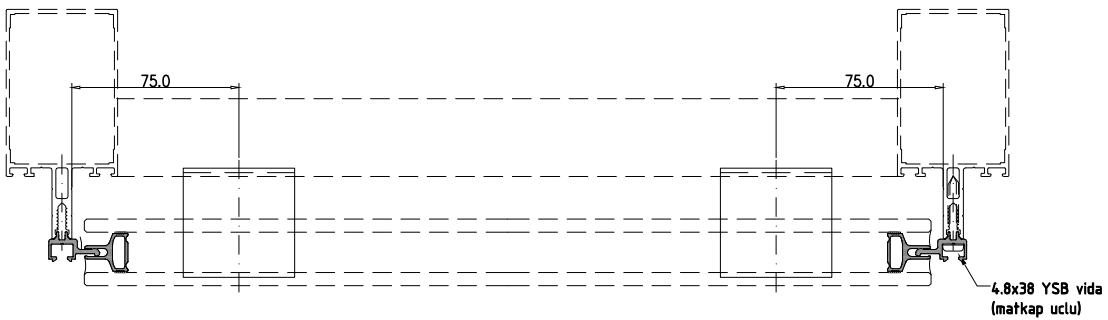
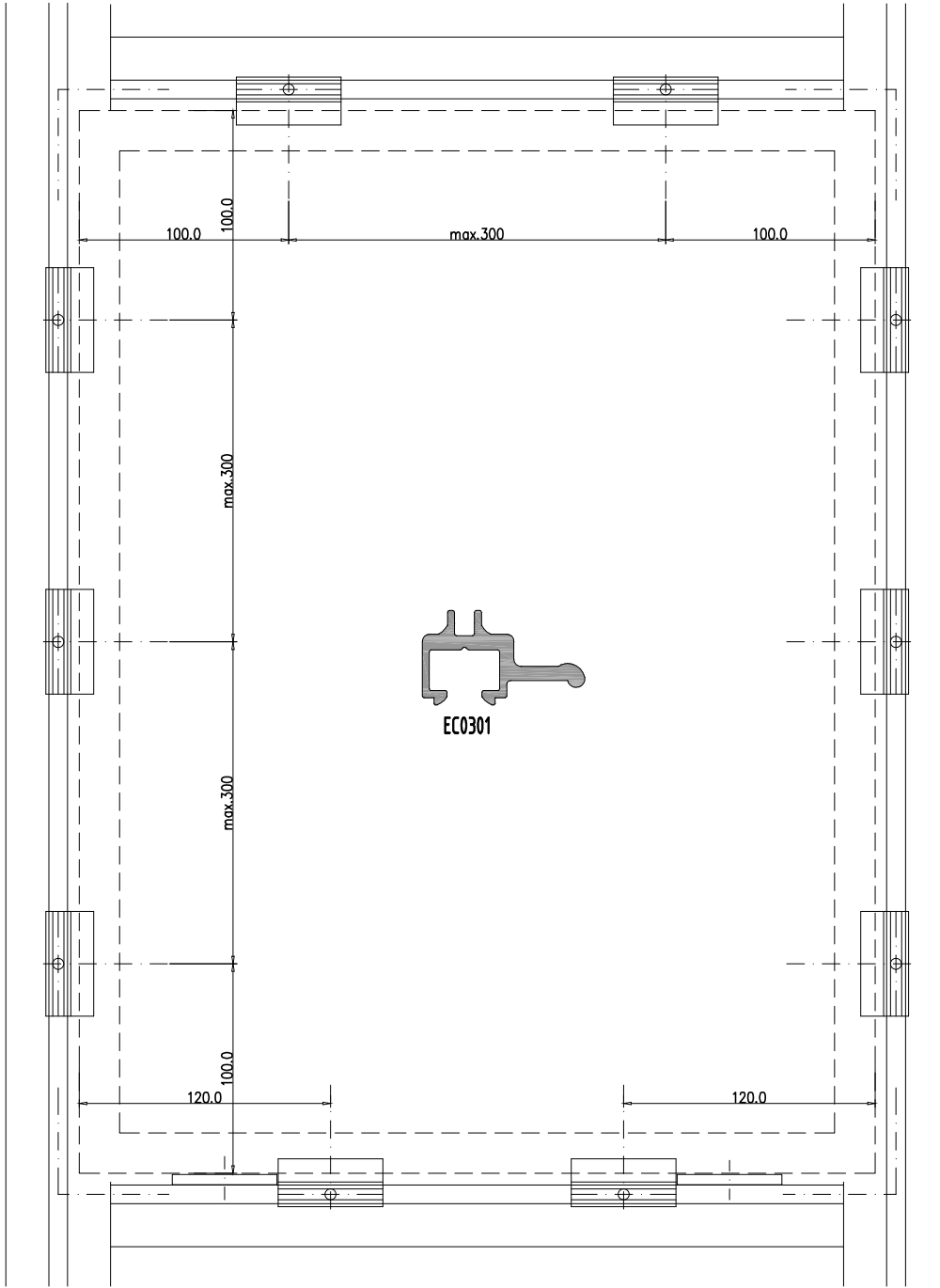

F50 KLASİK SİSTEM
ENTEĞRE CEPHE
F50 CLASSIC SYSTEM
İNTEĞRADET FAÇADE

İMALAT ŞEMASI
PRODUCTION PLAN

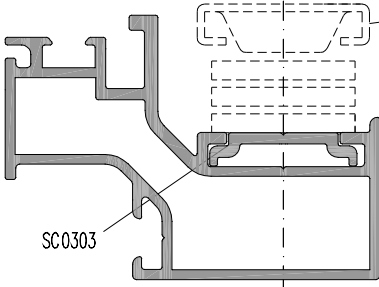
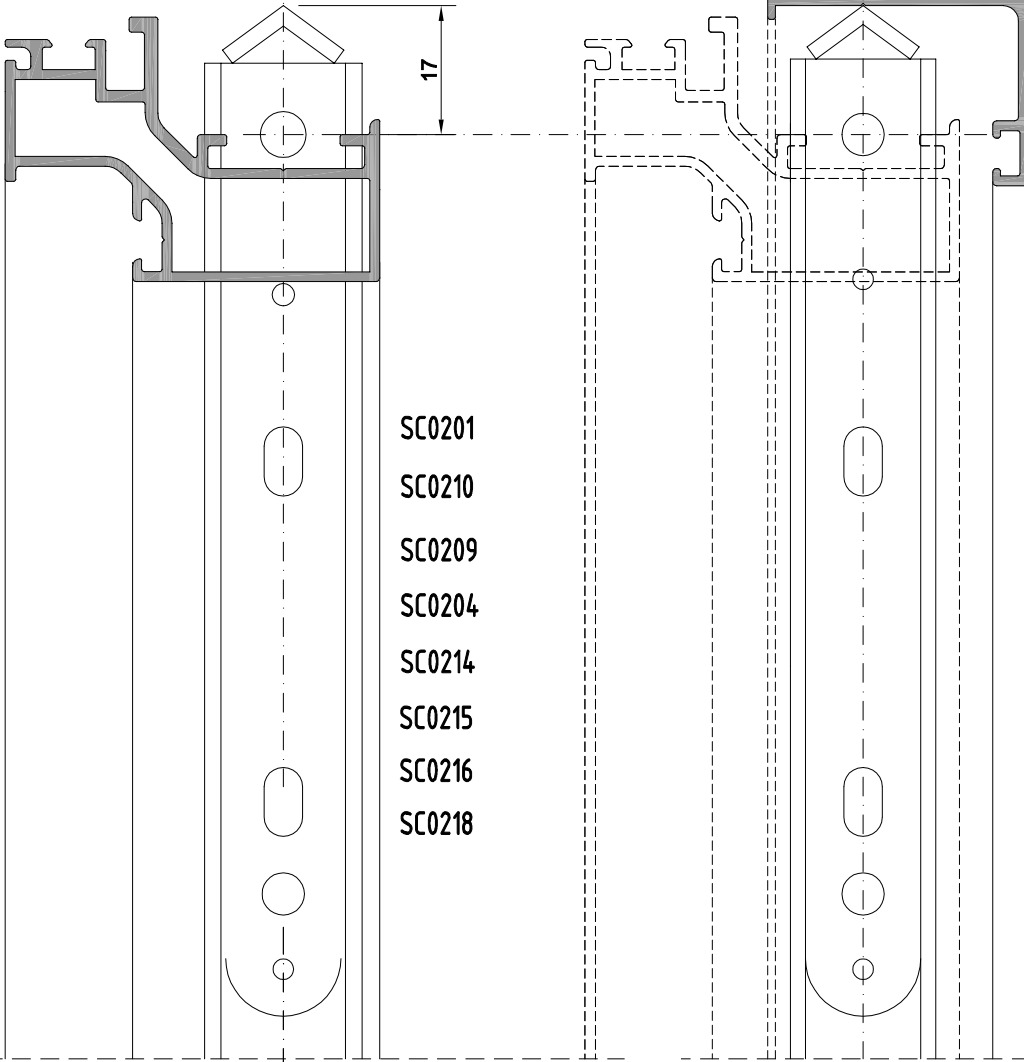
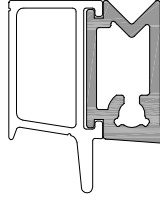
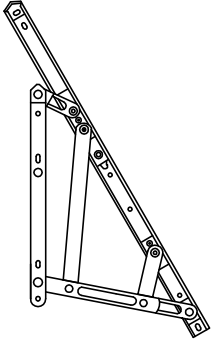

- SC0319
- SC0320
- SC0321
- SC0322
- SC0323
- SC0324
- SC0325
- SC0326
- SC0327

SC0303

F50 KLASİK SİSTEM

ENTEĞRE CEPHE

F50 CLASSIC SYSTEM
INTEĞRADET FAÇADE

AKSESUARLAR

ACCESSOIRES

PANEL OTURTMA TAKOZU (PVC) SUPPORT FOR PANEL (PVC)

SC0305 (yerli) (native)

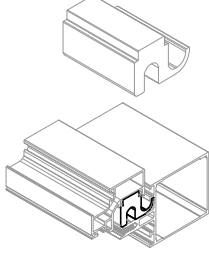

AYARLI PİM KARŞILĞI ADJUSTABLE STRIKER FOR WINDOW

SC0318 (ithal) (import)



SC0318-a (yerli) (native)

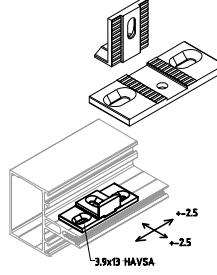

KONDENS PLASTİĞİ CONDENSAT PLASTIC

SC0345 (yerli) (native)

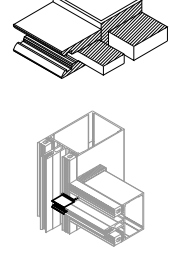

ÇİFT DİLLİ CEPHE KOLU FAÇADE HANDLE

SC0329 (ithal) (import) SC0329-a (yerli) (native) naturel eloksalli (mat anodized)
SC0330 (ithal) (import) SC0330-a (yerli) (native) pres veya renkli (mill finishand and painted)

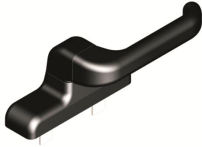

ÇİFT DİLLİ ANAHTARLI CEPHE KOLU FAÇADE HANDLE (KEY)

SC0333 (ithal) (import) SC0333-a (yerli) (native) naturel eloksalli (mat anodized)
SC0334 (ithal) (import) SC0334-a (yerli) (native) pres veya renkli (mill finishand and painted)



CEPHE KOLU TİJ BAĞLANTI PABUCU CONNECTION BLOCK FOR FAÇADE HANDLE

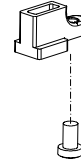

SC0303-a (ithal) (import)
SC0303-b (yerli) (native)

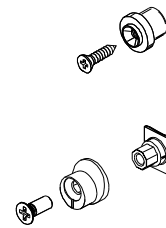
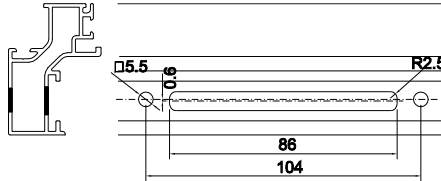
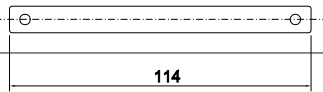
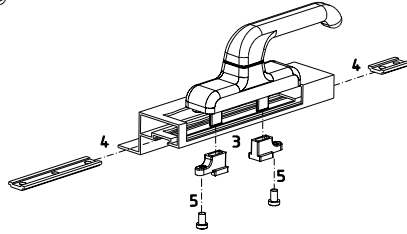
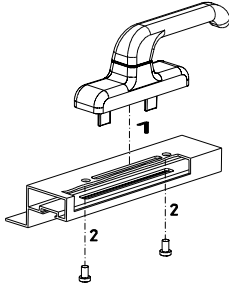
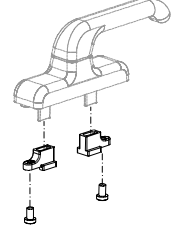

PİM
PIN

W-878 (ithal) (import)
W-878-a (yerli) (native)

AYARLANABİLİR PİM
ADJUSTABLE FASTENING PAWL

W-879 (ithal) (import)
W-879-a (yerli) (native)

KÖŞE HAREKET AKTARICISI MONTION CORNER TRANSMITTER

SC0328 (ithal) (import) SC0328-a (yerli) (native)



TEK DİLLİ CEPHE KOLU FAÇADE HANDLE

SC0331 (ithal) (import) naturel eloksalli (mat anodized)
SC0331-a (yerli) (import) naturel eloksalli (mat anodized)
SC0332 (ithal) (native) pres veya renkli (mill finishand and painted)
SC0332-a (yerli) (native) pres veya renkli (mill finishand and painted)

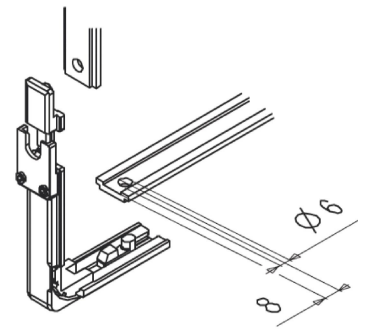
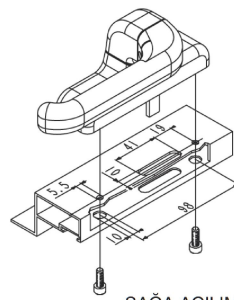
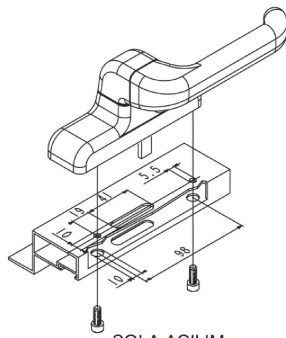
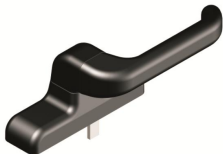

F50 KLASİK SİSTEM

ENTEĞRE CEPHE

F50 CLASSIC SYSTEM
İNTEĞRADET FAÇADE

AKSESUARLAR
ACCESSOIRES

DALDIRMA GALVENİZLİ SABİT U ANKRAJ (YATAY BAKLALI) DIP GALVANIZED FIX "U" ANCHOR (HORIZONTAL)

- SC0338-2 (yerli) (native) L= 80 mm
- SC0339-2 (yerli) (native) L= 100 mm
- SC0340-2 (yerli) (native) L= 120 mm
- SC0341-2 (yerli) (native) L= 150 mm
- SC0342-2 (yerli) (native) L= 200 mm

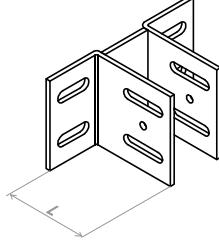

DALDIRMA GALVENİZLİ SABİT U ANKRAJ (DÜŞEY BAKLALI) DIP GALVANIZED FIX "U" ANCHOR (VERTICAL)

- SC0338-1 (yerli) (native) L= 80 mm
- SC0339-1 (yerli) (native) L= 100 mm
- SC0340-1 (yerli) (native) L= 120 mm
- SC0341-1 (yerli) (native) L= 150 mm
- SC0342-1 (yerli) (native) L= 200 mm

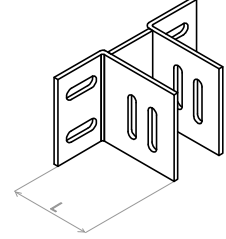

TAŞIYICI DİLATASYON PLASTİĞİ DILATATION PLASTIC FOR MULLION

EC0303 (yerli) (native)

