

KOMPOZİT KLİPSLİ TAŞIYICI SİSTEM
COMPOSITE CLIP CARRIER SYSTEM

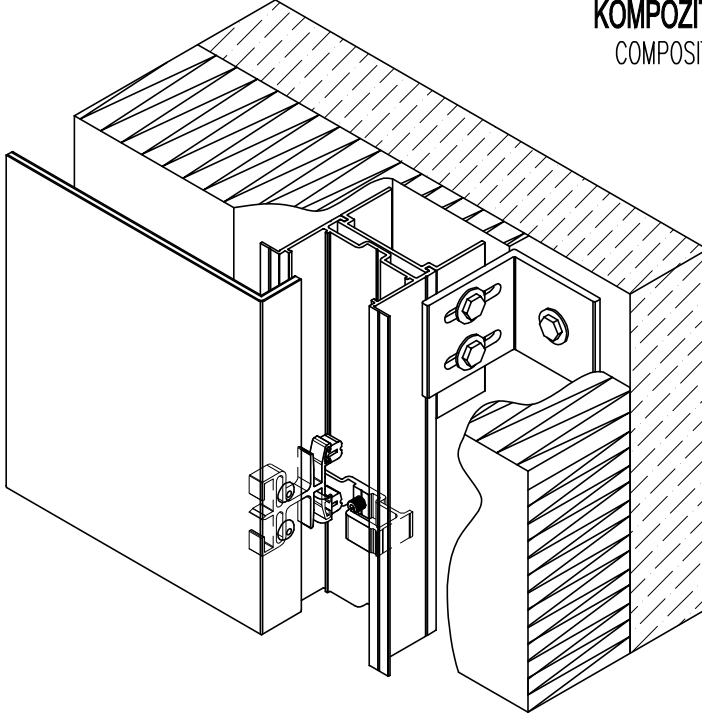

KOMPOZİT KERTMELİ TAŞIYICI SİSTEM
COMPOSITE NOTCHED CARRIER SYSTEM

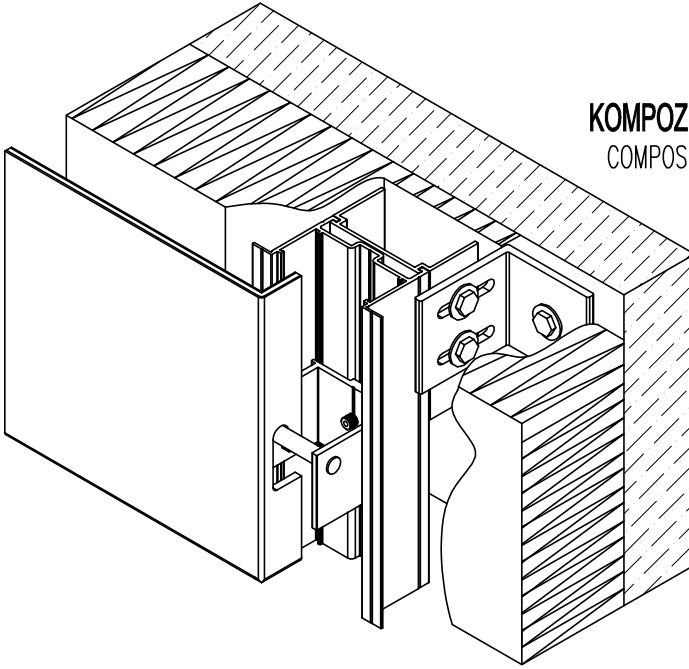











KP

KOMPOZİT PANEL TAŞIYICI SİSTEMİ
COMPOSITE PANEL CARRIER SYSTEM

KP
KOMPOZİT PANEL TAŞIYICI SİSTEMİ
COMPOSITE PANEL CARRIER SYSTEM

ÜRÜN TEKNİK ÖZELLİKLERİ
PRODUCT'S TECHNICAL FEATURES



No. Nr.	PROFİL KESİTİ PROFILE VIEW	PROFİL NO PROFILE NO	PROFİL AÇIKLAMASI PROFILE DESCRIPTION	BAĞLANTI PARÇALARI CORNER CLEATS	gr/m	STATİK STATIC			
						I_x cm ⁴	I_y cm ⁴	W_x cm ³	W_y cm ³
1		KP0101 (80 - 40) (2 mm)	TAŞIYICI PROFİL MULLION PROFILE	KP0301	914				
2		KP0201 (55.6 - 22.2) (2 mm)	TAŞIYICI ADAPTÖR PROFİL MULLION ADAPTER PROFILE	KP0101	998				
3		KP0202 (42.8 - 40) (2 mm)	PANEL KLİPS PROFİL PANEL CLIP PROFILE	KP0201	1294				
4		KP0203 (39 - 8.1) (15 mm)	H PROFİL H PROFILE		245				
5		KP0204 (39 - 5.9) (15 mm)	H PROFİL H PROFILE		233				
6		KP0205 (30 - 8.2) (14 mm)	L PROFİL L PROFILE		201				
7		KP0206 (30 - 20) (15 mm)	F PROFİL F PROFILE		251				
8		KP0207 (40 - 10.2) (11 mm)	H PROFİL H PROFILE		210				
9		KP0208 (55.5 - 53) (3 mm)	TAŞIYICI ADAPTÖR PROFİL MULLION ADAPTER PROFILE	KP0101	1125				
10		KP0209 (19.8 - 18) (11 mm)	TAŞIYICI ADAPTÖR PROFİL MULLION ADAPTER PROFILE	KP0210	143				

Profil değerleri teoriktir. Ağırlık olarak testimde yapılan tartım geçerlidir.
Profil imatları TS EN 12020-2 ve TS EN 755-9 toleransı,
Moment değerleri EN 14024'e göre hesaplanmıştır.

Profile values are theoretical pre-shipment weight will be valid.
The tolerances of Profile manufacturing are calculated according to EN 12020-2
and TS EN 755-9; moment values are calculated according to EN 14024.

KP
KOMPOZİT PANEL TAŞIYICI SİSTEMİ
COMPOSITE PANEL CARRIER SYSTEM

ÜRÜN TEKNİK ÖZELLİKLERİ
PRODUCT'S TECHNICAL FEATURES

No. Nr.	PROFİL KESİTİ PROFILE VIEW	PROFİL NO PROFILE NO	PROFİL AÇIKLAMASI PROFILE DESCRIPTION	BAĞLANTI PARÇALARI CORNER CLEATS	gr/m	STATİK STATIC			
						Ix cm ⁴	Iy cm ⁴	Wx cm ³	Wy cm ³
11		KP0210 (55,5 - 53) (3 mm)	TAŞIYICI ADAPTÖR PROFİL MULLION ADAPTER PROFILE	KP0209	144				
12		KP0211 (39 - 9,1) (15 mm)	H PROFİL H PROFILE		249				
13		KP0301 (60 - 34,8)	TAŞIYICI ADAPTÖR PROFİL MULLION ADAPTER PROFILE	KP0101	706				
14									
15									
16									
17									
18									
19									
20									

Profil değerleri teoriktir. Ağırlık olarak testimde yapılan tartım geçerlidir.
Profil imalatları TS EN 12020-2 ve TS EN 755-9 toleransı,
Moment değerleri EN 14024'e göre hesaplanmıştır.

Profile values are theoretical pre-shipment weight will be valid.
The tolerances of Profile manufacturing are calculated according to EN 12020-2
and TS EN 755-9; moment values are calculated according to EN 14024.

KP
KOMPOZİT PANEL TAŞIYICI SİSTEMİ
COMPOSITE PANEL CARRIER SYSTEM

ÜRÜN TEKNİK ÖZELLİKLERİ
PRODUCT'S TECHNICAL FEATURES

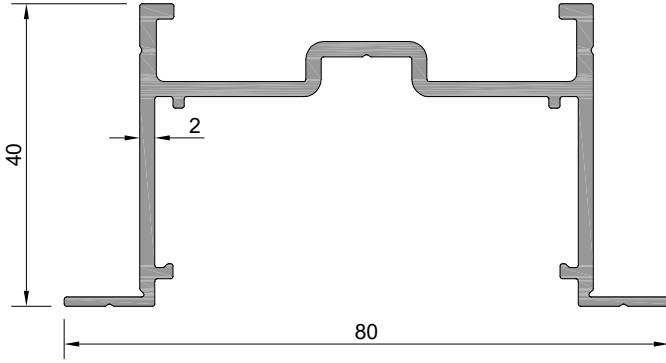

Profil No: KP0101
Ağırlık : 914 gr/m

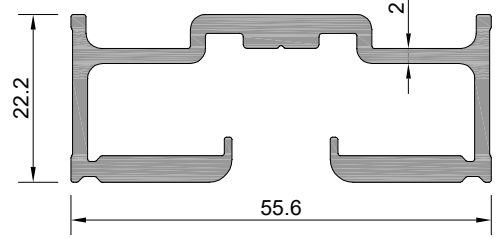

Profil No: KP0201
Ağırlık : 998 gr/m

KP0201-a	20 mm	100 adet/pcs	6x12 mm setiskur vida
----------	-------	--------------	-----------------------

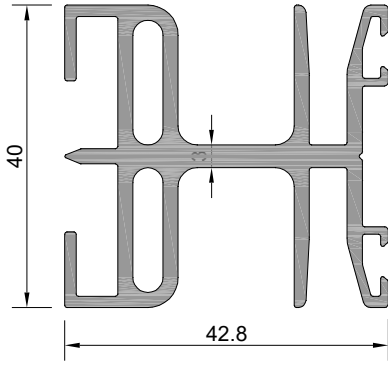

Profil No: KP0202
Ağırlık : 1294 gr/m

KP0202-a	8 mm	100 adet/pcs	KC0413 epdm
----------	------	--------------	-------------

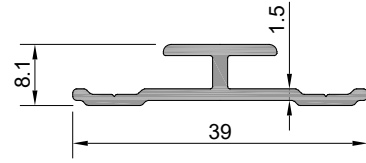

Profil No: KP0203
Ağırlık : 245 gr/m

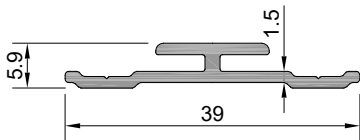

Profil No: KP0204
Ağırlık : 233 gr/m

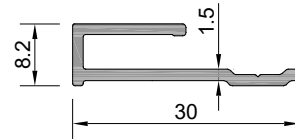

Profil No: KP0205
Ağırlık : 201 gr/m

KP
KOMPOZİT PANEL TAŞIYICI SİSTEMİ
COMPOSITE PANEL CARRIER SYSTEM

ÜRÜN TEKNİK ÖZELLİKLERİ
PRODUCT'S TECHNICAL FEATURES

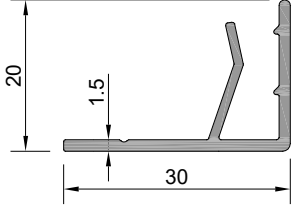

Profil No : KP0206
Ağırlık : 251 gr/m

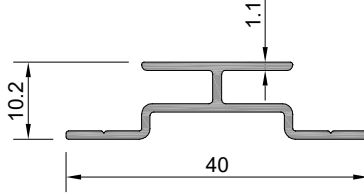

Profil No : KP0207
Ağırlık : 210 gr/m

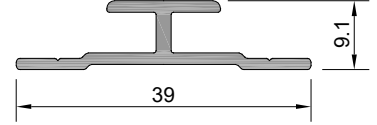

Profil No : KP0211
Ağırlık : 249 gr/m

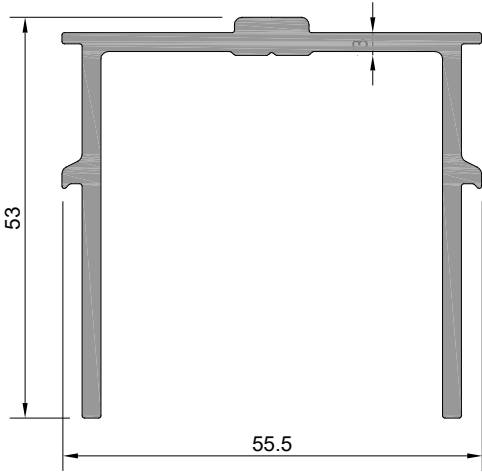

Profil No : KP0208
Ağırlık : 1125 gr/m

KP0208-a	40 mm	100 adet/pcs	8 mm boru profil 6x12 mm setiskur vida
----------	-------	--------------	---

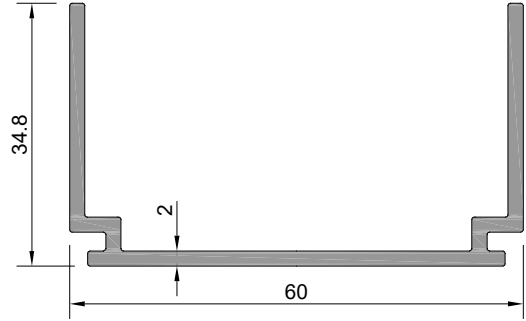

Profil No : KP0301
Ağırlık : 706 gr/m

KP0301-a	80 mm	100 adet/pcs
----------	-------	--------------

KP
KOMPOZİT PANEL TAŞIYICI SİSTEMİ
COMPOSITE PANEL CARRIER SYSTEM

KOMPOZİT KLİPSLİ TAŞIYICI SİSTEM
COMPOSITE CLIP CARRIER SYSTEM

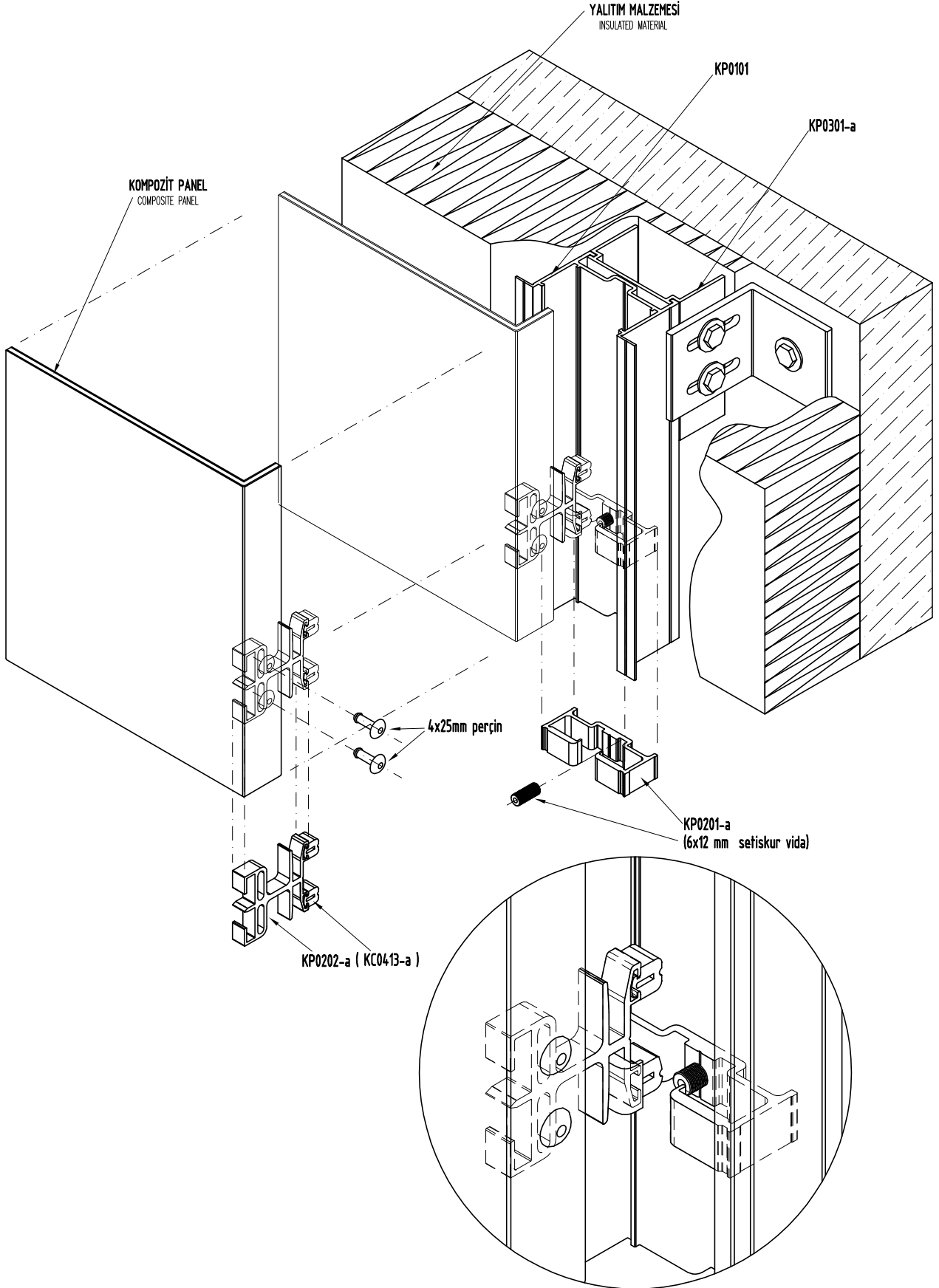

Profil değerleri teoriktir. Ağırlık olarak testimde yapılan tartım geçerlidir.
Profil imalatları TS EN 12020-2 ve TS EN 755-9 toleransı,
Moment değerleri EN 14024'e göre hesaplanmıştır.

Profile values are theoretical pre-shipment weight will be valid.
The tolerances of Profile manufacturing are calculated according to EN 12020-2
and TS EN 755-9; moment values are calculated according to EN 14024.

KP

KOMPOZİT PANEL TAŞIYICI SİSTEMİ
COMPOSITE PANEL CARRIER SYSTEM

ÜRÜN TEKNİK ÖZELLİKLERİ
PRODUCT'S TECHNICAL FEATURES

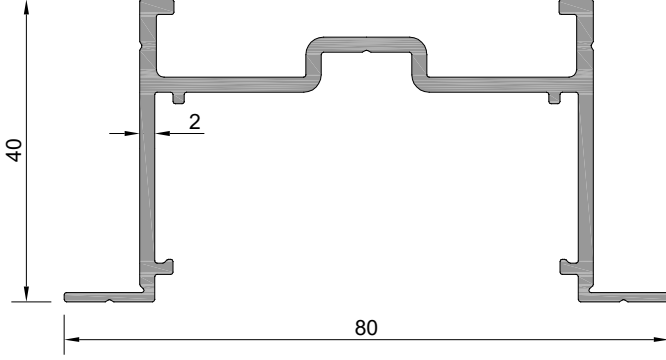

Profil No: KP0101
Ağırlık : 914 gr/m

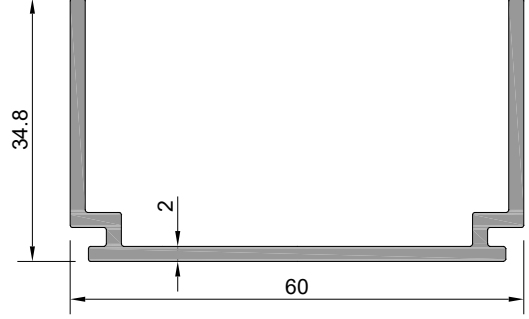

Profil No: KP0301
Ağırlık : 706 gr/m

KP0301-a	80 mm	100 adet/pcs
----------	-------	--------------

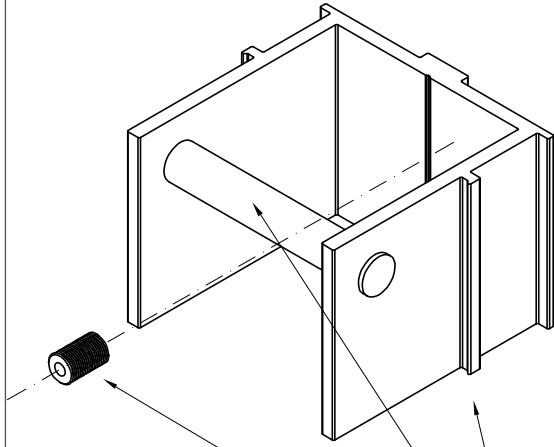

KP0208-a
(8 mm boru profil)
(6x12 mm setiskur vida)

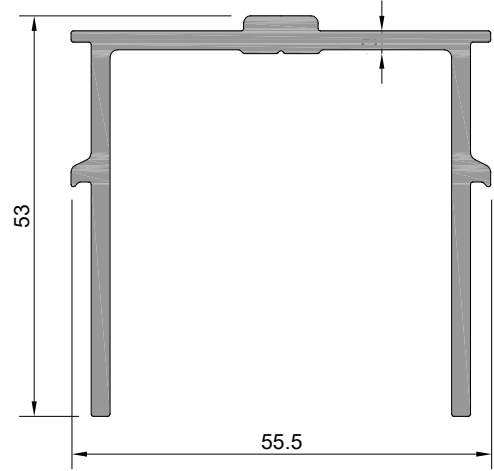

Profil No: KP0208
Ağırlık : 1125 gr/m

KP0208-a	40 mm	100 adet/pcs	8 mm boru profil 6x12 mm setiskur vida
----------	-------	--------------	---

KP
KOMPOZİT PANEL TAŞIYICI SİSTEMİ
COMPOSITE PANEL CARRIER SYSTEM

KOMPOZİT KERTMELİ TAŞIYICI SİSTEM
COMPOSITE NOTCHED CARRIER SYSTEM

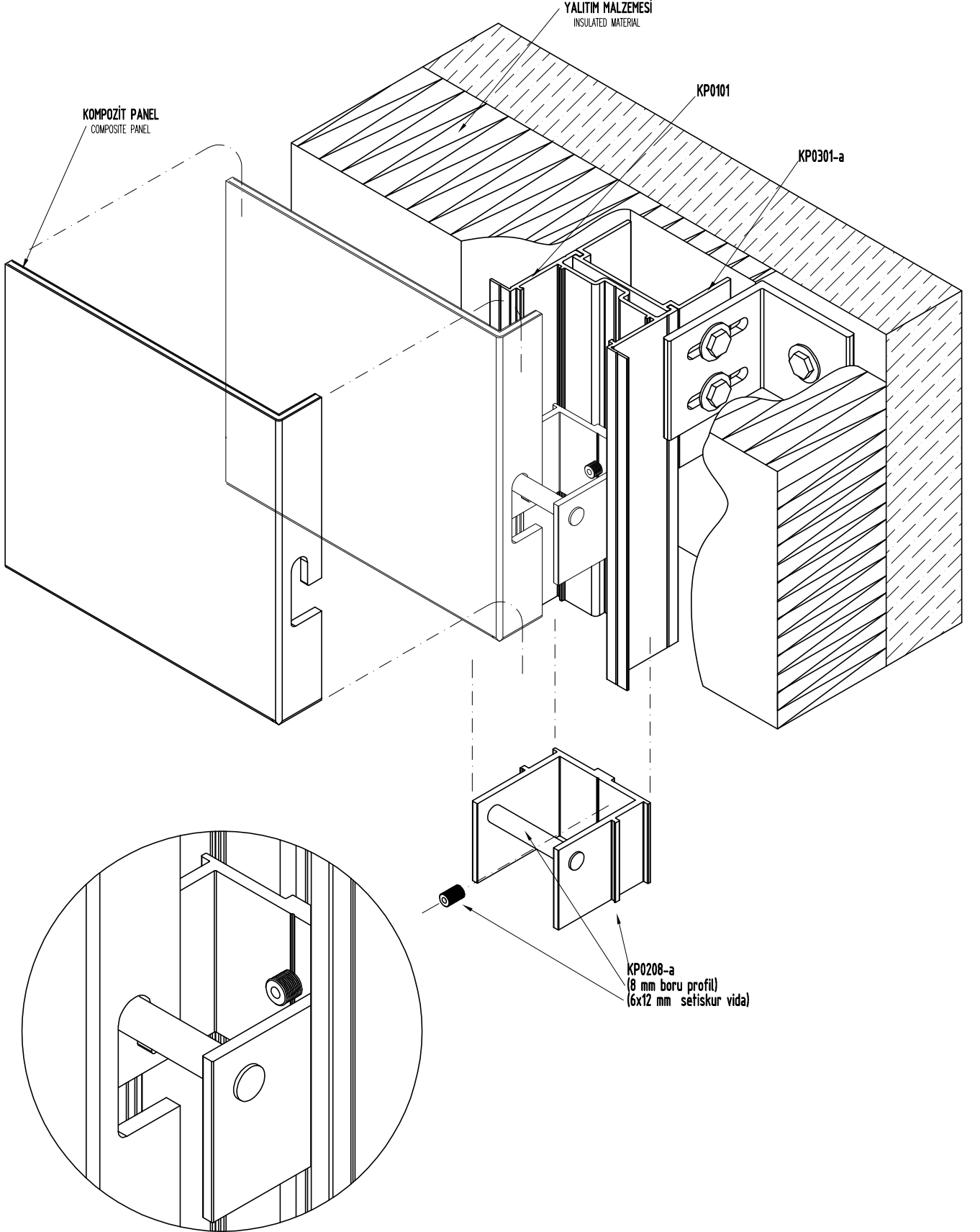

Profil değerleri teoriktir. Ağırlık olarak testimde yapılan tartım geçerlidir.
Profil imalatları TS EN 12020-2 ve TS EN 755-9 toleransı,
Moment değerleri EN 14024'e göre hesaplanmıştır.

Profile values are theoretical pre-shipment weight will be valid.
The tolerances of Profile manufacturing are calculated according to EN 12020-2
and TS EN 755-9; moment values are calculated according to EN 14024.

KP
KOMPOZİT PANEL TAŞIYICI SİSTEMİ
COMPOSITE PANEL CARRIER SYSTEM

ÜRÜN TEKNİK ÖZELLİKLERİ
PRODUCT'S TECHNICAL FEATURES

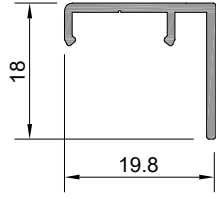

Profil No : KP0209
Ağırlık : 143 gr/m

KP0209-a	50 mm	100 adet/pcs
----------	-------	--------------

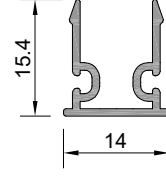

Profil No : KP0210
Ağırlık : 144 gr/m

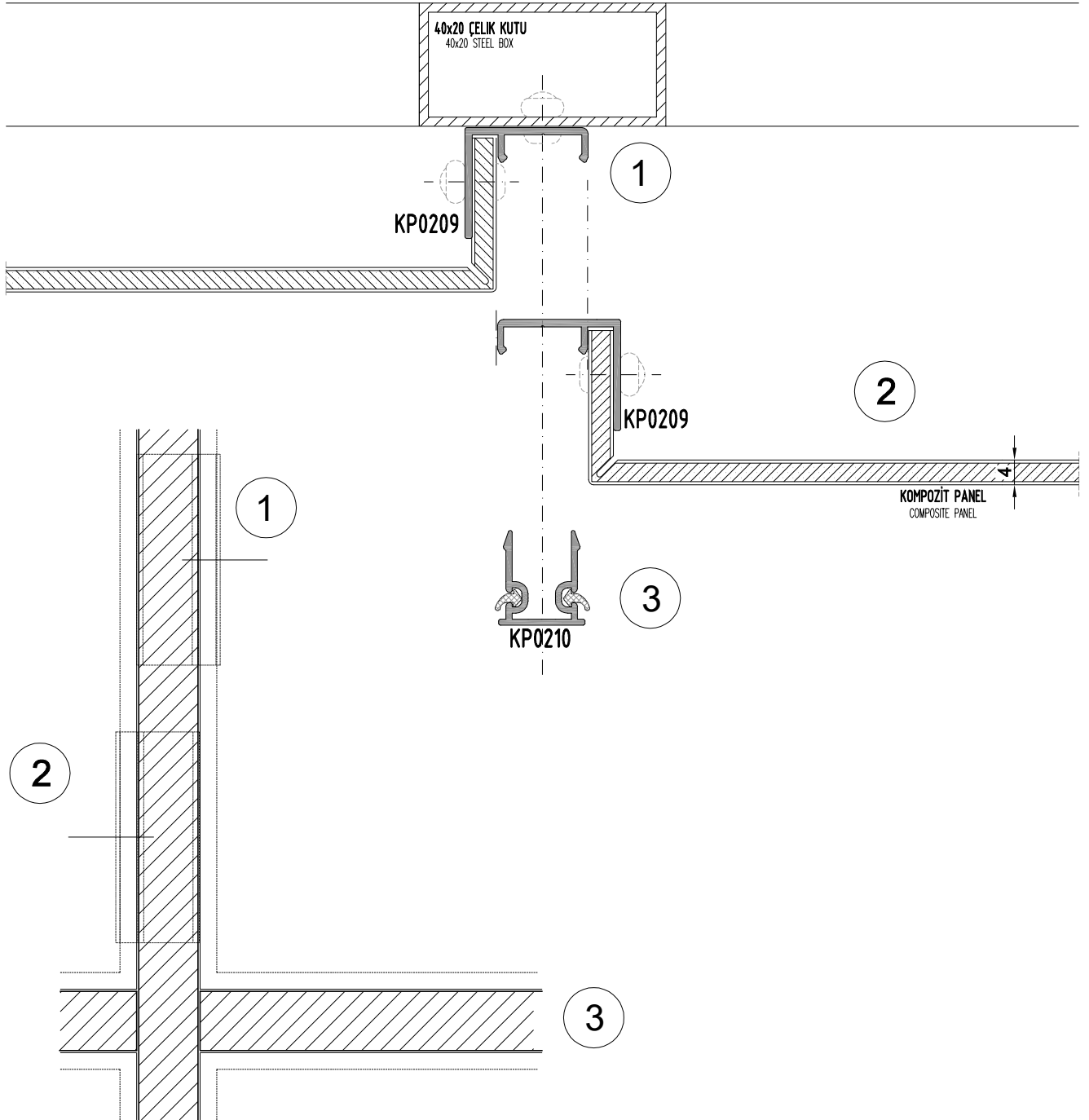

KP
KOMPOZİT PANEL TAŞIYICI SİSTEMİ
COMPOSITE PANEL CARRIER SYSTEM

KOMPOZİT - KOMPOZİT
COMPOSITE-COMPOSITE

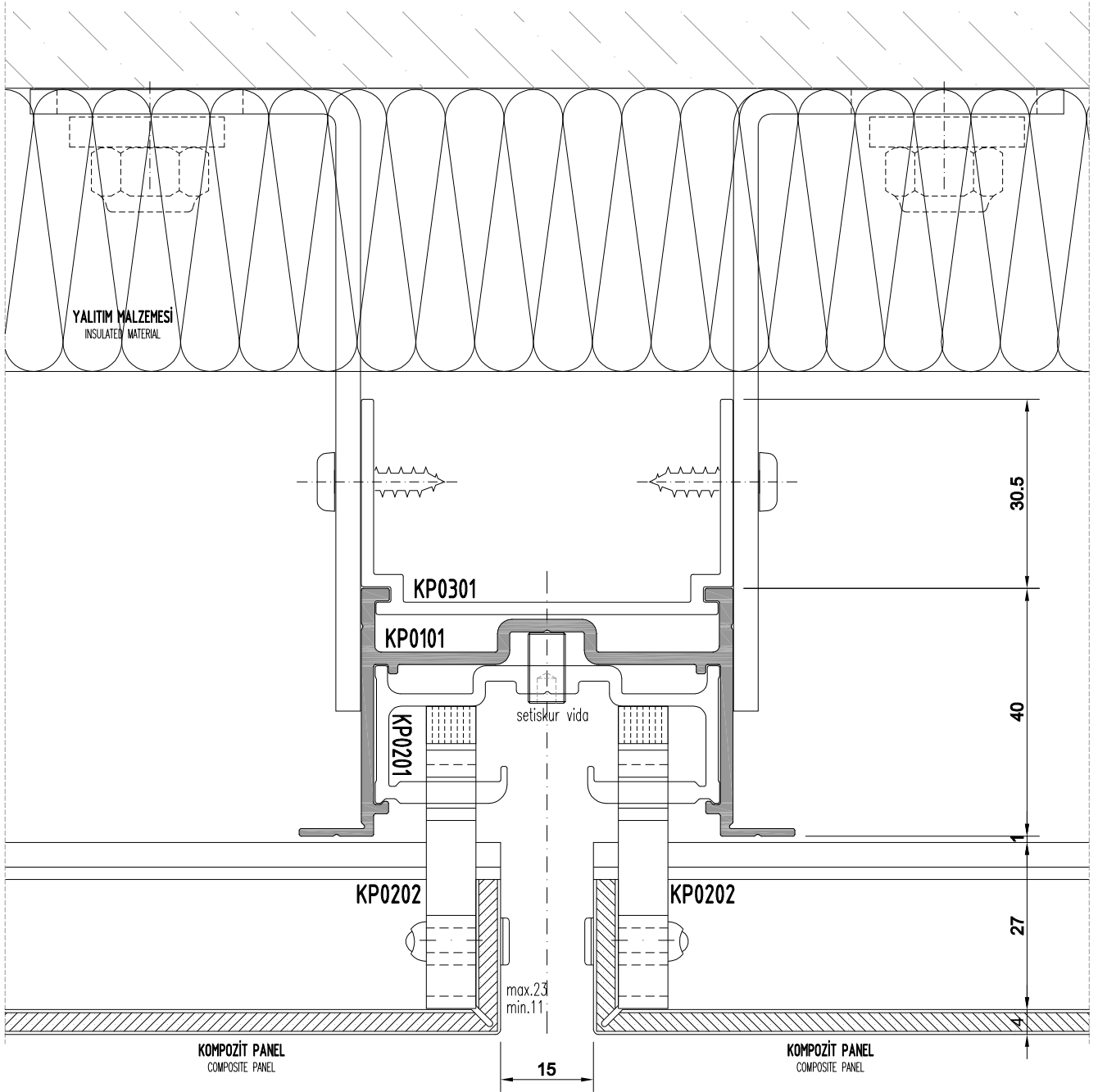
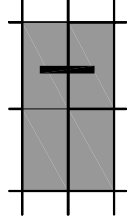

KP
KOMPOZİT PANEL TAŞIYICI SİSTEMİ
COMPOSITE PANEL CARRIER SYSTEM

KOMPOZİT - KOMPOZİT
COMPOSITE-COMPOSITE

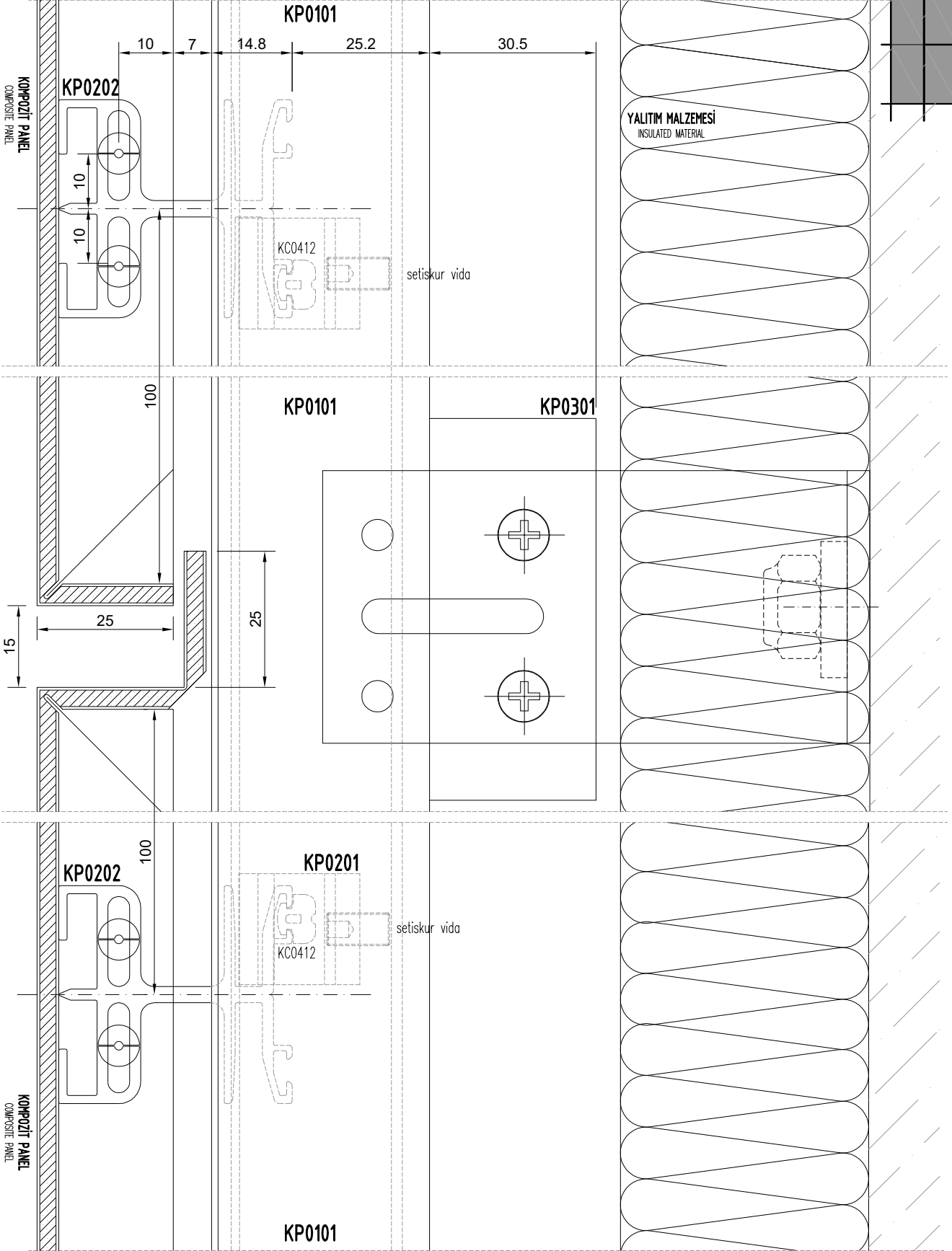
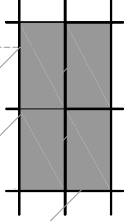

KP
KOMPOZİT PANEL TAŞIYICI SİSTEMİ
COMPOSITE PANEL CARRIER SYSTEM

KÖŞE DETAY
CORNER DETAIL

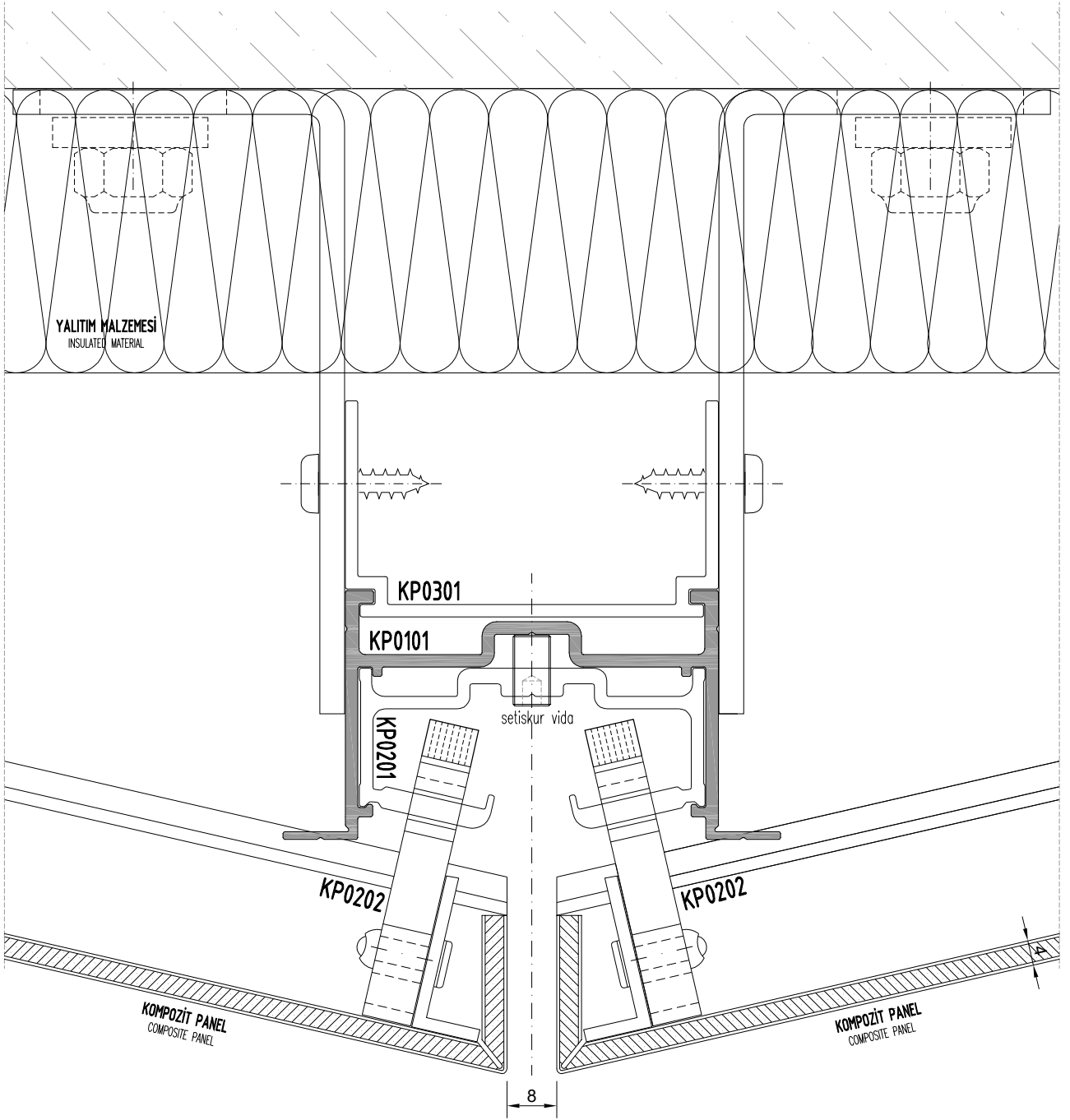
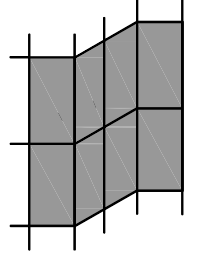

KP
KOMPOZİT PANEL TAŞIYICI SİSTEMİ
COMPOSITE PANEL CARRIER SYSTEM

KÖŞE DETAY
CORNER DETAIL

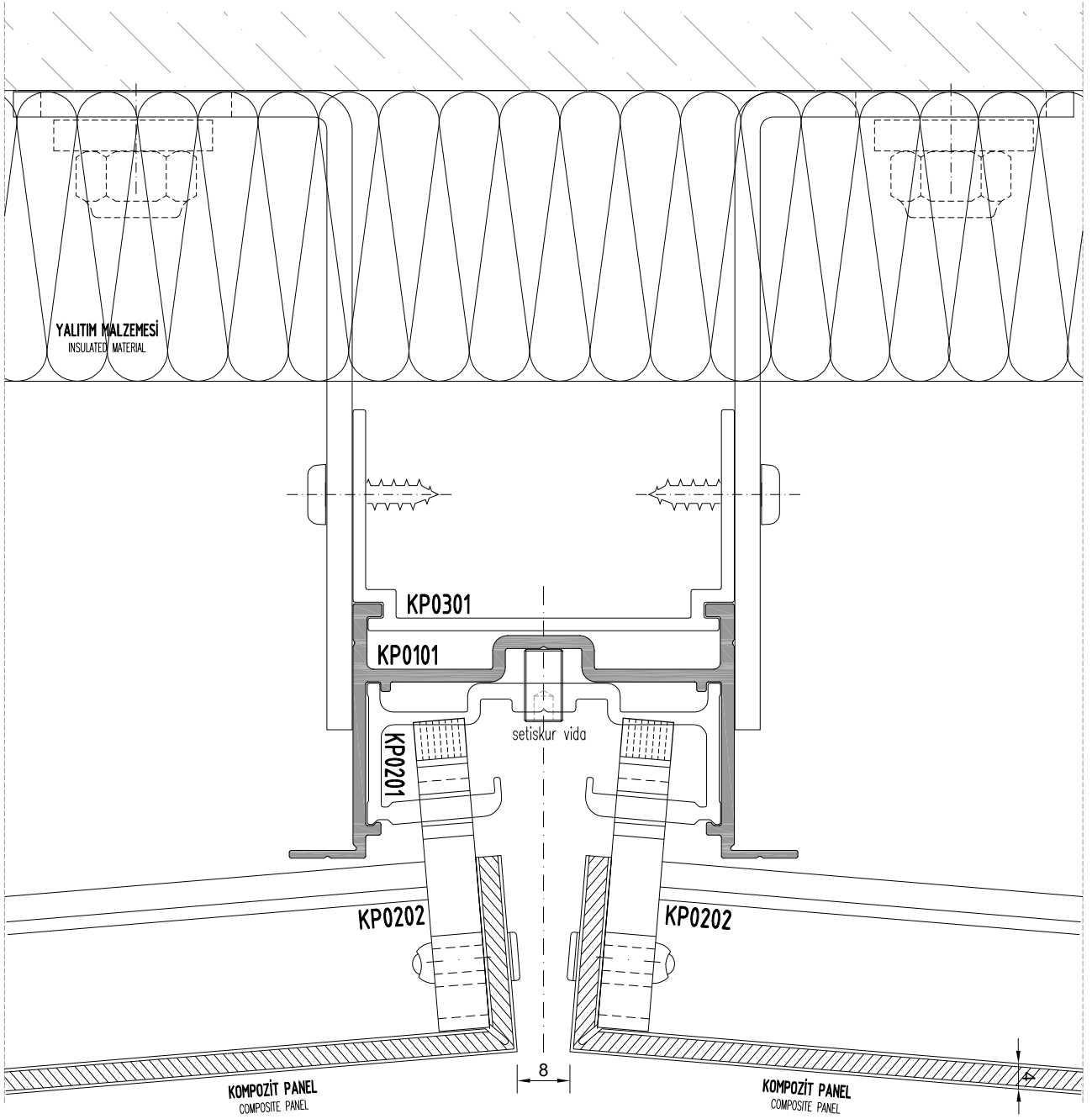
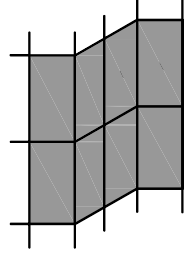

KP
KOMPOZİT PANEL TAŞIYICI SİSTEMİ
COMPOSITE PANEL CARRIER SYSTEM

KOMPOZİT - KOMPOZİT
COMPOSITE-COMPOSITE

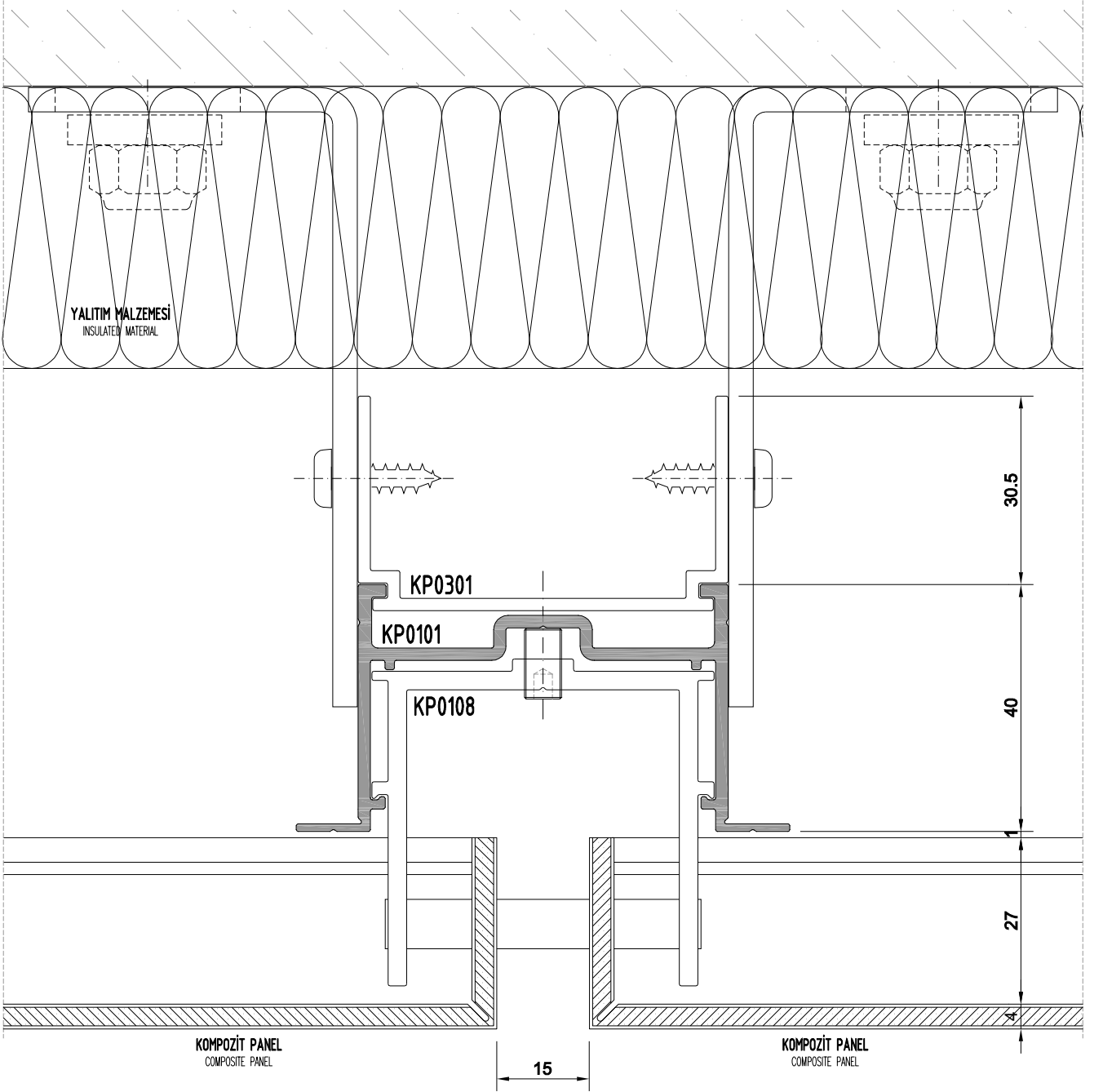
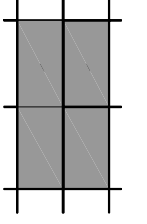

KP
KOMPOZİT PANEL TAŞIYICI SİSTEMİ
COMPOSITE PANEL CARRIER SYSTEM

KOMPOZİT - KOMPOZİT
COMPOSITE-COMPOSITE

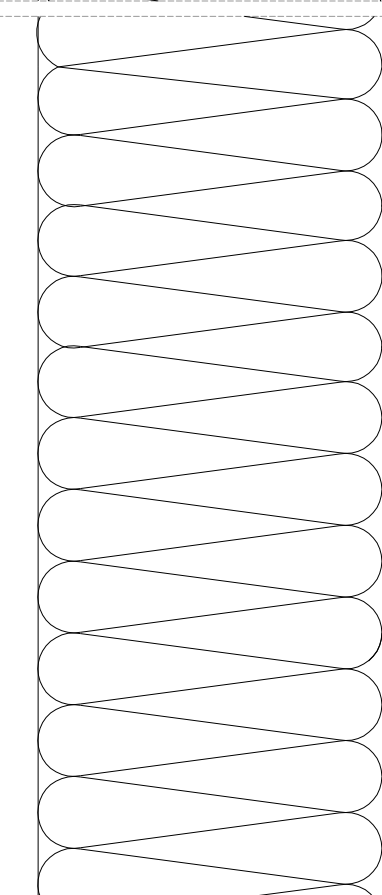
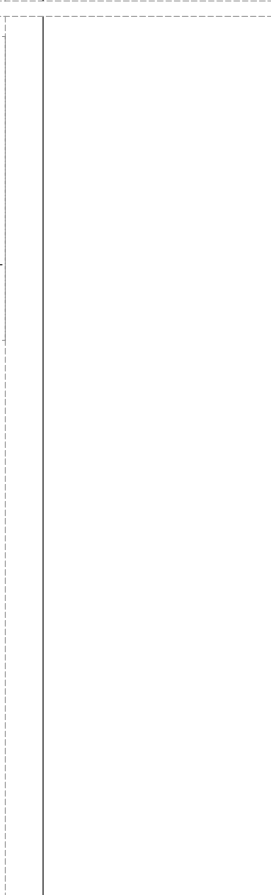
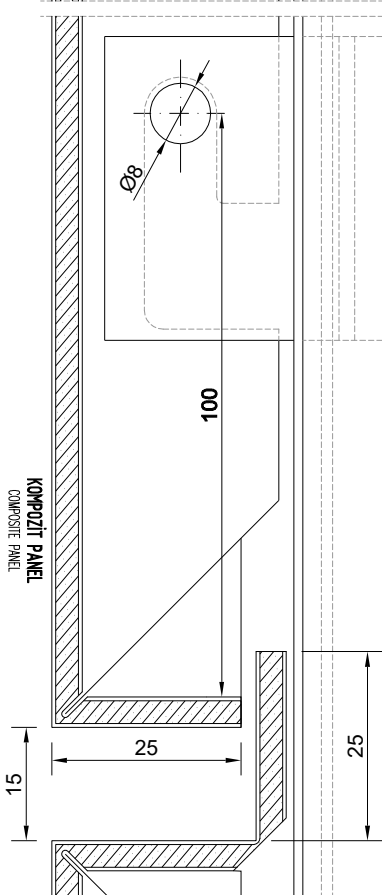
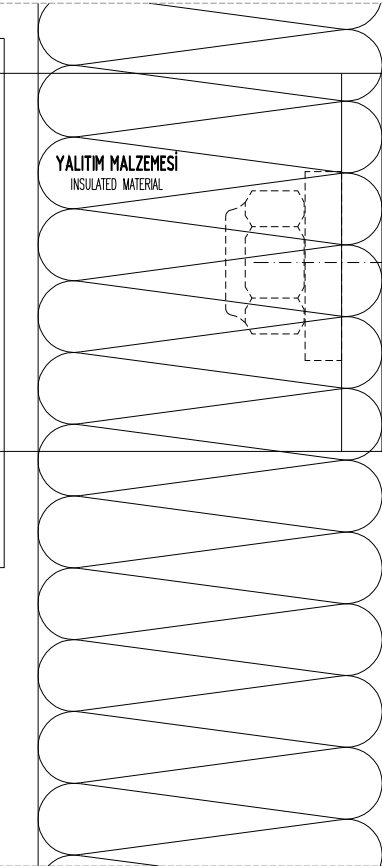
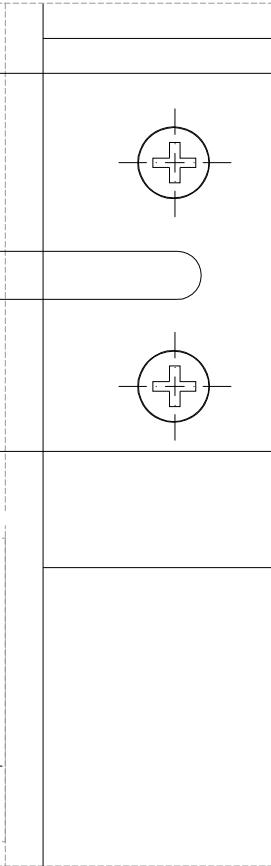
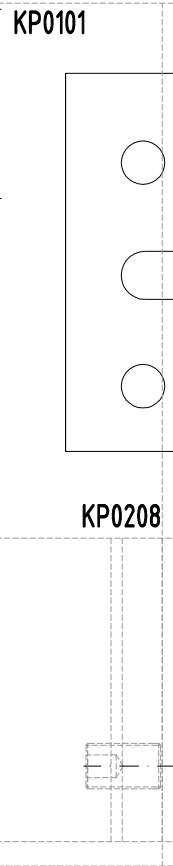
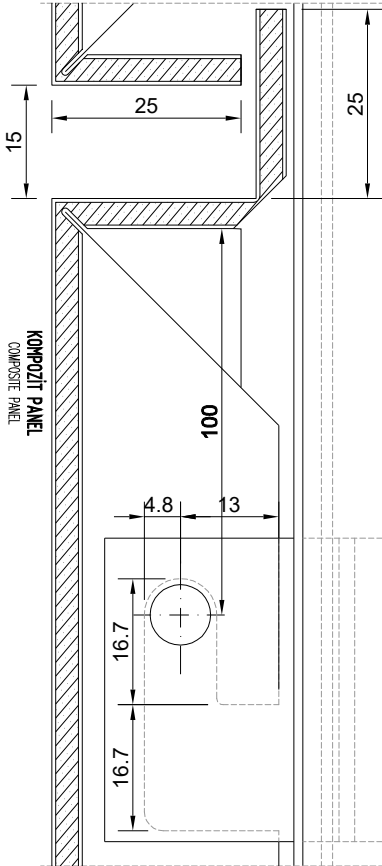

YALITIM MALZEMESİ
INSULATED MATERIAL

KP
KOMPOZİT PANEL TAŞIYICI SİSTEMİ
COMPOSITE PANEL CARRIER SYSTEM

YAN BİTİM VE SABİT DETAY
WALL CONNECTION AND FIXED DETAIL

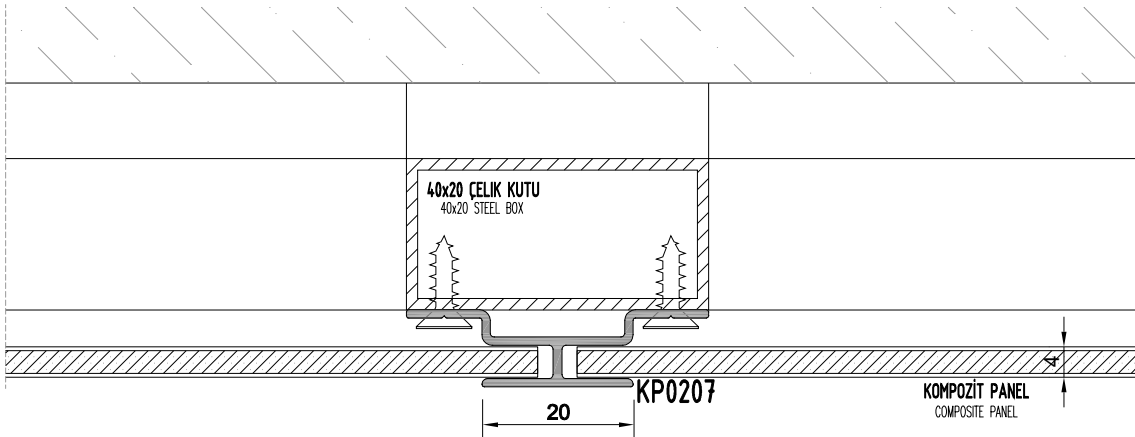
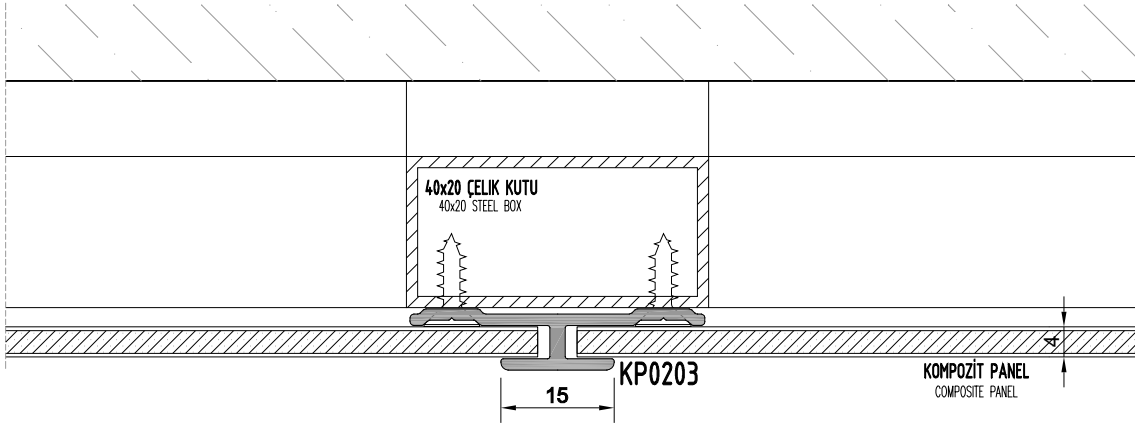
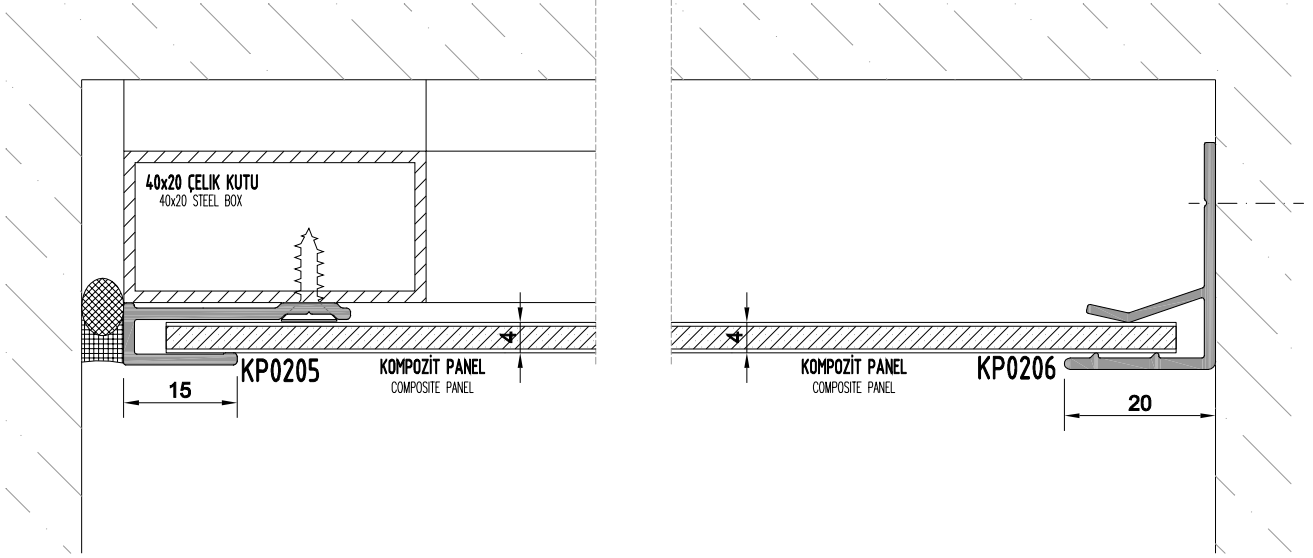

KP
KOMPOZİT PANEL TAŞIYICI SİSTEMİ
COMPOSITE PANEL CARRIER SYSTEM

YAN BİTİM VE SABİT DETAY
WALL CONNECTION AND FIXED DETAIL

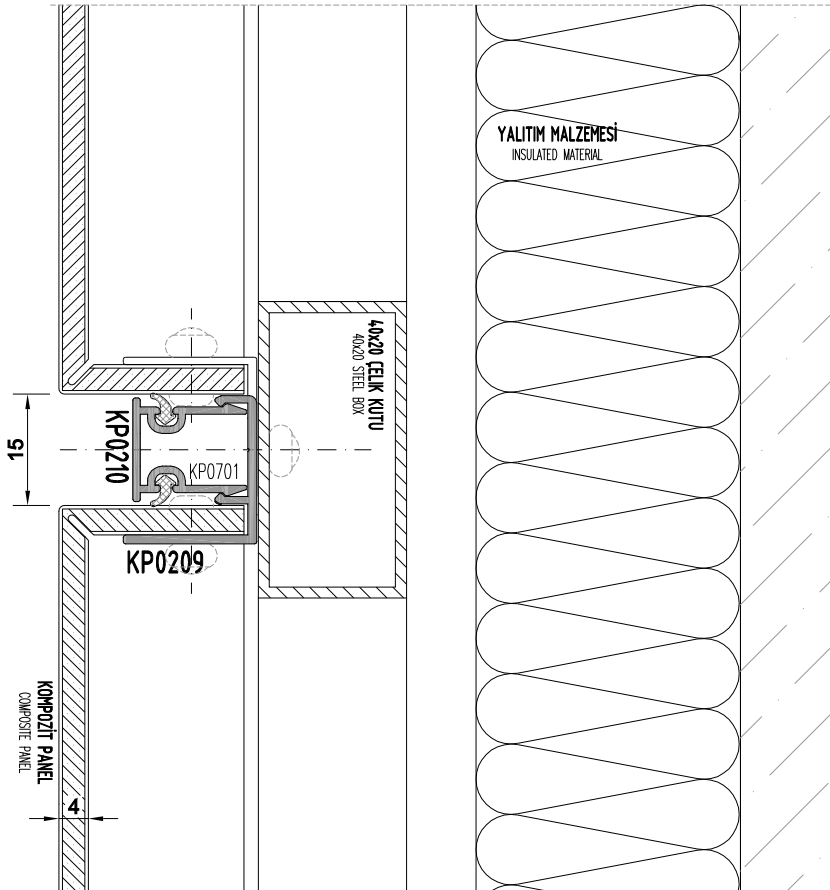
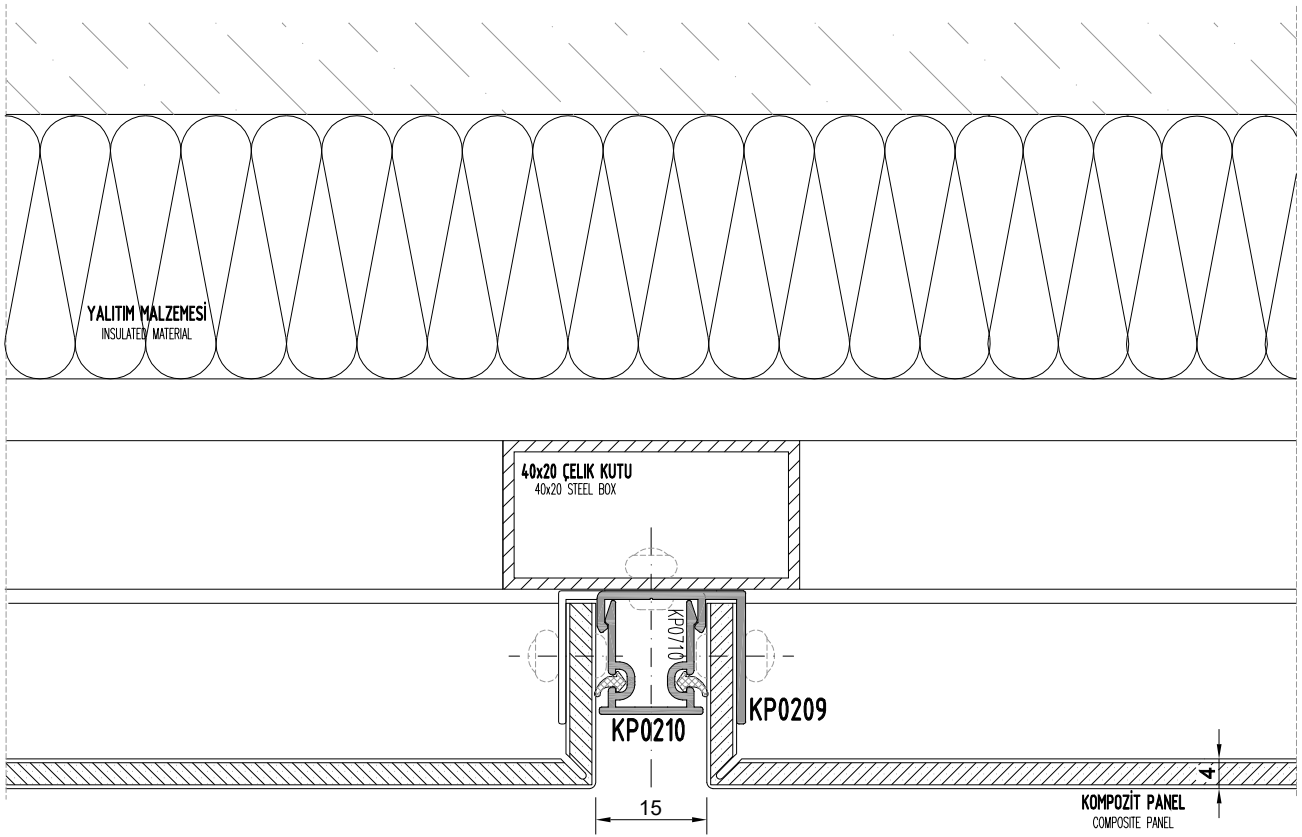

KP**KOMPOZİT PANEL TAŞIYICI SİSTEMİ**
COMPOSITE PANEL CARRIER SYSTEM**Fitil listesi**
Gasket list

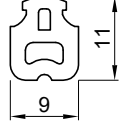
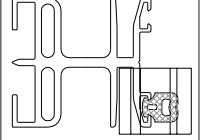
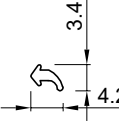
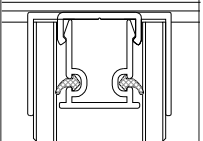
kod code	şekil drawing	tanım description	teorik ağırlık theoretical weight gr / m	paket ağırlığı package weight kg / package	paket metraji in one package metre / package	kullanım yeri aplication
KC0413		Taşıyıcı ön fitili Mullion-transom gasket front	174 gr/m	15 kg	174 m	
KP0701		Profil iç fitil Profile gasket inside	-	-	1 m	

KP
KOMPOZİT PANEL TAŞIYICI SİSTEMİ
COMPOSITE PANEL CARRIER SYSTEM

İMALAT ŞEMASI
PRODUCTION PLAN

